

Reflections on the Effectiveness of Applied Computational Aerodynamics for Aircraft Design

A Perspective on the current status and future prospects based on my journey on a long and winding road for more than five decades

Pradeep Raj, Ph.D.

Collegiate Professor Emeritus

Kevin T. Crofton Department of Aerospace and Ocean Engineering

Virginia Tech, Blacksburg, Virginia, USA

<http://www.aoe.vt.edu/people/emeritus/raj.html>

Program Management Director, Lockheed Martin (Retired)

Deputy Director, Technology Development & Integration

The Skunk Works® , Palmdale, California, USA



05 January 2025

	Slide #
Preface	3
1. Introduction and Scope	11
2. Genesis of Fluid Dynamics (<i>Antiquity to 1750</i>)	52
3. Fluid Dynamics as a Mathematical Science (<i>1750–1900</i>)	77
4. Emergence of Computational Fluid Dynamics (<i>1900–1950</i>)	98
5. Evolution of Applied Computational Aerodynamics (<i>1950–2000</i>)	124
5.1 <i>Infancy through Adolescence (1950–1980)</i>	127
Level I: Linear Potential Methods (LPMs)	127
Level II: Nonlinear Potential Methods (NPMs)	138
5.2 <i>Pursuit of Effectiveness (1980–2000)</i>	163
Level III: Euler Methods	167
Level IV: Reynolds-Averaged Navier-Stokes (RANS) Methods	210
6. ACA Effectiveness: Status and Prospects (<i>2000 and Beyond</i>)	229
6.1 <i>Assessment of Effectiveness (2000–2020)</i>	231
6.2 <i>Prospects for Fully Effective ACA (Beyond 2020)</i>	261
7. Closing Remarks	286
Appendix A	295

ABOUT THE AUTHOR

- **Virginia Tech, Blacksburg, VA (2012-present)**
 - Professor (2012–2017); Collegiate Professor (2017-2024); Collegiate Professor Emeritus (2024-present)
 - Air Vehicle Design, Applied Aerodynamics



Pradeep Raj

- **Lockheed Martin (1979–2011)**



- Technical (1979-1999): Aeronautics Co., California & Georgia
- Leadership/Management (1999-2011): Aeronautics Co., Georgia; Advanced Development Programs, Skunk Works®, Palmdale, California



- **UMR*, Rolla, Missouri**



- Asst. Prof. (1978–79)

**now Missouri S&T University*

- **Ga Tech, Atlanta, Georgia**

- Ph.D. Aerospace Engineering (1976)



- **ISU, Ames, Iowa**

- Res. Asst. Prof. (1976–78)



- **IISc, Bangalore, India**

- M.E. Aeronautical Engr. (1972)
- B.E. Elec. Technology (1970)



- **AIAA Fellow (2011)**



- **Fellow RAeS (2016)**



ROYAL
AERONAUTICAL
SOCIETY

- **FIAE (1991)**



Kelly's Rules for Happy Retirement



1. Retirement is like a job and must be approached as such
2. Don't travel too much, you want to establish a daily grind
3. Don't think about living someplace new, that's why God created hotels
4. Drive till you can't remember where you parked
5. Be pleasantly reckless - but if you have never done it before, now may not be the time to start
6. Don't hang with the children too much - visit, give presents and then move on
7. Maintain your bad habits, but never get drunk more than once a day. You're not a kid anymore
8. Hang with young people; they mostly have it right

Clarence Leonard "Kelly" Johnson (1910-1990) Legendary Aircraft Designer Founder of World-renowned Skunk Works®



P-38 Lightning



P-80 Shooting Star



U-2 Dragon Lady



National Security Medal
1983



SR-71 Blackbird

"Hang with young people; they mostly have it right"

ABOUT THIS PRESENTATION

In this presentation, the author shares his perspective on the evolution of Applied Computational Aerodynamics (ACA), its limited effectiveness today for aircraft design, and prospects for *fully effective ACA** in the future.

**Fully Effective ACA \equiv ACA Nirvana (a goal hoped for but apparently unattainable)!*

The author places the evolution of ACA and its capabilities as well as shortcomings in a historical context, but the presentation is NOT a history of ACA.

This is a much expanded version of the Lead presentation:
Applied Computational Aerodynamics: An Unending Quest for Effectiveness
Royal Aeronautical Society Applied Aerodynamics Conference
The Future of Aerodynamics
Bristol, U.K., July 24-26, 2018

Access the current version using the following URL:

<https://www.aoe.vt.edu/people/emeritus/raj/personal-page/reflections-on-ACA-effectiveness.html>

PUPOSE OF THIS PRESENTATION

To share a relatively complete yet concise perspective on

- *the evolution of applied computational aerodynamics (ACA),*
- *the impressive capabilities of today's ACA for meeting flight vehicle design needs,*
- *the less-than-satisfactory effectiveness of ACA for meeting design needs due to serious shortcomings, and*
- *the future prospects for fully effective ACA capabilities.*

*The perspective reflects **author's 50+ years of related experience***
in aerospace industry and academia.*

**experience is knowledge or skill in a particular job or activity that you have gained because you have done that job or activity for a long time.*

— Collins online dictionary

So what?

Más sabe el diablo por viejo que por diablo.

The devil knows more from being old than from being a devil.

This 'old devil' has much to offer even if you don't agree with everything he says!

An Aside on *Experience*

“experience is direct observation of, or participation in, events as a basis of knowledge”— Merriam-Webster dictionary

C.S. Lewis



29 Nov 1898 – 22 Nov 1963

“Experience: that most brutal of teachers. But you learn, my God do you learn.”

“The only source of knowledge is experience.”

Albert Einstein

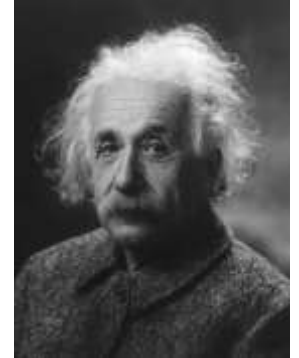

14 Mar 1879 – 18 Apr 1955

“Experience is what you get when you don’t get what you wanted. And it can be the most valuable thing you have to offer.”

Randy Pausch

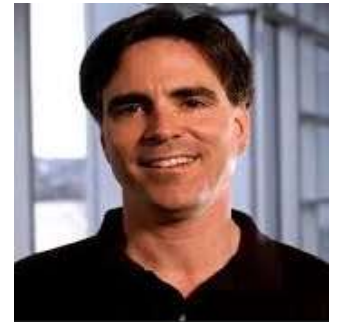

23 Oct 1960 – 25 Jul 2008

Knowledge from experiences is crucial to developing wisdom you need to make good decisions; you can’t get wise overnight from books alone.

“With age comes wisdom, but sometimes age comes alone!”
-- Oscar Wilde

MOTIVATION FOR THIS PRESENTATION

***The primary motivation is to convince budding and practicing engineers using CFD to predict aerodynamic characteristics of aircraft (and of other objects moving through the air) that they must dispel this mistaken notion:
CFD is a commodity now, so we just need to learn to use it for generating aerodynamic data***

- Yes, we know that CFD may be considered a commodity today
- Users can choose from a large number of either commercial or open-source CFD software to simulate aerodynamic flows
- When I assumed the primary responsibility of teaching aircraft design courses at Virginia Tech in 2012, it became apparent rather quickly that
 - a large number of students—just a few months shy of being professionals—used CFD software as a “black box” and chose default input parameters to generate aero data
 - students instinctively trusted the output data, and most never asked: ***“So what that we can predict aerodynamic characteristics. Do the predictions replicate reality?”***

Computational Aerodynamics Engineers Must Learn to Ask and Answer the “So What?” Question!

DISCLAIMERS

The material contained herein reflects the views, thoughts, and convictions solely of the author, and not necessarily those of the author's employers or other groups or individuals.

Being a perspective, the material reflects opinions shaped by author's knowledge, experiences, and biases.

The author has gathered and compiled this material from publicly available sources and personal archives solely for educational purposes. Although a good-faith attempt has been made to cite all sources of material, the author deeply regrets any inadvertent errors or omissions.

	Slide #
Preface	3
1. Introduction and Scope	11
2. Genesis of Fluid Dynamics (<i>Antiquity to 1750</i>)	52
3. Fluid Dynamics as a Mathematical Science (<i>1750–1900</i>)	77
4. Emergence of Computational Fluid Dynamics (<i>1900–1950</i>)	98
5. Evolution of Applied Computational Aerodynamics (<i>1950–2000</i>)	124
5.1 <i>Infancy through Adolescence (1950–1980)</i>	127
Level I: Linear Potential Methods (LPMs)	127
Level II: Nonlinear Potential Methods (NPMs)	138
5.2 <i>Pursuit of Effectiveness (1980–2000)</i>	162
Level III: Euler Methods	166
Level IV: Reynolds-Averaged Navier-Stokes (RANS) Methods	209
6. ACA Effectiveness: Status and Prospects (<i>2000 and Beyond</i>)	230
6.1 <i>Assessment of Effectiveness (2000–2020)</i>	230
6.2 <i>Prospects for Fully Effective ACA (Beyond 2020)</i>	260
7. Closing Remarks	285
Appendix A	294

ACA is an engineering discipline that deals with the application of **Computational Fluid Dynamics (CFD)** to the **analysis and design** of arbitrarily shaped objects moving through the **air**.

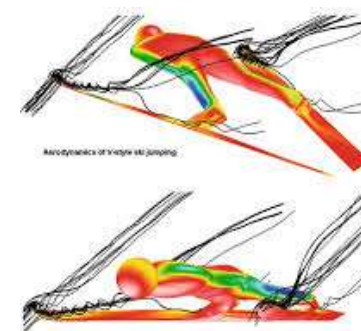
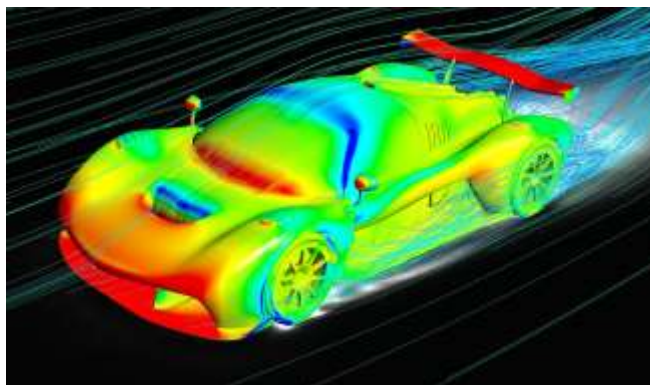
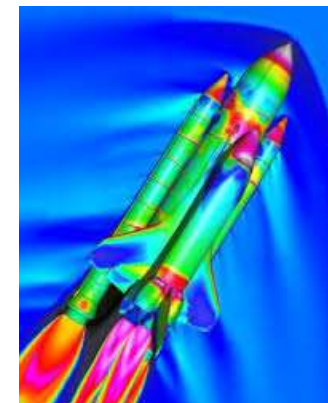
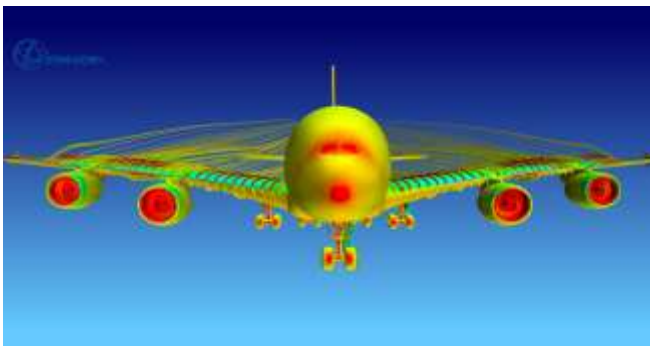
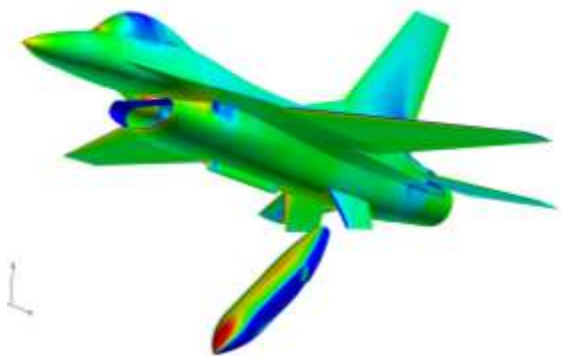

Computational Aerodynamics is CFD when the fluid is air.

Applied Computational Aerodynamics (ACA) puts CFD to *practical use* as opposed to CFD being only theoretical.

Adapted from <https://dictionary.cambridge.org/us/dictionary/english/applied>

Goal of ACA

The overarching goal of applied computational aerodynamics (ACA) is to deliver credible solutions of practical aerodynamic problems—on time and on budget—to engineers designing systems that move through the air, such as aircraft, via aerodynamic analysis and design using computational fluid dynamics (CFD).

ACA is No Longer a Luxury, But a Necessity, to Support Engineering Design of All Types of Systems that Move Through the Air

Don't We Already Know a Lot About CFD and ACA?



Then Why Say It Again?

André Gide

*Everything has been said before,
but **since nobody listens** we
have to keep going back and
beginning all over again.*



French author

Nobel Prize in Literature (1947)

22 November 1869 – 19 February 1951

- It is extremely difficult, if not impossible, for a single book to do justice to the multiple facets of CFD and ACA including theoretical aspects and practical applications.
- **The principal focus of this presentation is on the status and prospects of the effectiveness of ACA for aircraft design.**
- The intention is to **COMPLEMENT, NOT DUPLICATE**, what is extensively covered in many excellent CFD and ACA books.

Scope & Focus of This Presentation

Scope: Discuss ACA in terms of how we got to where we are today, and how we get to where we must be tomorrow with **fully effective ACA** to meet **engineering design** needs of aircraft.

Focus: Examine application of **CFD (computational fluid dynamics)** to aerodynamic problems in the engineering design of aircraft.

Since CFD is applicable to a broad range of problems in **science and engineering**, we use a highly simplified taxonomy of CFD applications to distinguish applications for scientific studies from those for engineering design:

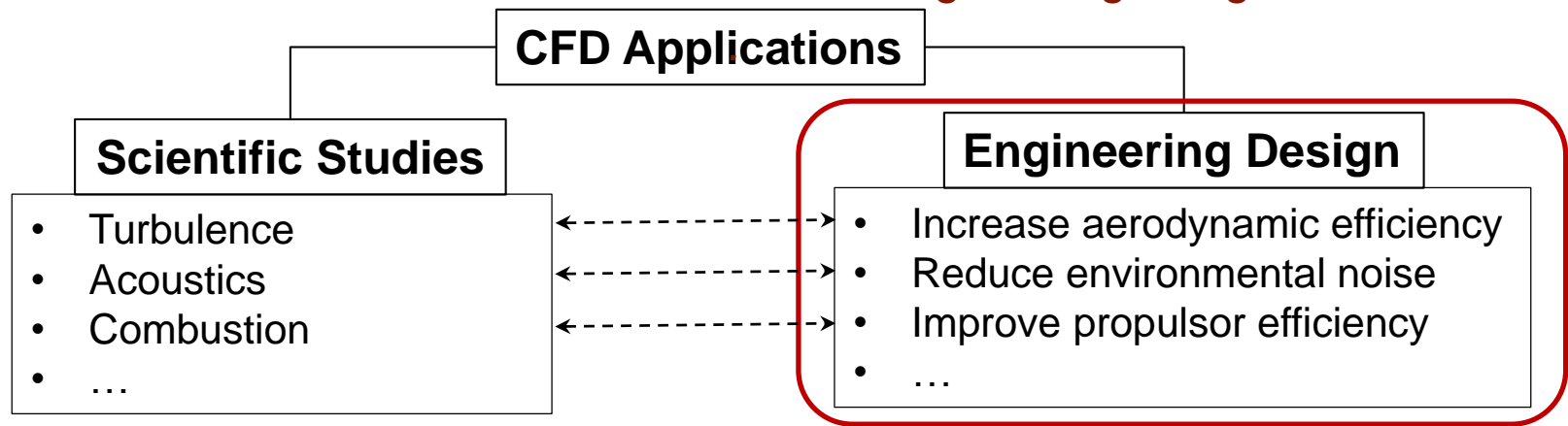

Elaboration of Four Aspects Labeled Above Follows



1. Science and Engineering

“Engineering isn’t Science!”

**Scientists discover the world that exists;
engineers create the world that never was.**

Theodore von Kármán
1881-1963



**Engineering is in the end
about making something.**

Eugene E. Covert, MIT
1926 - 2015

***The Core Purpose of Engineering:
Apply Knowledge and Skills to Develop New Devices***

“An engineer is not a scientist”

“Throughout my years in Cal Tech I like to believe that I gave **engineering education** a little push in the right direction and this helped subsequently in creating the kind of engineers needed in the United States. But eventually a strange thing happened. During those years I had emphasized the importance of physics and chemistry in the engineering curriculum and urged **closer cooperation of science and engineering**. I even suggested **social sciences for engineers** interested in management. So, many educators started to think that *if a little science is good for engineers a whole lot is better*. They gave students more physics and more chemistry, until now the pendulum seems to have swung the other way and **engineering education has become indiscernible from science education.**”

“I am sorry to say that I do not like this trend. **An engineer is not a scientist. In addition to basic technical knowledge he must have the creative capacity to design new hardware.** Engineering schools that fail to recognize and encourage this dual role are remiss in their duty to the profession.”

“Whether we call future scientists physicists or engineers is not important. **What is important I think is to repair the imbalance in the scientific world and turn out people who not only understand fundamental phenomena but can use this knowledge for developing new devices.** This in turn will not only bring some glory to the engineer, but I think it will contribute substantially to the pace of progress.”

-- Theodore von Kármán (1881–1963)

The Wind and Beyond, 1967, pp. 157 & 159

Note: Highlighting by the author of this presentation.

“An Engineer’s Mentality”

“In essence, the current engineering education paradigm consists of giving the students all the data at the top of the page, and the solution (?) consists of rearranging the data on the bottom of the page and handing it in as a “worked” assignment. In many years in industry I never encountered anything even remotely close to this process. ”

“In my experience, *the overwhelming majority of the engineering problem is gathering information and interpreting results.* Although this is the engineering problem it almost never occurs in our science-based engineering education system.”

“**Engineering design** may be the student's only exposure to this process. The student response in evaluations comes across as “problem statements too vague.” If that's the case with these problems, we have not yet helped the students develop an engineer's mentality.”

William H. Mason
AIAA Paper 92-2661

William H. Mason



Professor Emeritus, Virginia Tech
Co-author of an ACA textbook
Engineer Grumman Corp.
19 Jan 1947 - 27 Mar 2019

Note: Highlighting by the author of this presentation.

“An Engineer’s Reality”

“One of the **characteristics of engineers which** I have frequently observed, and which **must be guarded against is** the **search for exact answers**, and the feeling of frustration if the exact answer is not forthcoming. This probably stems from the many years of high school and college training where the answer is always to be found in the back of the book, and the feeling of elation which comes when, after trying several solutions, and looking furtively at the answer, the latest trial finally works.

Unfortunately, **in real life, there are no exact or final answers**. In a job, which must go ahead at a rapid pace, we cannot withhold judgment "until all the facts are in". Rarely is all the evidence at hand. Decisions must be made, and action taken, before complete knowledge can be acquired.

I have for some time thought that **a few of our present day ills stem from this childish faith in the existence of perfect answers**. It requires a degree of maturity to realize that all solutions are partial ones.”



Adm. Hyman G. Rickover (1900–1986)

“Father of the Nuclear Navy,” 63 Years of Active Duty in US Navy
Lecture on *Administering a Large Military Development Project* delivered to
U.S. Naval Postgraduate School, Monterey, CA, 15 March 1954

Note: Highlighting by the author of this presentation.

Engineers Make the World a Better Place!

“Engineers use science to solve problems and make things. Engineering applies a combination of logic and intuition to problem solving...It’s a way of thinking that leaves one well suited to run a company.”

Bill Nye on Sundar Pichai
The 100 Most Influential People
TIME, May 2/May 9, 2016



“Bill Nye the Science Guy”
American Science Educator
Mechanical Engineer



Sundar Pichai
Google CEO

They Meet Highly Challenging Societal Needs!

Aerospace Engineers Shape the Future!

Global Mobility



Shrink the Globe

Global Security



Change the Game

“Engineers Make a Difference!”



2. Computational Fluid Dynamics (CFD)

Computational Fluid Dynamics (CFD): A Subdiscipline of Fluid Dynamics

Fluid Dynamics: The branch of applied science concerned with the movement of fluids (liquids and gases).*

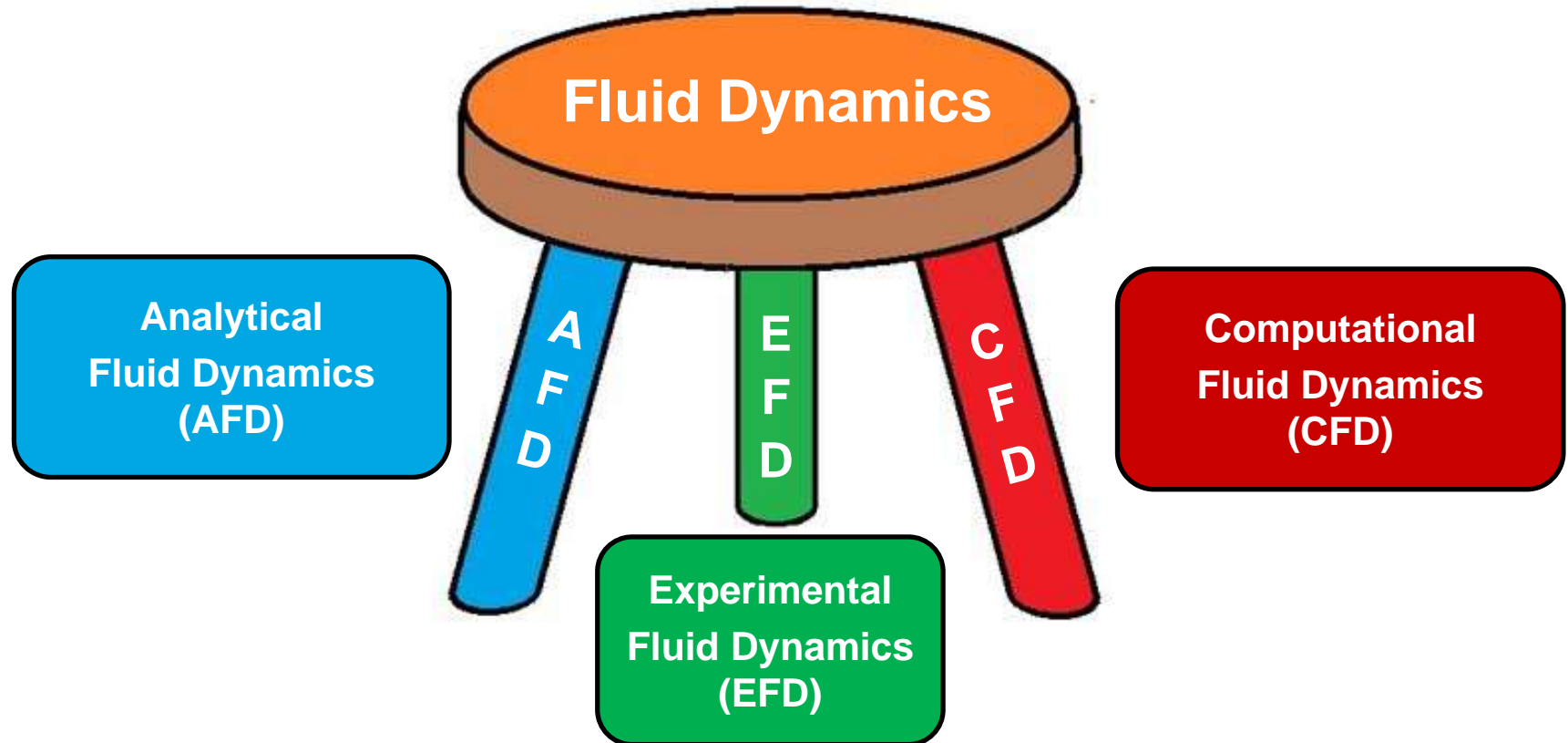

Aerodynamics: *A subset of Fluid Dynamics with air as the fluid.*

Synergistic Use of AFD, EFD, and CFD is Essential for Comprehensive Understanding of Fluid Dynamics

CFD Ingredients

**Governing Equations:
Mathematical Formulations
of Fluid Flow**

*(Partial differential equations in
continuous domain)*

Computer Platforms

*(Digital computers to
run computer programs, and for
data processing & storage)*

CFD

**Numerical Models of
Governing Equations**

*(Difference equations in
discretized domain)*

Computer Programs

*(Software suite based on
algorithms to solve the
difference equations)*

Today's CFD offers a powerful suite of numerical models, computer programs, and associated tools & processes for simulating fluid flows using digital computer platforms.

CFD Offers What We Need To Support Aircraft Design Needs

- **CFD Generates Aerodynamic Data by Simulating Flow About Aircraft and Other Flight Vehicles**
 - New Vehicles (*“clean-sheet” designs*)
 - Derivative Vehicles (*improvements, upgrades and/or modifications*)
- **CFD Enables Multidisciplinary Design Optimization (MDO) Environments to Create Quality, Affordable Flight Vehicles**
 - CFD offers the *most practical* (probably the only?) *means* of producing data required for rapid design closure through extensive multidisciplinary trade-offs
 - CFD affords timely and cost-effective evaluation of the impact of geometric changes on performance, and of sensitivity of performance to *numerous* design variables
 - *CFD provides inverse design and shape optimization capability that most clearly differentiates it from EFD*

CFD Plays a Crucial Role in Engineering Design of Flight Vehicles

Effectiveness: the ability of producing a desired result or a desired output

Richardson, 1910

*“Both for engineering and for many of the less exact sciences, such as biology, there is a demand for rapid methods, easy to be understood and **applicable to unusual equations and irregular bodies**. If they can be accurate, so much the better; but 1 per cent, would suffice for many purposes.”*

Hess and Smith, 1967

“Prospective users...rarely interested in whether or not an accurate solution of an idealized problem can be obtained, but are concerned with how well the calculated flow agrees with the real flow.”

Miranda, 1982

“The effectiveness of computational aerodynamics depends not only on the accuracy of the codes but to a very large degree—perhaps more than is generally appreciated—on their robustness, ease and economy of use.”



3. Engineering Design [of Aircraft]

Designing an Object is a Creative Act

But Creativity Alone May Produce Useless/Impractical Artifacts



The Coffeepot for Masochists



The Camouflage Cup
(cut out plastic cup)



The Uncomfortable Wine Glass

Engineering Design is “Creativity with Purpose!”

“Engineering Design is an iterative decision-making activity performed by team of engineers to produce plans by which resources are converted, preferably optimally, into systems or devices to meet human need.”

-- T.T. Woodson, Introduction to Engineering Design, 1966

Process to Do Engineering Design

Adapted from “*The Mechanical Design Process*” by David G. Ullman

- In engineering design, designer uses **three types of knowledge**
 - A. **knowledge to generate ideas**—comes from experience and natural ability
 - B. **knowledge to evaluate ideas**—comes from domain-specific knowledge
 - C. **knowledge to and make decisions and structure the design process**—largely independent of domain-specific knowledge

- **Six basic actions are taken to solve any design problem**
 - 1) **Establish the need**—what is to be solved
 - 2) **Plan**—how to solve it
 - 3) **Understand the problem**—what the requirements are, and what existing solutions for similar problems are
 - 4) **Generate alternative solutions**
 - 5) **Evaluate the alternative solutions**—compare them to design requirements and to each other
 - 6) **Decide on acceptable solutions**

This Model Works for Entire Product or a Small Piece of It

Traditional Design Process

With rapid increase in aeronautical knowledge in the early 20th century, a three-phase process evolved to systematically guide design of ever more complex aircraft in order to improve chances of achieving target performance

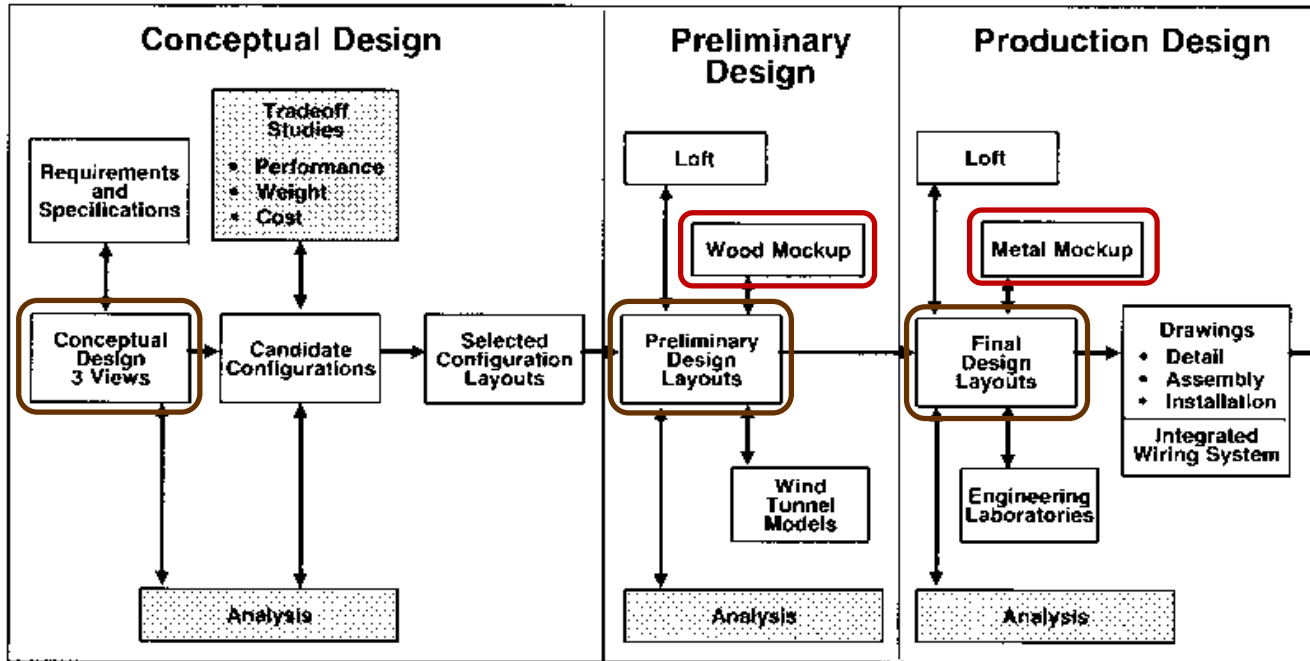

Schematic of
Traditional
Design
Process
ca 1980

*Courtesy of
Sam Smyth,
Experienced
Lockheed
Designer*

Activities in each phase (conceptual, preliminary and production) are dominated by Synthesis (*solution creation*) and Analysis (*feasibility assessment*)

Generation and Evaluation of Ideas Drive the Process

In the Hands of Good Designers, the Traditional Design Process has Delivered...



...An Impressive Array of Aircraft With Phenomenal Performance!

Dramatic Increase in Cost Has Accompanied Increasing Levels of Performance

- With each passing decade since 1903, increasingly sophisticated aircraft emerged to deliver phenomenal performance demanded by customers, but ... **costs also escalated dramatically**

- Boeing 707 (1955) 4 M USD
- Boeing 777-9 (2022) 440 M USD

“[Today’s] Airplanes are some of the most sophisticated designs in the world, four million parts flying in formation, and it involves hundreds of thousands of people all around the world creating these vehicles.”

Alan Mulally, ‘Father of Boeing 777’

(<https://www.nytimes.com/2009/09/06/business/06corner.html>)

- Aircraft industry continues to face a daunting “affordability challenge”
 - Incorporating advanced technologies, such as AI, may further exacerbates the “affordability challenge”

US combat aircraft unit cost has grown 4X every 10 years



Challenge: Develop Technologically Superior Aircraft at Affordable Cost!

A Closer Look at Aircraft Costs

A Representative Military Program

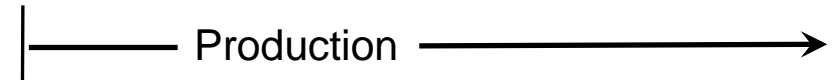
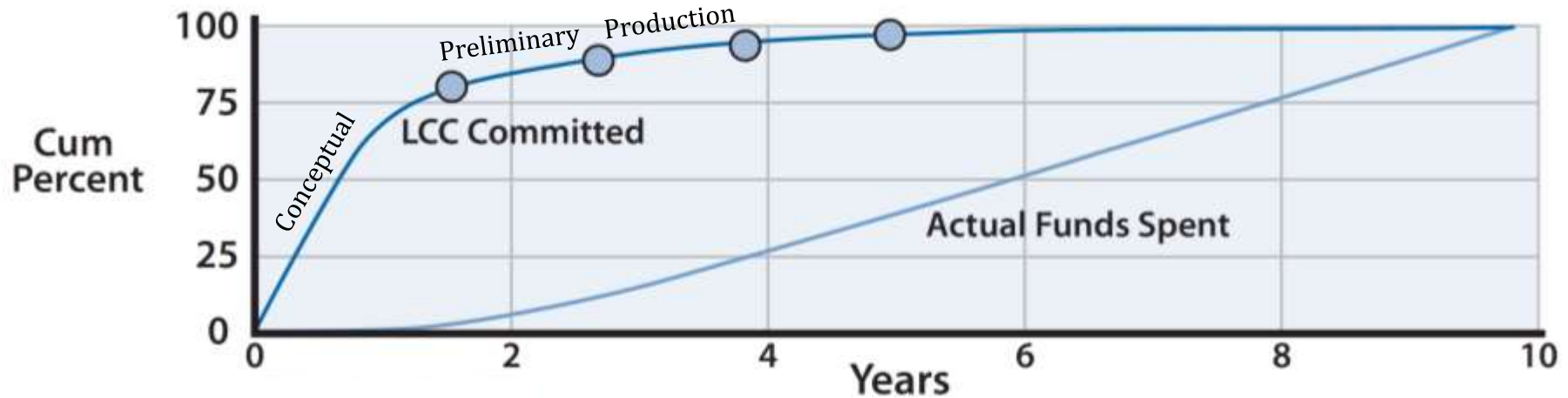

Life Cycle Cost (LCC) =
DT&E + Production + Operations Costs

70% to 75% of (LCC) is Committed in Early Stages of Design!

US DoD Defense Systems Management College, 3 Dec 1991

Decisions in Early Stages of Design Have a Disproportionately Large Impact on Aircraft's LCC

Key to Affordable Designs

- Successful engineering design requires that quality decisions be made in a timely manner
- Quality decisions require credible data at the right time and the right cost

RELATIVE COST
OF MAJOR
AERODYNAMIC
CONFIGURATION
CHANGE

- The later a major configuration change is made, the higher the cost—*exponentially higher!*

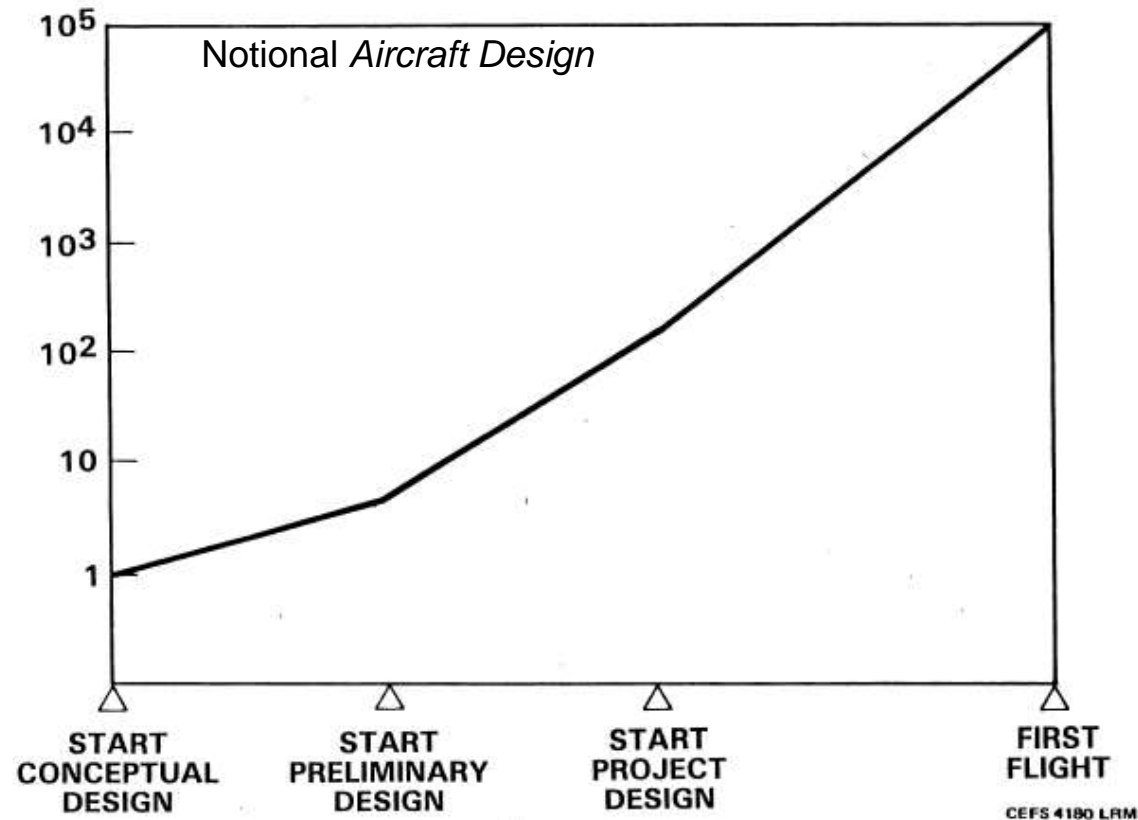

Quality Decisions Early ➔ **Better Quality Affordable Product Later**

Traditional Design Process

A Few Undesirable Characteristics Hamper Affordable Designs

- **Large Disciplinary Groups:** From 1920s to 1980s, Disciplinary Groups grew in size due to the need to address ever increasing complexity of designs, and operated in a “*stovepipe*” environment with “*Throw it over the wall*” mindset
 - Much time spent in reconciling design changes proposed by various disciplines and cost went up
- **Long Cycle Times and High Cost:** Sequential nature of the process led to long elapsed time and high cost for completing each design cycle
- **Simplistic Methods for Analyses:** Decisions in early stages of design based on data from simplistic analyses to accommodate schedule and cost constraints
- **Not All Disciplines Adequately Considered:** Design activities did not adequately incorporate manufacturing, operations and support considerations
- **Very Few Candidate Designs Fully Explored:** Schedule and cost constraints limited the number of designs that could be fully explored in early stages
 - Not well suited for designing “optimal” configurations

Design Community Proposed New Paradigms to Address Undesirable Characteristics

Novel Design Paradigms

Proposed to Address Undesirable Characteristics of Traditional Design Process

1980s: *Concurrent Engineering*

1990s: *Integrated Product & Process Development (IPPD) Concept*

Key Attributes of IPPD

- **Closer Relationship with Customer**
 - Better Understanding of Customer Requirements
- **Integrated Product Teams (IPTs)**
 - More Complete Understanding of Requirements
 - Broader and Balanced Discussion of Alternatives
 - Simultaneous Design of Product and Process
- **'Design for X' Methods**
 - Design for Manufacturability, Producibility, Maintainability, Reliability, Safety, Quality, Cost, etc.
- **Digital Product Model**
 - Integrate Design and Analysis Tools to Capture and Refine Product and Process Data
- **Integrated Design Automation Tools**
 - Streamline the Design Process and, Assure Understanding of Design Intent
- **Extensive Use of Physics-based Methods and Simulation Tools**
 - Achieve Improved Product Performance with Fewer Design/Build/Test Iterations

Simulation Based Design (SBD)

Implements *Integrated Product & Process Development (IPPD)* concept using *Multidisciplinary Design Optimization (MDO)* methodology

- SBD employs integrated multidisciplinary models and computational simulations to develop Virtual Prototypes (aka Digital Twins)
- Considers all aspects including manufacturing, operations and support simultaneously with all requirements and constraints from start
- Reduces chances of design changes in later stages
- Conducts cost/performance trade-offs EARLY Using more Knowledge about designs

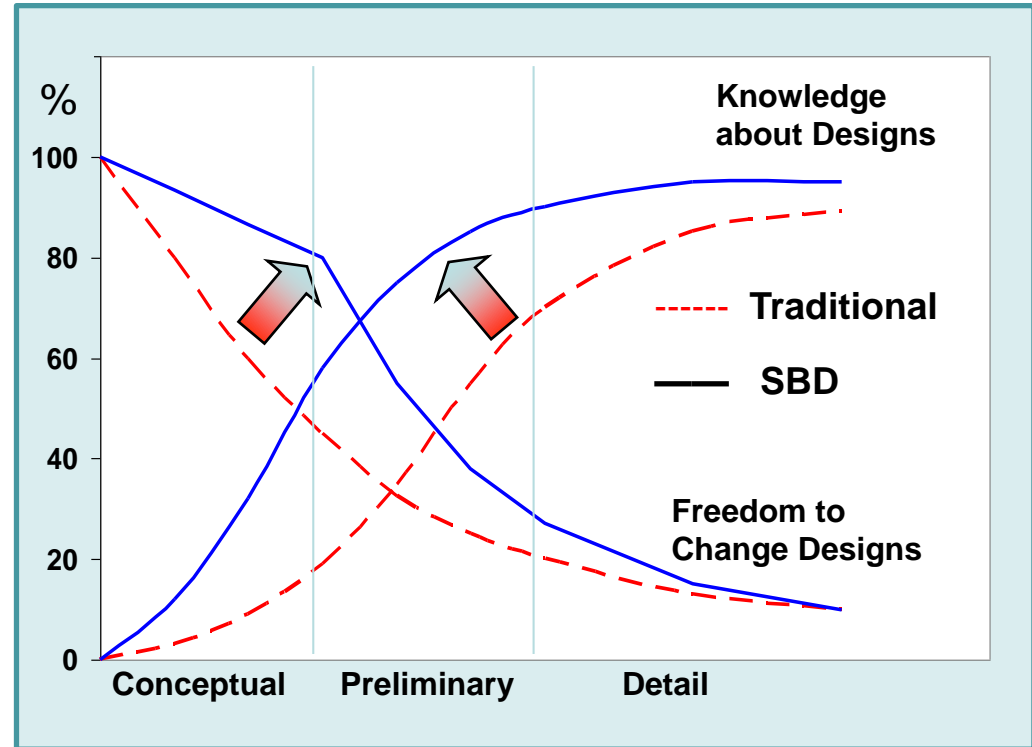

SBD relies on computational methods as the primary means of all data required to make design decisions

A Paradigm for Designing Quality Affordable Vehicles

MDO Methodology for SBD of Aircraft

Multidisciplinary Design Optimization (MDO) Methodology *Best Suited for Simulation Based Design*

Geometry	Cowl and Inlet Shape	Outer Mold Line	Cowl, Aft Deck	Internal Struc. Configuration	Mass Distribution	Wing Planform		Configuration
Flow behind Inlet Shocks	Propulsion	Inlet and nozzle Flow	Engine Thermal Loads	Engine Mechanical Loads	Engine Weight and Location	Engine Deck		Thrust, Altitude, Mach #, BPR, etc.
		Aerodynamics	Skin Temp., Loading	Airloads and Aeroelasticity		Polars in Flight Envelope		Response surface model
		Aero (Empirical)	Thermal Management	EEWS Weight, Inertial Loads	EEWS Weight			
		Aero (Linear Potential)		Structures	Structural Weight – Other	Flexible Wing		Response surface model
		Aero (Euler and RANS)			Weights	Weight in Flight Envelope		Take-off Gross Weight
		Aero (Wind tunnel tests)				Flight Performance		Feasibility
							Discipline X...	
Configuration	Thrust, Altitude, Mach#, BPR							Optimization

High Levels of Models Low

Enables Extensive Trade-off Studies and Rapid Design Closure

Aerodynamic Data Generation for Design

Two Primary Means Today: EFD and CFD

	EFD (Experimental Fluid Dynamics)	CFD (Computational Fluid Dynamics)
Strengths	<ul style="list-style-type: none"> • Perceived as “Real” • Credible data <ul style="list-style-type: none"> ▪ Quantified uncertainties • Large excursions per entry 	<ul style="list-style-type: none"> • Low cost • Quick turnaround • No scale effects • No wall interference effects • No support interference effects • Can model aeroelastic distortions • Applicable to <u>all</u> flight conditions
Weaknesses	<ul style="list-style-type: none"> • Higher cost, longer elapsed time • Scale effects • Wall interference effects • Support interference effects • Aeroelastic distortions • Not practical for <u>some</u> flight conditions 	<ul style="list-style-type: none"> • Perceived as “Virtual” • Lack of credibility due to <ul style="list-style-type: none"> ▪ Computational uncertainties caused by limitations or deficiencies in Numerical Models and Flow Physics Models

EFD and CFD Have Highly Complementary Strengths

- **New Vehicles (“clean-sheet” designs)**
 - *Outer Mold Line (OML) Design:* Forces, moments, and surface pressure distributions
 - *Shape Optimization:* Sensitivity of aerodynamic data to design variables
 - *Flight Performance Prediction:* Data to validate take-off, climb, cruise, maneuver, descent, landing
 - *Airframe Propulsion Integration:* Data to minimize installation losses
 - *System Integration:* Off-body flow field for safe carriage and deployment of stores & weapons
 - *Structural Design:* Steady and unsteady flight loads
 - *Flight Control System Design:* Stability & Control coefficients and rate derivatives
 - Etc.
- **Derivative Vehicles (improvements, upgrades and/or modifications)**
 - Aerodynamic data to assess impact of shape change on performance when integrating new or improved subsystems to upgrade current product or design a derivative

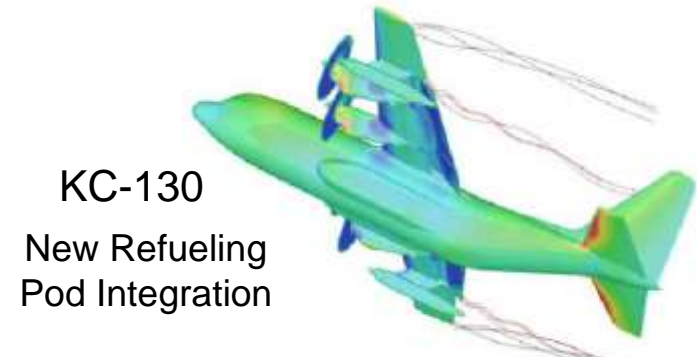
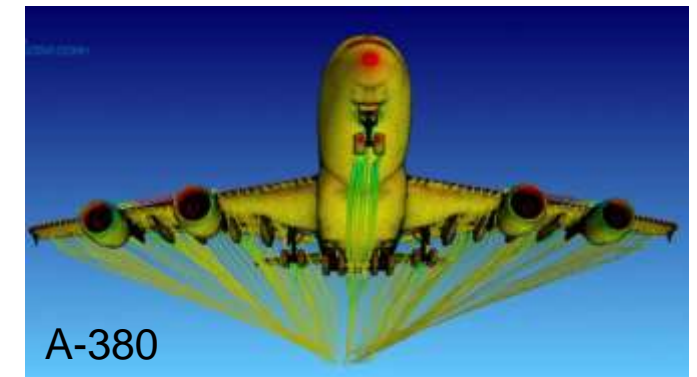
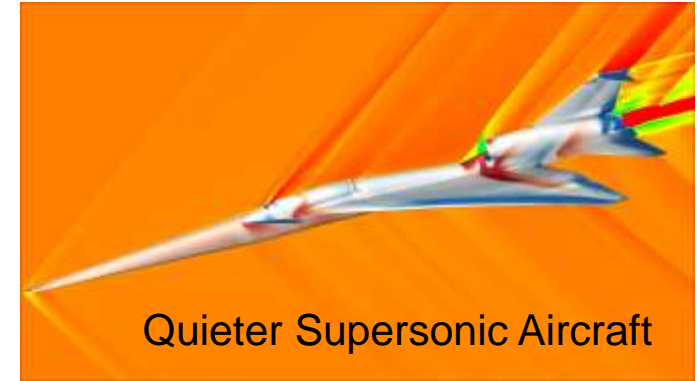

Success Hinges on Credible Data On Time & On Budget

Role of CFD in MDO Methodology

CFD Enables Use of Multidisciplinary Design Optimization (MDO) Methodology for SBD to Create Quality, Affordable Flight Vehicles

- CFD provides aerodynamic data for timely and cost-effective evaluation of the impact of geometric changes on vehicle performance, and of the sensitivity of performance to numerous design variables
- CFD offers the *most practical* (probably the only?) *means* of producing data required for rapid design closure through extensive trade-offs

Geometry	Cowl and Inlet Shape	Outer Mold Line	Cowl, Aft Deck	Internal Struct. Configuration	Mass Distribution	Wing Planform		Configuration
Flow behind Inlet Shocks	Propulsion	Inlet and nozzle Flow	Engine Thermal Loads	Engine Mechanical Loads	Engine Weight and Location	Engine Deck		Thrust, Altitude, Mach #, BPR, etc.
		Aerodynamics	Skin Temp., Loading	Airloads and Aeroelasticity		Polars in Flight Envelope		Response surface model
		Aero (Empirical)	Thermal Management	EEWS Weight, Inertial Loads	EEWS Weight			Response surface model
		Aero (Linear Potential)		Structures	Structural Weight - Other	Flexible Wing		Take-off Gross Weight
		Aero (Euler and RANS)			Weights	Weight in Flight Envelope		Feasibility
		Aero (Wind tunnel tests)				Flight Performance		Discipline X...
Configuration	Thrust, Altitude, Mach#, BPR							Optimization

High Levels of Models Low

CFD provides inverse design and shape optimization capability that most clearly differentiates it from EFD

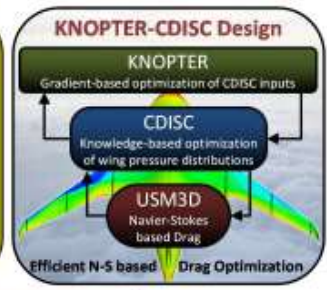
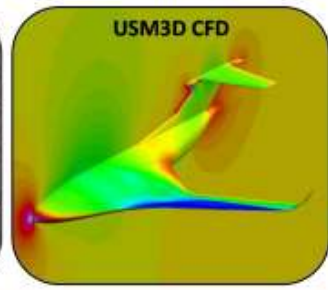
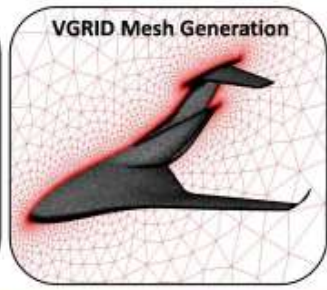

Rapid Navier-Stokes CFD Analysis, Design, & Optimization

Enabler for Optimal Outer Mold Line (OML) Design

4. Fully Effective ACA

CFD and ACA are NOT Synonymous

CFD Produces Data.

Computational Fluid Dynamics (CFD) offers a powerful means of generating aerodynamic data, à la wind tunnels, for bodies moving through air.

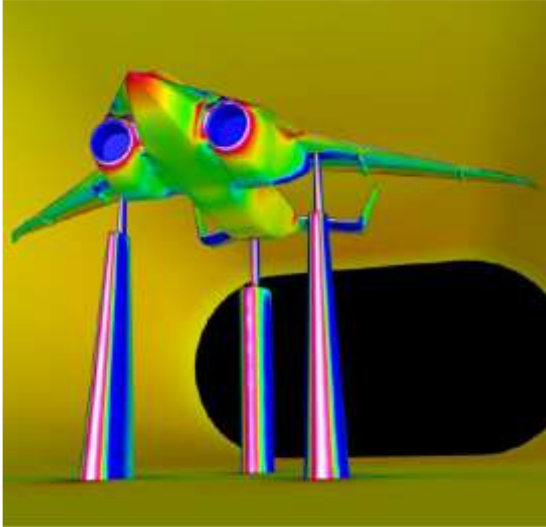

Both use a 3-step process

1. Build a model
2. Blow air on it
3. Gather and interpret data

*(Data include:
forces, moments, and
flow quantities—on and off the surface)*



ACA Produces Solutions!

Applied Computational Aerodynamics (ACA) is all about using CFD to deliver credible solutions of engineering problems to designers.

***Solving Engineering Problems Needs Aerodynamic Data,
But Don't Confuse Data with Solutions!***

Relationship of CFD to ACA

CFD is to ACA as Airplane is to Air Transportation!

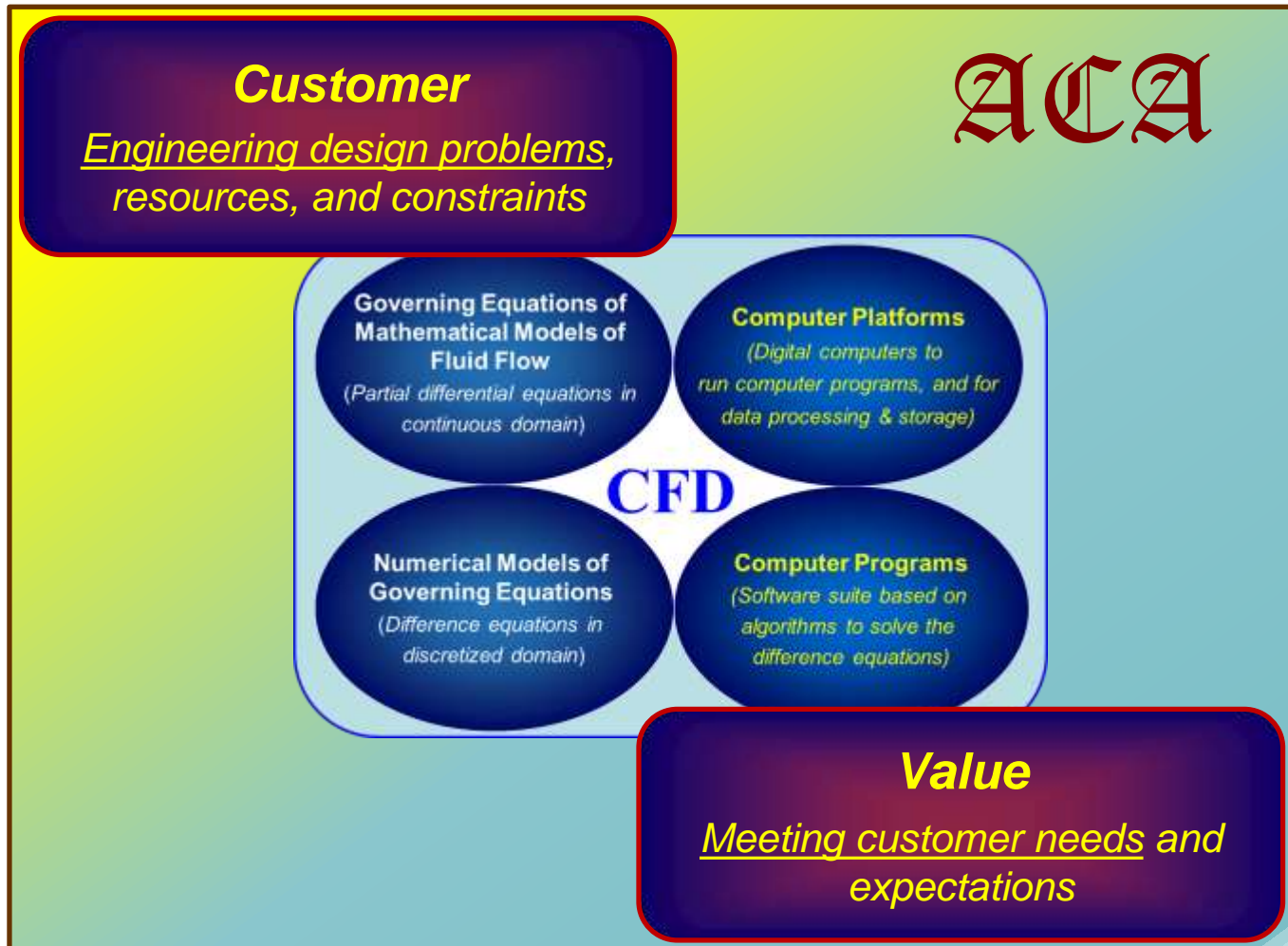

ACA Uses CFD to Create Value for the Customer

Role of ACA in Aircraft Design

“A Simplified Aerodynamic Design Loop”

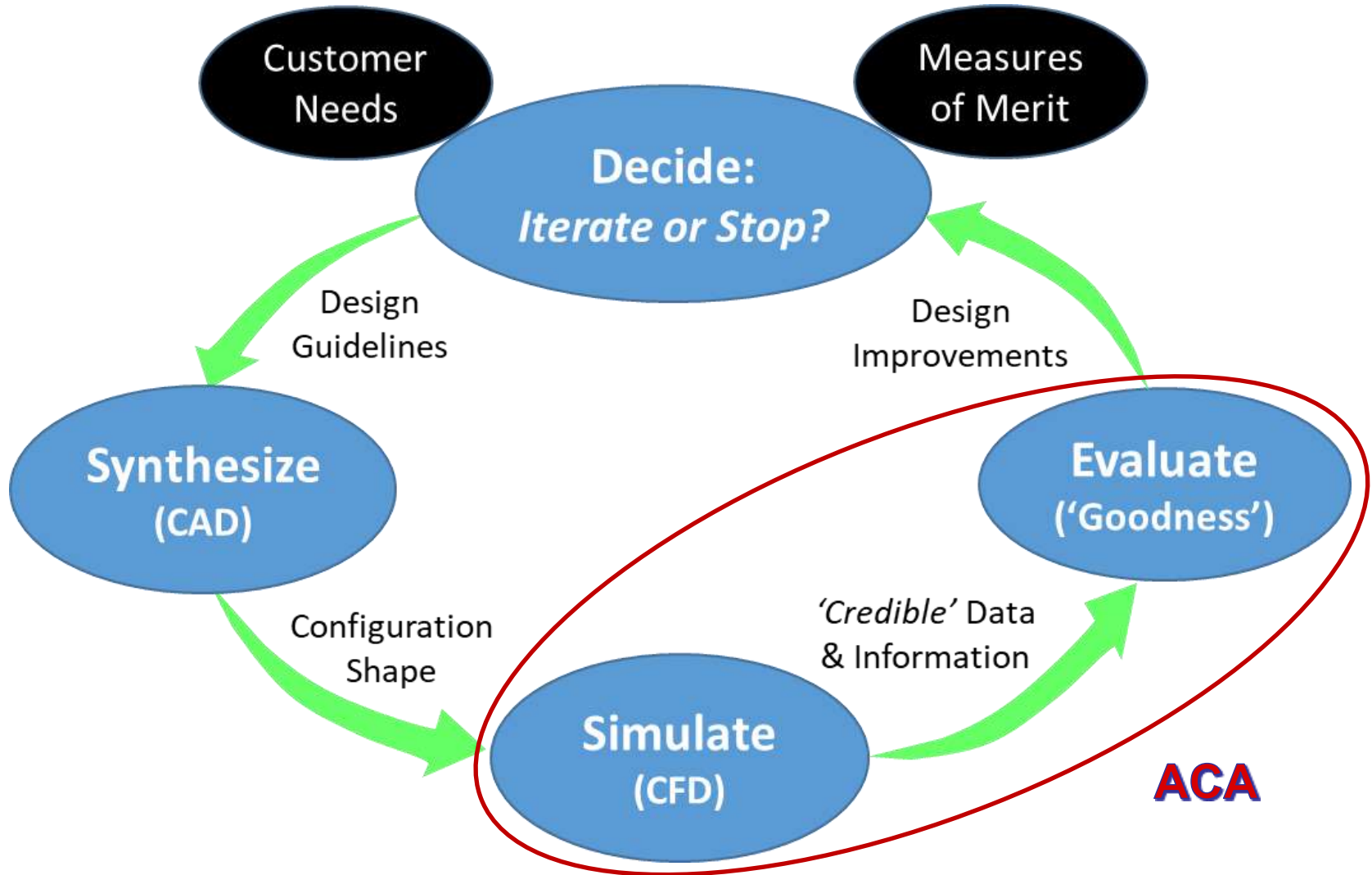

Fully Effective ACA

Ability to deliver credible solutions* of aerodynamic problems using CFD—on time and on budget—to support engineering design

**how faithfully the solutions replicate reality*

Miranda, in *AIAA 82-0018*, defined Effectiveness as a product of two factors:

$$\text{Effectiveness} = \text{Quality} \times \text{Acceptance}$$

“Quality” (*how well the results replicate reality*)

Credibility of the results of the comp aero simulation of flows about arbitrarily shaped configurations

“Acceptance” (*on time, on budget delivery of results*)

Ease of use; short turnaround time (elapsed time from go-ahead to delivery); low cost (labor hours & H/W+S/W costs)

Fully Effective ACA Requires Simultaneous Maximization of Both Quality and Acceptance Factors

Pervasive Role of ACA in Engineering Design Drives the Pursuit of Fully Effective ACA

Luis R. Miranda



Manager
Computational Aerodynamics
Lockheed-California Co.

Section 1.

Overarching Takeaways

***CFD Produces Data, ACA Produces Solutions.
Don't Confuse Data with Solutions!***

CFD is to ACA as Airplane is to Air Transportation!

Section 1: Key Takeaways

- **ACA is an *engineering* discipline, CFD is an *applied science* discipline (being a sub-discipline of fluid dynamics)**
 - ACA is purpose-driven application of CFD...purpose is to deliver credible solutions of engineering problems on time and on budget
 - **Fully Effective ACA** delivers solutions that replicate reality, on time and on budget

- **ACA uses CFD to create value for the customer**

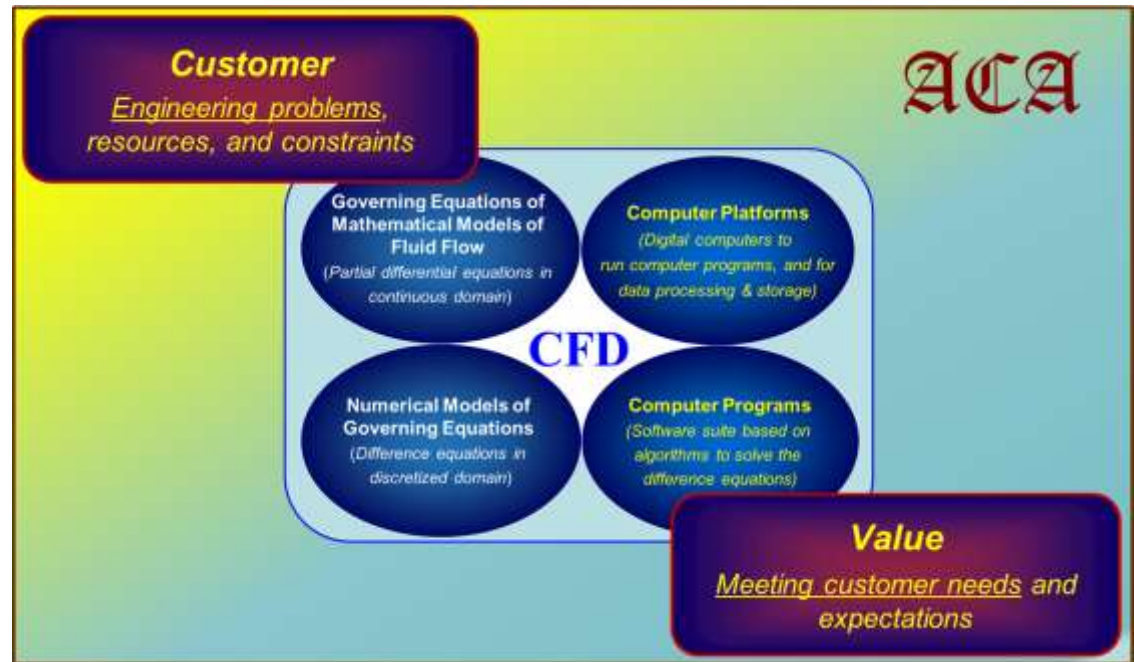

- **ACA is no longer a luxury, but a necessity, to support engineering design of all types of objects that move through air**

BIBLIOGRAPHY

SECTION 1

1. Introduction and Scope

- 1.1 Roach, P.J., *Computational Fluid Dynamics*, Hermosa Publishers, 1976, and *Fundamental of Computational Fluid Dynamics*, 1998.
- 1.2 Anderson, D.A., Tannehill, J.C., and Pletcher, R.H., *Computational Fluid Mechanics and Heat Transfer*, McGraw-Hill, 1984.
- 1.3 Lomax, H., Pulliam, T.H., and Zingg, D. W., *Fundamentals of Computational Fluid Dynamics*, Springer, 2001.
- 1.4 Jameson, A., *Computational Aerodynamics*, Cambridge University Press, 2022.
- 1.5 *Applied Computational Aerodynamics*, edited by P.A. Henne, Progress in Astronautics and Aeronautics, Vol. 125, AIAA, Washington, D.C., 1990
- 1.6 Löhner, R., *Applied CFD Techniques*, Wiley, 2008.
- 1.7 Cummings, R.M., Mason, W.H., Morton, S.A., McDaniel, D.R., *Applied Computational Aerodynamics*, Cambridge Univ. Press, 2015
- 1.8 Rodriguez, S., *Applied Computational Fluid Dynamics and Turbulence Modeling*, Springer, 2019.
- 1.9 https://en.wikipedia.org/wiki/Andr%C3%A9_Gide
- 1.10 Theodore von Kármán with Lee Edson, *The Wind and Beyond: Theodore von Kármán Pioneer in Aviation and Pathfinder in Space*, Little, Brown and Company, 1967.
- 1.11 Mason, W.H., “Applied Computational Aerodynamics Case Studies,” AIAA 92-2661, *10th Applied Aerodynamics Conference*, Palo Alto, CA, June 22-24, 1992. <https://doi.org/10.2514/6.1992-2661>
- 1.12 Johnston, C.E., Youngren, H.H., and Sikora, J.S., “Engineering Applications of an Advanced Low-Order Panel Method,” SAE Paper 851793, October 1985.
- 1.13 Bangert, L.H., Johnston, C.E., and Schoop, M.J., “CFD Applications in F-22 Design,” AIAA Paper 93-3055, *24th Fluid Dynamics Conference*, Orlando, Florida, July 6-9, 1993.
- 1.14 Goble, B.D., King, S., Terry, J., and Schoop, M.J., “Inlet Hammershock Analysis Using a 3-D Unsteady Euler/Navier-Stokes Code,” AIAA 96-2547, *32nd AIAA, ASME, SAE and ASEE, Joint Propulsion Conference and Exhibit*, Lake Buena Vista, Florida, July 1-3 1996.
- 1.15 Goble, B.D., and Hooker, J.R., “Validation of an Unstructured Grid Euler/ Navier-Stokes Code on a Full Aircraft with Propellers,” AIAA Paper 2001-1003, *39th Aerospace Sciences Meeting*, Reno, Nevada, January 8-11, 2001.
- 1.16 Hooker, J.R., “Aerodynamic Development of a Refueling Pod for Tanker Aircraft,” AIAA 2002-2805, *20th Applied Aerodynamics Conference*, St. Louis, Missouri, June 24-26, 2002. <https://doi.org/10.2514/6.2002-2805>
- 1.17 Hooker, J.R., Hoyle, D.L., and Bevis, D.N., “The Application of CFD for the Aerodynamic Development of the C-5M Galaxy,” AIAA 2006-0856, *44th Aerospace Sciences Meeting*, Reno, Nevada, 9-12 January 2006.

BIBLIOGRAPHY

SECTION 1 (contd.)

1. Introduction and Scope

- 1.18 Raj, P., "CFD at a Crossroads: An Industry Perspective," *Frontiers of Computational Fluid Dynamics*, World Scientific Publishing Co., 1998, pp. 429-445, Caughey, D.A. and Hafez, M.A. (Editors). (Presented at Thirty Years of CFD and Transonic Flow Symposium to honor Prof. Earl Murman on his 55th Birthday, Everett, WA, June 1997.)
- 1.19 Raj, P., "Aircraft Design in the 21st Century: Implications for Design Methods (Invited)," AIAA 98-2895, *29th AIAA Fluid Dynamics Conference*, Albuquerque, NM, June 15-18, 1998.
- 1.20 Raj, P., "Computational Uncertainty: Achilles' Heel of Simulation Based Aircraft Design (Invited)," NATO/RTO Air Vehicle Technology (AVT) Symposium on Computational Uncertainty in Military Vehicle Design, Athens, Greece, December 3-6, 2007.
- 1.21 Wick, A.T., Hooker, J.R., Barberie, F.J., and Zeune, C.H., "Powered Lift CFD Predictions of a Transonic Cruising STOL Military Transport," AIAA 2013-1098, *51st Aerospace Sciences Meeting*, Grapevine, TX, 7-10 January 2013. <https://doi.org/10.2514/6.2013-1098>
- 1.22 Hooker, J.R., and Wick, A., "Design of the Hybrid Wing Body for Fuel Efficient Air Mobility Operations," AIAA 2014-1285, *52nd AIAA Aerospace Science Meeting*, National Harbor, MD, 13-17 January 2014. <https://doi.org/10.2514/6.2014-1285>
- 1.23 Miranda, L. R., "A perspective of Computational Aerodynamics from the Viewpoint of Airplane Design Applications", AIAA Paper 82-0018, *20th Aerospace Sciences Meeting*, Orlando, Florida, January 11-14, 1982 (later published in *AIAA Journal of Aircraft* <https://doi.org/10.2514/3.44974>)

	Slide #
Preface	3
1. Introduction and Scope	11
2. Genesis of Fluid Dynamics (<i>Antiquity to 1750</i>)	52
3. Fluid Dynamics as a Mathematical Science (<i>1750–1900</i>)	77
4. Emergence of Computational Fluid Dynamics (<i>1900–1950</i>)	98
5. Evolution of Applied Computational Aerodynamics (<i>1950–2000</i>)	124
5.1 <i>Infancy through Adolescence (1950–1980)</i>	127
Level I: Linear Potential Methods (LPMs)	127
Level II: Nonlinear Potential Methods (NPMs)	138
5.2 <i>Pursuit of Effectiveness (1980–2000)</i>	163
Level III: Euler Methods	167
Level IV: Reynolds-Averaged Navier-Stokes (RANS) Methods	210
6. ACA Effectiveness: Status and Prospects (<i>2000 and Beyond</i>)	229
6.1 <i>Assessment of Effectiveness (2000–2020)</i>	231
6.2 <i>Prospects for Fully Effective ACA (Beyond 2020)</i>	261
7. Closing Remarks	286
Appendix A	295

Why Look Back?

***Study the past, if you would
define the future.***

— Confucius (551 – 479 BC)

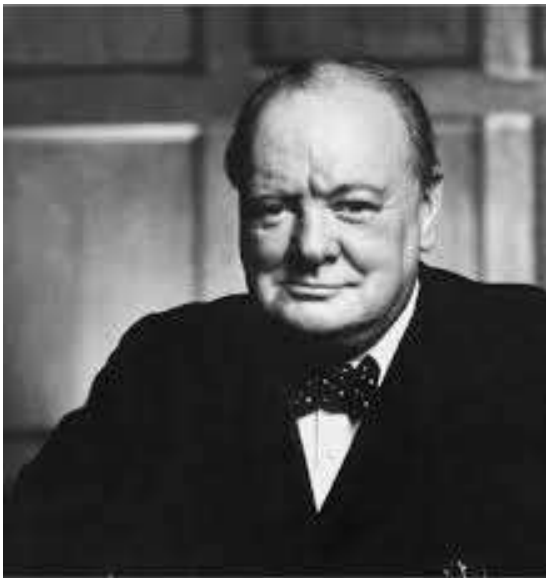

***The further backward you look,
the further forward you can see.***

— Churchill (1874 – 1965)

The Old Testament (1200 – 165 BC)

Proverbs 30:18-19

“There be three things which are too wonderful for me, yea four which I know not.”

“The way of an eagle in the air, the way of a serpent upon a rock, the way of a ship in the midst of the sea, and the way of a man with a maid.”



Two of the Three Things Involve Flow of Fluids and They Remain “Too Wonderful” Today!

Early Days of Civilization

Two Crucial Needs

1. **Water Distribution to villages and cities for farming and household use**--canals and conduits were built to transport water



*Eupalinos underground aqueduct
(ca 6th century BC)*



*Aqua Anio Vetus Roman
aqueduct (ca 272 BC)*



*Aqueduct of Segovia
(ca 100 AD)*

2. **Maritime Transport to supply essential goods**--river boats and seafaring ships powered by sails or manual propulsion were built

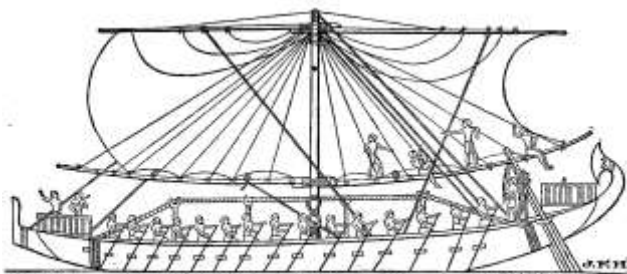

*Egyptian ship on the Red Sea, about 1250 B.C. [From Torr's "Ancient Ships."]
Mr. Langton Cole calls attention to the rope truss in this illustration, stiffening the beam of the ship. No other such use of the truss is known until the days of Modern roasting.*

Ancient Egyptian ship (ca 1250 BC)



Vikings landing in Britain (ca 449 AD)

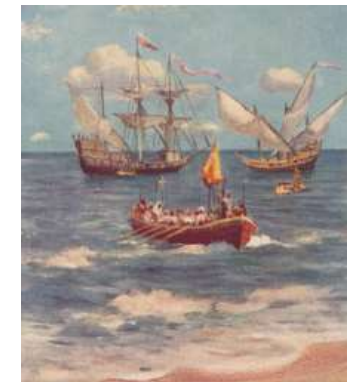

*Vasco da Gama at
Calicut, India (ca 1498 AD)*

Early Days of Civilization

Two Sets of “Grand Challenge” Problems

1. Problems of Resistance

- Motivating societal needs:
 - navigation (ships)
 - fluid-driven machines (waterwheels and mills)
 - ballistics (projectiles)
- ***How does a fluid current affect a body in its path?***



2. Problems of Discharge

- Motivating societal needs:
 - water distribution
 - jet reaction machines
- ***How do fluids discharge themselves from reservoirs and through tubes or pipes?***



Impetus for the Genesis of “Fluid Dynamics”

Addressing “Grand Challenge” Problems

Two Branches of Investigations Emerged

Hydraulics

Artisan Activity Based on Empirical Knowledge to Devise Practical Solutions to Problems of Fluids in Motion or at Rest

Flourished for Countless Millennia

Hydrodynamics

Scientific Activity Based on Laws of Nature to Develop Fundamental Understanding and Knowledge of Fluid Flows to Solve Problems

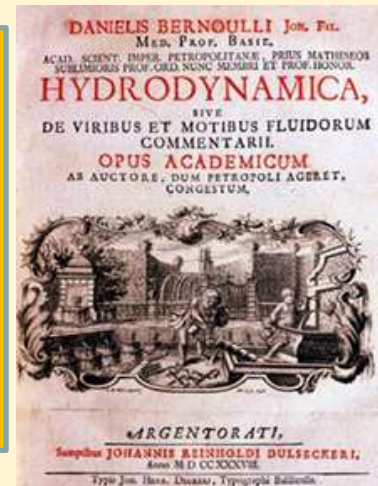

Daniel Bernoulli



8 Feb 1700 – 17 Mar 1782

Formally Emerged in 1738!

Hydrodynamics:

Emerged as the Preferred Approach for Solving Fluid Flow Problems

Key Foundational Theories, Principles, and Laws of Fluid (Aero/Hydro) Dynamics:

Antiquity to 1750

Concept of Continuum

Medium Theory

Aristotle



384–322 B.C.

Scientific Observation of Flows

Leonardo da Vinci



15 April 1452 – 2 May 1519

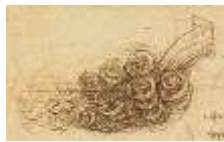

Pascal's Law

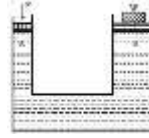

Blaise Pascal



19 Jun 1623 – 19 Aug 1662

Laws of Mechanics of Motion

Isaac Newton



25 Dec 1642 – 20 Mar 1727

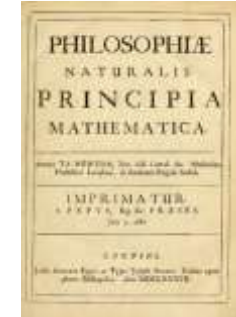

**Book 2:
The Motion of Bodies
(in Resisting Mediums)**

"Internal Pressure" in Moving Fluids

Johann Bernoulli



6 Aug 1667 – 1 Jan 1748

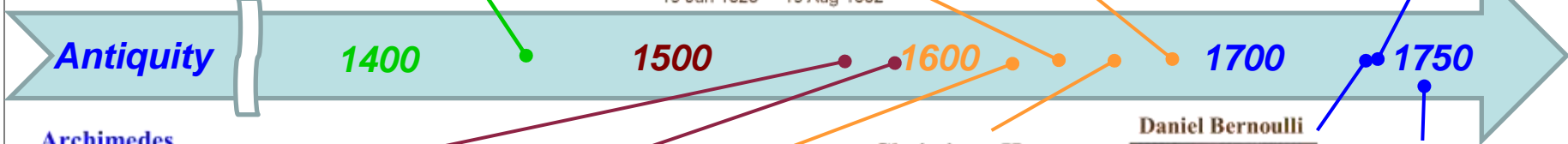

Antiquity

1400

1500

1600

1700

1750

Archimedes

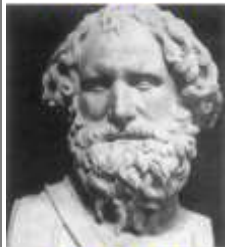

287–212 B.C.

Archimedes' Principle

Hydrostatics

Simon Stevin



1548 – 1620

Stevin's Principle

Galileo Galilei



15 Feb 1564 – 8 Jan 1642

Scientific Method

Evangelista Torricelli



15 Oct 1608 – 25 Oct 1647

Torricelli's Law

$$v \propto \sqrt{h}$$

Christiaan Huygens



14 Apr 1629 – 8 Jul 1695

Huygens' Law

$$R \propto V^2$$

Daniel Bernoulli



8 Feb 1700 – 17 Mar 1782

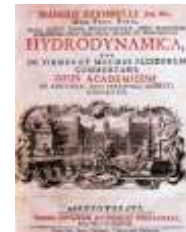

Jean le Rond d'Alembert



16 Nov 1717 – 29 Oct 1783

'Theoria Resistancia' d'Alembert's Paradox

In the Beginning... *The Greek Thought*

Aristotle

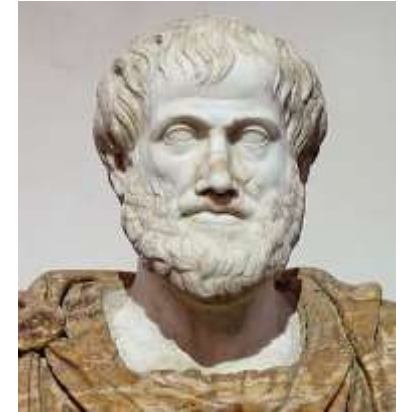

Greek Philosopher
384–322 B.C.

- **Four Basic Elements Theory**

- Universe consists of four basic elements: *fire, air, water, earth*
- Protagonists included Pythagoras (~580-500 BC), Empedocles (490-430 BC), Plato (427-347 BC), and Aristotle (384-322 BC)
 - Their theories significantly departed from mythology
- Aristotle--a pure theorist--probably had the most influence on the growth of scientific knowledge in general, and fluid mechanics in particular, that lasted nearly 2,000 years

- **Nature Abhors Vacuum**

- Space around us must be occupied by one element or another
- **Vacuums**—*the absence of any and everything*—were simply an impossibility.

- **Concept of Continuum**

“The **continuous** may be defined as that which is divisible into parts which are themselves **divisible to infinity**, as a body which is divisible in all ways. Magnitude divisible in one direction is a line, in three directions a body. Being divisible in three directions, a body is divisible in all directions. And magnitudes which are divisible in this fashion are continuous.”

- **Theory of Motion**

- In a void, a body at rest will remain at rest, and a body in motion will continue to have the same motion unless some obstacle comes into collision
- Everything that is in motion must be moved by something. **A body in motion is being driven by fluid closing in behind.** [An arrow creates a vacuum in its wake, into which air rushes, pushing it from behind.] *Paradoxically, air also resists motion!*

“The Birth of Hydrostatics”

Basic Principles

- *Proposition 3:* Of solids those which, size for size, are of equal weight with a fluid will, if let down into the fluid, be immersed so that they do not project above the surface but do not sink lower.
- *Proposition 4:* A solid lighter than a fluid will, if immersed in it, not be completely submerged, but part of it will project above the surface.
- *Proposition 5:* Any solid lighter than a fluid will, if placed in the fluid, be so far immersed that the weight of the solid will be equal to the weight of the fluid displaced.
- *Proposition 7:* A solid heavier than a fluid will, if placed in it, descend to the bottom of the fluid, and the solid will, when weighed in the fluid, be lighter than its true weight by the weight of the fluid displaced.
- *Postulates:* Fluids cannot have internal empty spaces, i.e., they *must be continuous*. And if fluid parts are continuous and uniformly distributed, then that which is the least compressed is driven along by that which is more compressed. In a fluid “each part is always pressed by the whole weight of the column perpendicularly above it.”

Archimedes' Principle (or Law)

When a solid body is immersed in a fluid, it is pressed vertically upwards by the fluid with a force equal to the weight of the fluid displaced, the force is known as buoyancy.

Archimedes

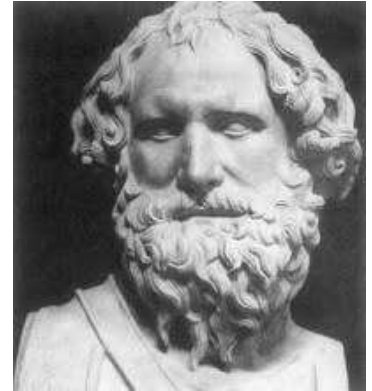

Greek Mathematician
287–212 B.C.

Archimedes' Screw a water elevating machine

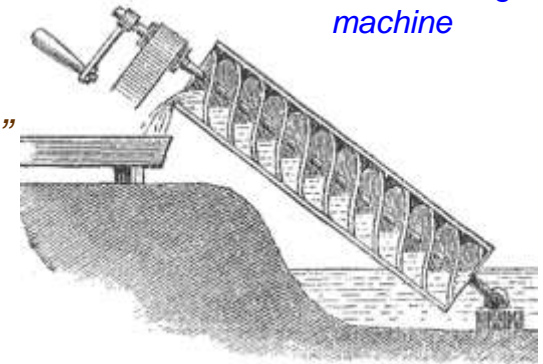

[Arguably] No Major Advancements for Next 17 Centuries!

Direct Study of Nature: *The Renaissance* (15th Century)

- **The *First Scientific Observer of Flows***



Leonardo da Vinci



Italian Artist, Engineer, Scientist
15 Apr 1452 – 2 May 1519

- **Principle of Continuity**

“By so much as you will increase the river in breadth, by so much you will diminish the speed of its course.” (i.e., $area \times speed = constant$)

- **Principle of Relative Motion**

The air’s action is the same whether the bird is at rest in a moving airstream—hovering at a cliff edge in a strong breeze—or is moving through still air.

- **Principle of Circulation**

“The helical or rather rotary motion of every liquid is so much the swifter as it is nearer to the center of its revolution...the motion of the [solid] circular wheel is so much the slower as it’s nearer the center...[for water] we have the same motion, through speed and length, in each whole revolution of the water, just the same in the circumference of the greatest circle as in the least...”

- **Air Resistance is Directly Proportional to Speed**

Scientific Method: *The Renaissance* (16th Century)

- **Emergence of Scientific Method**

Galileo adds Experimentation and Quantification to Da Vinci's Observation for studying nature

- **Tenets of Scientific Method**

- **OBSERVE:** Observe phenomena
- **HYPOTHESIZE:** Formulate *hypotheses* via induction
- **TEST:** Experimentally test deductions from hypotheses
- **REFINE:** Use findings to *refine* or *eliminate hypotheses*

- **Galilean Principle of Inertia**

A body in motion would remain in motion unless a force caused it to come to rest. It contradicted the widely accepted Aristotelian theory of motion

Galileo Galilei



Italian Philosopher, Astronomer and “Geometer” (Mathematician)
15 Feb 1564 – 8 Jan 1642

“Philosophy is written in this grand book, which stands continually open before our eyes (I say the 'Universe'), but cannot be understood without first learning to comprehend the language...it is written in mathematical language, and its characters are triangles, circles and other geometric figures...”

-- Galileo Galilei, The Assayer, Oct. 1623

Advancement of Hydrostatics (16th Century)

Simon Stevin



Flemish Mathematician
1548 – 1620



- **Principle of Solidification**

In any fluid at rest, if any portion be replaced by a rigid solid, the forces exerted by the remainder will not be altered

- **Pressure on the Side of a Vessel**

Used limit arguments to prove that water in the rectangular box exerts a force at the center of mass of the vertical wall ACDE equal to that of the weight of the water volume ACHDE

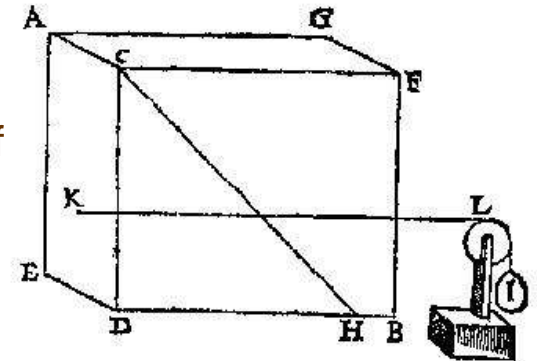

- **Genesis of 'Hydrostatic Paradox'**

The **hydrostatic pressure** at the bottom of a container filled with a liquid depends, linearly, only on the height of the liquid column, and not on the particular shape (and thus on the volume) of the container

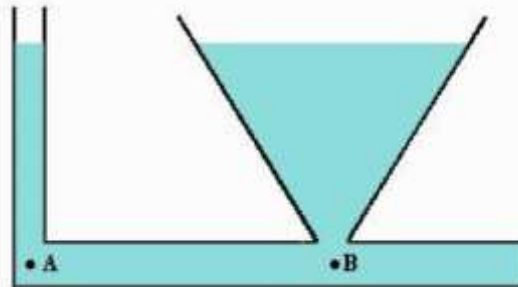

“Any column of water, however small, may be made to support any weight, however large.”

First Notable Contributions Since Archimedes!

Advancement of Fluid Statics

(17th Century)

- **Barometric Pressure**

- **Torricelli (1630)** invents mercury barometer; gives partial explanation of its operation
- **Pascal (1647)** repeats Torricelli's experiment, and further studies atmosphere
 - Variation of atmospheric pressure cause liquid level to change from day to day
 - Atmospheric pressure reduces with altitude
 - *"Nature does not abhor vacuum"* -- contradicting prevailing Aristotelian wisdom
- Pascal proves that pressure at any point in a fluid is the same in all directions

- **Pascal's Law (1647-48)**

- A change in pressure at any point in an enclosed fluid *at rest* is transmitted undiminished to all points in the fluid
- Resolves Hydrostatic Paradox, and enables development of hydraulic devices

"In order to show that a hypothesis is evident, it does not suffice that all the phenomena follow from it; instead, if it leads to something contrary to a single one of the phenomena, that suffices to establish its falsity."

-- Blaise Pascal

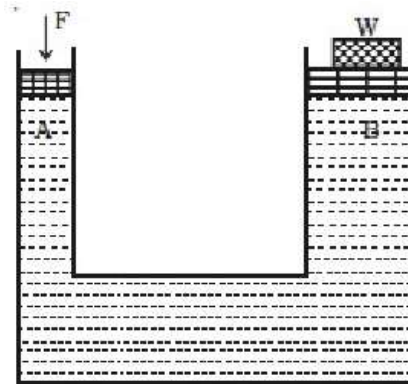
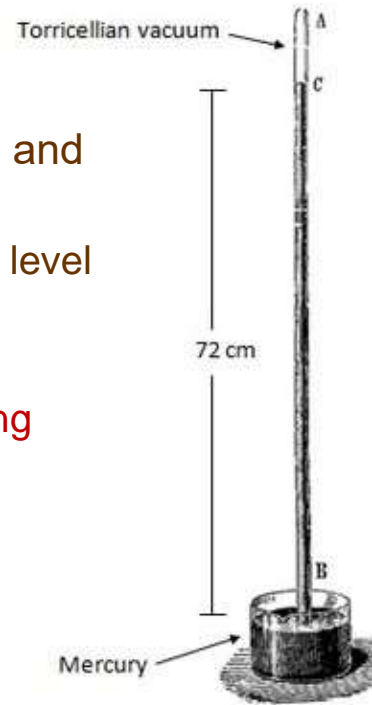

Evangelista Torricelli



Italian Physicist

15 Oct 1608 – 25 Oct 1647

Blaise Pascal



French Philosopher

19 Jun 1623 – 19 Aug 1662

Study of Discharge Problem (17th Century)

Efflux of Water from Vessels

Torricelli's Law (1644)

Efflux velocity is proportional to the square root of the depth: $v \propto \sqrt{h}$

Water jet from a small hole rises almost to the same height as the water level in the tank.

The upwards velocity at B is the same as the downwards velocity at E.

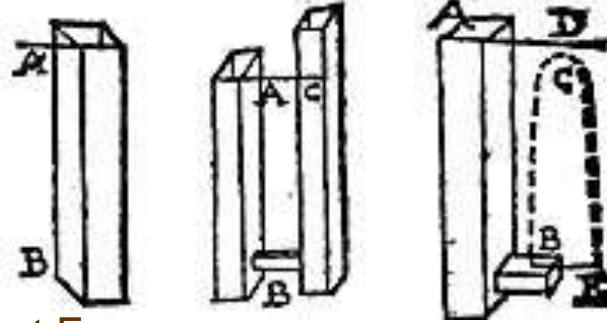

Applies Galilean Principle for falling motion of bodies to the efflux of liquids from vessels!

Huygens Experiments (1668)

Confirmed Torricelli's Law!

However, disparate results obtained based on the geometry of the apparatus, such as, form of the vessel, type of spout, relative location of orifice to the surface of the vessel.

Modified Law: $v \propto k\sqrt{h}$

Proportionality constant, k, adjusted to match measurements!

Evangelista Torricelli



Italian Physicist
15 Oct 1608 – 25 Oct 1647

Christiaan Huygens



Dutch Scientist
14 Apr 1629 – 8 Jul 1695

Study of Resistance Problem (17th Century)

Resistance of Fluid on Bodies

Huygens Law (1669)

Resistance is proportional to the square of the fluid velocity
(when the velocity doubles, the resistance quadruples)

- Deduced from experiments with projectiles.

Corrects prevailing thought that resistance is proportional to the fluid velocity (when the velocity doubles, the resistance doubles)

Experimentally measures resistance of

(i) a wooden cube being dragged through a water channel



(ii) fully submerged bodies moving through air



Mariotte's Principle (1673)

Resistance is proportional to the square of the fluid velocity
(when the velocity doubles, the resistance quadruples)

- Deduced from experiments with moving fluid impacting on a flat surface.

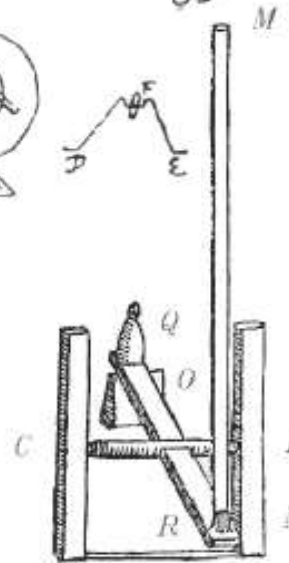

Christiaan Huygens



Dutch Scientist
14 Apr 1629 – 8 Jul 1695

Edme Mariotte



French Physicist
1620 – 12 May 1684

Insights into the Nature of Fluids (17th Century)

- **Boyle's Hypothesis (1661)**

Matter consists of little particles in motion; every phenomenon is the result of *collisions of particles in motion*.

- **Two types of Fluids: Liquids (water) & Gases (air)**

Liquids form a free surface not created by their container;
Gases occupy the entire volume of the container.

- **Boyle's Law (1662)**

"The product of pressure (P) and volume (V) is a constant for a given mass of confined gas as long as the temperature is constant."

$$P \propto \frac{1}{V}$$

Liquids may be regarded as incompressible.

- **Charles' Law (1780—a century later)**

"The volume (V) of a gas increases linearly with the absolute temperature (T) of the gas as long as pressure is constant."

$$V \propto T$$

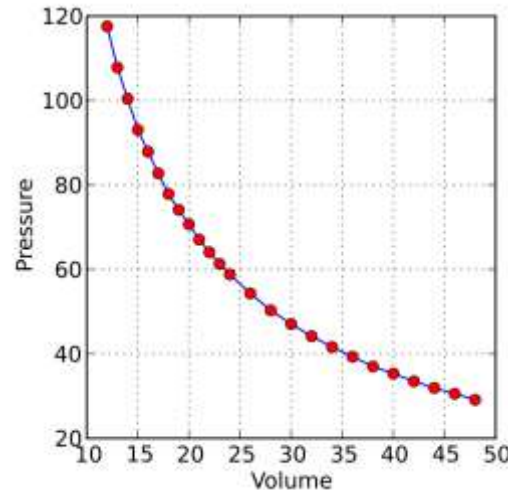

Robert Boyle



Anglo-Irish Philosopher
25 Jan 1627 – 31 Dec 1691

Jacques Charles



French Physicist
12 Nov 1746 – 7 Apr 1823

Basic Laws of Mechanics of Motion (17th Century)

- **Mathematical Principles of Natural Philosophy (July 5, 1687)**

"...the basic problem of [natural] philosophy seems to be to discover the forces of nature from the phenomena of motions and then to demonstrate the other phenomena from these forces; and to this end the general propositions in the first and second Books are directed."

- **Book I: Of the Motion of Bodies**

- Deals with rigid bodies (point masses)
- **First complete, rational, theoretical derivation of all motions from a few axioms and laws**

- **Book II: Of the Motion of Bodies (in Resisting Mediums)**

- Deals with two types of fluids:
 - 'Rare Medium'—collection of disconnected, *non-interacting* perfectly spherical elastic particles which exchange momentum when they collide with a body
 - 'Continued Medium'—a continuous chain of particles
- *Several different hypotheses added to the few in Book I*
- **Includes some small fudges and implausible constructions as well!**

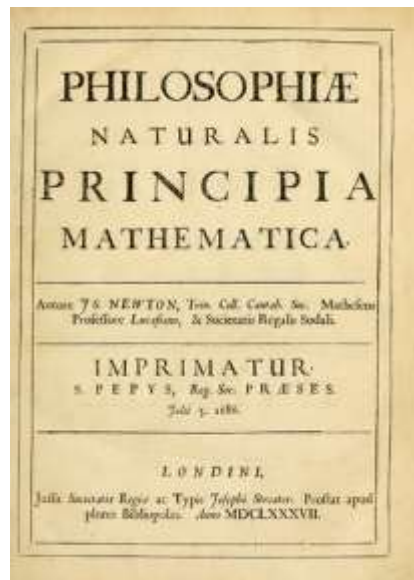

"the greatest production of the human mind."

Lagrange (1736-1813)

Isaac Newton



English Physicist &
Mathematician

25 Dec 1642 – 20 Mar 1727

Newton's Theory of Fluid Resistance (17th Century)

- **Mathematical Principles of Natural Philosophy (July 5, 1687)**

- Book II: *Of the Motions of Bodies (in Resisting Mediums)*

- **Resistance of bodies moving through a fluid (Proposition 33)**

$$D \propto \rho S V^2$$

- *First theoretical derivation of the drag (resistance) force of a body!*

- **Fluid dynamic force on a flat plate**

$$R = \rho V^2 S \sin^2 \alpha$$

$$\frac{L}{D} = \cot \alpha$$

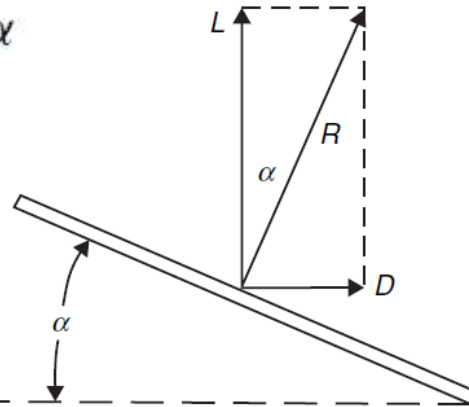

- *Formula is based on Proposition 34...but the formula is not found in Newton's work!*
- *'Rare Medium' fluid model used for this formula*

- **Internal resistance within a flow created by its own velocity gradients**

"The resistance arising from the want of lubricity in the parts of a fluid, is, proportional to the velocity with which the parts of the fluid are separated from each other."

- *Provides the well-known linear relationship of shear stress and rate of strain for 'Newtonian' fluids*

$$\tau \propto dV/dn$$

- *Explains creation of vortex motion about a rotating cylinder in a tank of water*

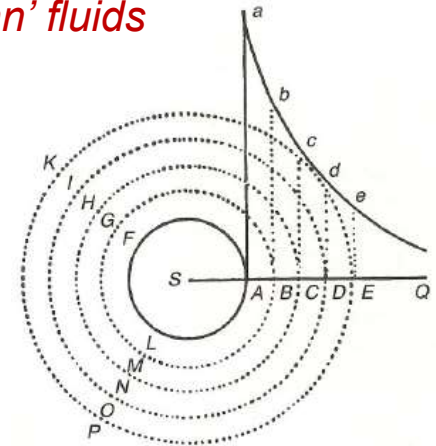

Birth of “Hydrodynamics” (18th Century)

Daniel Bernoulli



Swiss Mathematician
8 Feb 1700 – 17 Mar 1782

1738

- Daniel Bernoulli successfully derived ‘hydraulic-static’ pressure exerted by a moving fluid on the wall of its container--going beyond Stevin’s and Pascal’s Laws of hydrostatic pressure
- Employed elements of calculus for analysis using continuity and von Leibniz ‘vis viva’ (‘live force’) or kinetic energy principles; *verified predictions using experiments!*
- Devised parallel-slice hypothesis for flow through ducts
- Analyzed efflux through small opening at the bottom of a vessel that showed compliance with Torricelli’s Law

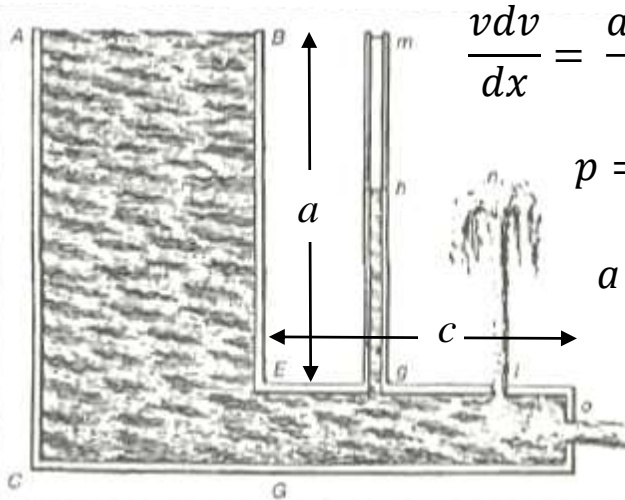
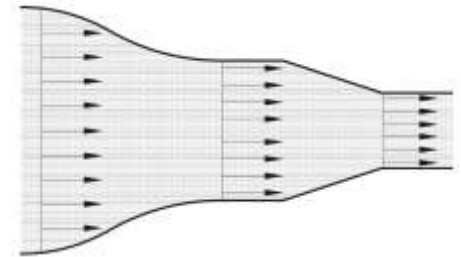

$$\frac{v dv}{dx} = \frac{a - vv}{2c}$$

$$p = \frac{a - v^2}{2c}$$

$a = \text{‘head’}$

Bernoulli Principle
Pressure decreases as velocity increases in a flowing fluid.

[Well known] Bernoulli’s Equation is Not in the Book!

J. Bernoulli's *Hydraulica* (18th Century)

Johann Bernoulli



Swiss Mathematician
6 Aug 1667 – 1 Jan 1748

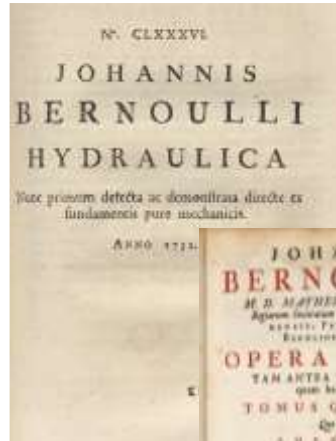

1742



- Analyzed fluid flow through a duct with abrupt change in area using Newton's Laws—instead of 'vis viva' theory used by his son, Daniel

- Inserted whirlpools to convert jump into continuous area variation

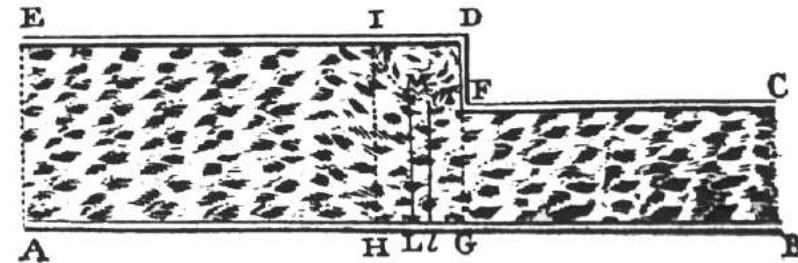

- Developed equations of motion of accelerating flow by applying Newton's Second Law to parallel slices of fluid
- Introduced the new concept of convective derivative to account for acceleration due to broadening or narrowing of area—in addition to that due to instantaneous change in velocity
- Generalized Daniel Bernoulli's principle for pressure in non-steady flow

A New Concept of Internal Pressure in Moving Fluids

“The force that acts on the side of a channel through which a liquid flows...is nothing but the force that originates in the force of compression through which contiguous parts of the fluid act on one another.”

Theory of Resistance: A Grand Milestone! (18th Century)

16 May 1748

Berlin Academy Prize Announced
for Determination of Drag

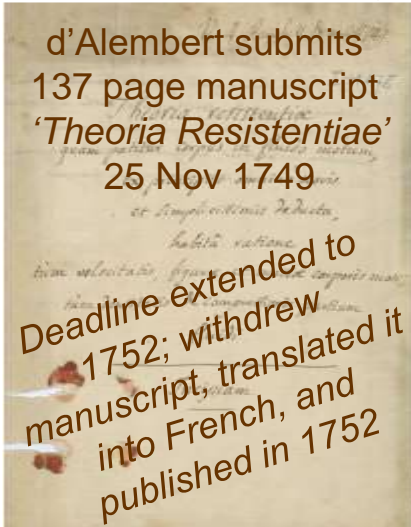

Jean le Rond d'Alembert



French Mathematician
16 Nov 1717 – 29 Oct 1783

- Flow of inviscid fluid about a body is a field of continuous variation in velocity
- Determine the fluid field, then integrate local pressures to find force exerted on the body
- *Introduces streamlines, and front and aft stagnation points and zones, for 2-D and axisymmetric bodies*
- Develops two equations relating partial derivatives of axial and lateral velocity components to force components for steady flow
- Used his dynamical principle and equilibrium principle to derive hydrodynamical equations for steady, inviscid, incompressible, 2-D and axisymmetric flows
- Uses complex variable transformation and developments in power series in attempts to determine velocity field that is uniform at infinity and tangent to the body along its surface—but *unable to solve the equations*
- Instead applies his knowledge of Bernoulli's work to estimate drag
- Conclusion: Due to symmetrical fluid field, a symmetrical body "...would suffer no force from the fluid, which is contrary to experience."

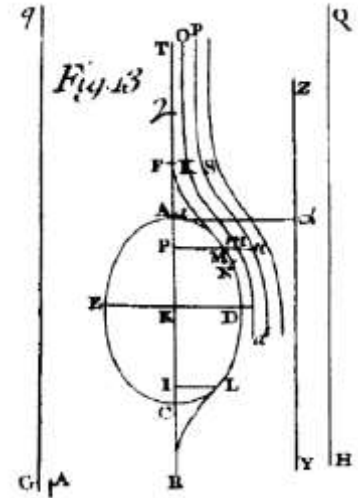

"...it seems to me that the theory, developed in all possible rigor, gives, at least in several cases, a strictly vanishing resistance, a singular paradox which I leave to future geometers* to elucidate."

Conclusion Gave Birth to d'Alembert's Paradox

**i.e. mathematicians - the two terms were used interchangeably at that time*

d'Alembert's great strides in the use of mathematics to solve fluid dynamic problems were harbinger of the direction of the field of fluid dynamics for the next 150 years and beyond!

Section 2.

Overarching Takeaways

“Everything in Nature Goes by Law, and Not by Luck.”

Ralph Waldo Emerson

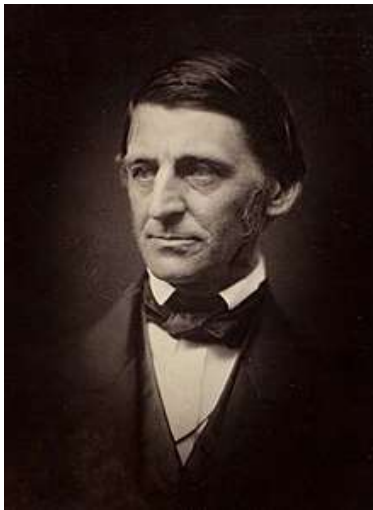

25 May 1803 – 27 April 1882

Laws of Nature Serve as Universal Constraints on the Flow of Fluids



Source: AIAA-1982-0315

Section 2: Key Takeaways

- **Early Days of Civilization**
 - **Two sets of “Grand Challenge” Problems**
 1. Problems of **Resistance** (ships, water wheels, projectiles,...)
 2. Problems of **Discharge** (water distribution, jet reaction machines,...)
 - **Two Branches of Investigations to Address Grand Challenge Problems**
 1. **Hydraulics** (artisan activity based on empirical knowledge)
 2. **Hydrodynamics** (scientific activity based on fundamental laws of nature)
- **Key Foundational Ideas for Fluid Dynamics (*Antiquity to 1750*)**
 - **384-322 BC: Aristotle—*concept of continuum***
 - **287-212 BC: Archimedes—*principles of hydrostatics***
 - **1452-1519: Leonardo da Vinci—*principles of continuity and relative motion***
 - **1586: Stevin—*hydrostatic pressure depends only on the height of the fluid column***
 - **1644: Torricelli—*efflux velocity is proportional to the square root of depth***
 - **1669: Huygens—*resistance is proportional to square of velocity***
 - **1687: Newton—*Laws of Mechanics and theory of fluid resistance***
 - **1738: D. Bernoulli—*pressure decreases as velocity increases***
 - **1742: J. Bernoulli—*concept of internal pressure in moving fluids***
 - **1749: d’Alembert—*symmetrical body would suffer no fluid force--a Paradox!***

BIBLIOGRAPHY

SECTION 2

2. Genesis of Fluid Dynamics (*Antiquity to 1750*)

- 2.1 Rouse, H., Highlights in the History of Hydraulics, Books at Iowa, no.38, 1983, pp. 3-17. <https://doi.org/10.17077/0006-7474.1448>
- 2.2 Nakayama, Y. and Boucher, R.F., “Introduction to Fluid Mechanics,” Butterworth-Heinemann, 2000.
- 2.3 Calero, J.S., The Genesis of Fluid Mechanics 1640-1780, Studies in History and Philosophy of Science, Vol. 22, Springer, 2008.
- 2.4 Anderson, J.D., Jr., “Brief History of the Early Development of Theoretical and Experimental Fluid Dynamics,” Encyclopedia of Aerospace Engineering, John Wiley & Sons, Ltd., 2010, Blockley and Shyy (editors).
<http://e.roohi.profcms.um.ac.ir/imagesm/1019/stories/PDFs/Aerodynamics/brief%20history.pdf>
- 2.5 Tokaty, G.A., A History and Philosophy of Fluid Mechanics, Dover Publications, 1971.
- 2.6 <https://www.google.com/search?client=firefox-b-1-d&q=four+propositions+of+archimedes+for+hydrostatics>
- 2.7 Yves van Gennip, “The Limits of Simon Stevin,” CASA Seminar, 25 January 2006.
https://www.win.tue.nl/casa/meetings/seminar/previous/_abstract060125_files/Simon_Stevin.pdf
- 2.8 Bernoulli, D., “Hydrodynamica, sive de viribus et motibus fluidorum commentarii,” 1738. <http://dx.doi.org/10.3931/e-rara-3911>
- 2.9 Grimberg, G., Pauls, W., and Frisch, U., “Genesis of d’Alembert’s paradox and analytical elaboration of the drag problem,” Physica D 237, Elsevier, 2008, pp 1878-1886, <http://gidropraktikum.narod.ru/grimberg-pauls-frisch.pdf>
- 2.10 M. d’Alembert, “Essai d’une nouvelle théorie de la résistance des fluides,” 1752
<https://gallica.bnf.fr/ark:/12148/bpt6k1520055w/f19.item>

	Slide #
Preface	3
1. Introduction and Scope	11
2. Genesis of Fluid Dynamics (<i>Antiquity to 1750</i>)	52
3. Fluid Dynamics as a Mathematical Science (<i>1750–1900</i>)	77
4. Emergence of Computational Fluid Dynamics (<i>1900–1950</i>)	98
5. Evolution of Applied Computational Aerodynamics (<i>1950–2000</i>)	124
5.1 <i>Infancy through Adolescence (1950–1980)</i>	127
Level I: Linear Potential Methods (LPMs)	127
Level II: Nonlinear Potential Methods (NPMs)	138
5.2 <i>Pursuit of Effectiveness (1980–2000)</i>	163
Level III: Euler Methods	167
Level IV: Reynolds-Averaged Navier-Stokes (RANS) Methods	210
6. ACA Effectiveness: Status and Prospects (<i>2000 and Beyond</i>)	229
6.1 <i>Assessment of Effectiveness (2000–2020)</i>	231
6.2 <i>Prospects for Fully Effective ACA (Beyond 2020)</i>	261
7. Closing Remarks	286
Appendix A	295

Fluid Dynamics as a Mathematical Science

(1750 – 1900)

The Euler Equations (1755-57)

Leonhard Euler



15 Apr 1707 – 8 Sep 1783

$$\begin{aligned}
 P & - \frac{1}{q} \left(\frac{dp}{dx} \right) = \left(\frac{du}{dt} \right) + u \left(\frac{du}{dx} \right) + v \left(\frac{du}{dy} \right) + w \left(\frac{du}{dz} \right) \\
 Q & - \frac{1}{q} \left(\frac{dp}{dy} \right) = \left(\frac{dv}{dt} \right) + u \left(\frac{dv}{dx} \right) + v \left(\frac{dv}{dy} \right) + w \left(\frac{dv}{dz} \right) \\
 R & - \frac{1}{q} \left(\frac{dp}{dz} \right) = \left(\frac{dw}{dt} \right) + u \left(\frac{dw}{dx} \right) + v \left(\frac{dw}{dy} \right) + w \left(\frac{dw}{dz} \right) \\
 & \left(\frac{dq}{dt} \right) + \left(\frac{d.qu}{dx} \right) + \left(\frac{d.qv}{dy} \right) + \left(\frac{d.gw}{dz} \right)^* = 0
 \end{aligned}$$

equation of state (a relation between p , q and r)

*misprint: g should be q .

“...it is not the laws of Mechanics that we lack...but only the Analysis, which has not yet been sufficiently developed...”

“...steady direct motion in round tubes is stable or unstable according as $\rho DU_m/\mu < 1900$ or > 2000 ,...”

$$\rho \frac{d\bar{u}}{dt} = - \left\{ \frac{d}{dx} (\bar{p}_{xx} + \rho \bar{u}\bar{u} + \rho \bar{u}'\bar{u}') + \frac{d}{dy} (\bar{p}_{yx} + \rho \bar{u}\bar{v} + \rho \bar{u}'\bar{v}') + \frac{d}{dz} (\bar{p}_{zx} + \rho \bar{u}\bar{w} + \rho \bar{u}'\bar{w}') \right\}$$

&c.
&c.

“...equations of mean-mean-motion...”

Osborne Reynolds



23 Aug 1842 – 21 Feb 1912

The Reynolds-Averaged Navier-Stokes (RANS) Equations (1895)

1750

1800

1850

1900

Joseph-Louis Lagrange



25 Jan 1736 – 10 Apr 1813

steady incompressible flow

$$\frac{\rho v^2}{2} + p = \text{const}$$

‘Bernoulli’s Equation’

George Stokes



13 Aug 1819 – 1 Feb 1903

The Navier-Stokes Equations (1849)

$$\rho \left(\frac{Du}{Dt} - X \right) + \frac{dp}{dx} - \mu \left(\frac{d^2u}{dx^2} + \frac{d^2u}{dy^2} + \frac{d^2u}{dz^2} \right) - \frac{\mu}{3} \frac{d}{dx} \left(\frac{du}{dx} + \frac{dv}{dy} + \frac{dw}{dz} \right) = 0,$$

$$\frac{d\rho}{dt} + \frac{d\rho u}{dx} + \frac{d\rho v}{dy} + \frac{d\rho w}{dz} = 0,$$

equation connecting p and ρ ,

...conditions which must be satisfied at the surface of a solid in contact with the fluid...are unknown.

Foundations of Mathematical Fluid Dynamics (18th Century)

‘PRINCIPES GÉNÉRAUX DU MOUVEMENT DES FLUIDES’

Académie Royale des Sciences et des Belles-Lettres de Berlin

Presented 4 September 1755 [printed in 1757]

- **Three equations of motion derived from the first axioms of mechanics using ‘infinitesimal fluid particle’**

$$\begin{aligned}
 P & - \frac{1}{q} \left(\frac{dp}{dx} \right) = \left(\frac{du}{dt} \right) + u \left(\frac{du}{dx} \right) + v \left(\frac{du}{dy} \right) + w \left(\frac{du}{dz} \right) \\
 Q & - \frac{1}{q} \left(\frac{dp}{dy} \right) = \left(\frac{dv}{dt} \right) + u \left(\frac{dv}{dx} \right) + v \left(\frac{dv}{dy} \right) + w \left(\frac{dv}{dz} \right) \\
 R & - \frac{1}{q} \left(\frac{dp}{dz} \right) = \left(\frac{dw}{dt} \right) + u \left(\frac{dw}{dx} \right) + v \left(\frac{dw}{dy} \right) + w \left(\frac{dw}{dz} \right)
 \end{aligned}$$

P, Q, R: accelerative forces due to gravity

p, q, u, v, w : pressure, density, and three components of velocity

() : partial derivatives

- **One continuity equation** $\left(\frac{dq}{dt} \right) + \left(\frac{d.qu}{dx} \right) + \left(\frac{d.qv}{dy} \right) + \left(\frac{d.gw}{dz} \right)^* = 0$
- **One equation of state**, i.e., a relation between p, q and r
 - Here r expresses that other property [temperature] which, in addition to q , influences p in a compressible fluid (nature of fluid is assumed to be known.)



Leonhard Euler



Swiss Mathematician

15 Apr 1707 – 8 Sep 1783

“...five equations encompassing the entire theory of the motion of fluids.” – Euler

Tokaty on Euler's Equations

G.A. Tokaty, Soviet Scientist, Zhukovsky Academy (defected to Britain in 1947)

Emeritus Professor, Aeronautics and Space Technology, The City University, London

“...geometry is a branch of mathematics which treats the shape and size of things; while Fluidmechanics is the science of motion (and equilibrium) of bodies of deformable (and variable) shapes, under the action of forces...some theorems and **axioms of geometry do not meet the philosophical and physical needs of mechanics generally, and of Fluidmechanics in particular**... For example, a point is usually defined as an element of geometry which has position but no extension; a line as a path traced out by a point in motion...But motion and matter cannot be divorced. A **point** that has no extension lacks volume and, consequently, mass, therefore **is nothing**; and **nothing can have neither path nor momentum, or motion.**”

Grigori Tokaty



13 Oct 1909 – 23 Nov 2003

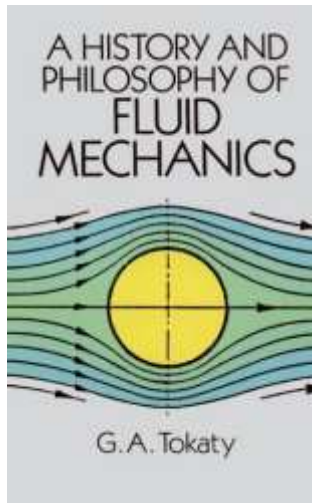

[Euler imagined] a fluid particle as an infinitesimal body, small enough to be treated mathematically as a point, but large enough to possess such physical properties as volume, mass, density, inertia, etc.

“Euler was, perhaps, the first to overcome this fundamental contradiction, by means of the introduction of his historic ‘fluid particle’, thus giving Fluidmechanics a powerful instrument of physical and mathematical analysis.”

“The Blood, the Flesh, and the Bones of Fluid Mechanics”

Euler's Observations on His Five Equations of Motion of Fluids

'PRINCIPES GÉNÉRAUX DU MOUVEMENT DES FLUIDES' 4 Sep 1755 [printed in 1757]

- “The equations contain four variables x , y , z and t which are absolutely independent of each other... the other variables u , v , w , p and q must be certain functions of the former.”
- “...before we can begin to solve the equations, we need to know what sort of functions of x , y , z and t must be used to express the values of u , v , w , p and q ...”
- “However, since very little work has yet been done... *we cannot hope to obtain a complete solution of our equations until the limits of Analysis have been extended much further.*”
- “The best approach would therefore be to ponder well on the particular solutions of our differential equation that we are in a position to obtain...”
- “...if the three velocities are known, we can determine the trajectory described by each element of the fluid in motion.” [streamlines]
- “If the shape of the vessel in which the fluid moves is given, the fluid particles that touch the surface of the vessel must necessarily follow its direction,...” [surface boundary condition]

“...it is not the laws of Mechanics that we lack...but only the Analysis, which has not yet been sufficiently developed for this purpose. It is therefore clearly apparent what discoveries we still need to make in this branch of Science before we can arrive at a more perfect Theory of the motion of fluids.”

Analytical Solutions of Euler Equations (18th Century)

Lagrange (1778) matured ‘total differential’ notion into a powerful tool and applied it to Euler equations to conclude: **the equations could be solved only for two particular cases**

Joseph-Louis Lagrange



Franco-Italian Mathematician
25 Jan 1736 – 10 Apr 1813

1. Unsteady Compressible Flow

By introducing velocity potential, $\varphi(x, y, z, t)$, and gravitational potential, $\Phi(x, y, z)$, Lagrange reduces Euler equations to a single total differential equation whose integral is

$$\frac{v^2}{2} + \int \frac{dp}{\rho} + \frac{\partial \varphi}{\partial t} - d\Phi = C(t)$$

2. Steady Compressible Flow

Solution is the equation for case 1 (above) subject to $\partial \varphi / \partial t = 0$, and $C(t)$ just a constant.

- For **steady, incompressible flows**, the solution of the Euler equations is

$$\frac{v^2}{2} + \frac{p}{\rho} - \Phi = C = \text{const}$$

The third term is typically negligibly small compared to the first two. and we get the now widely known ‘**Bernoulli’s Equation**’ $\frac{\rho v^2}{2} + p = \text{const}$

Lagrange’s Concept of Velocity Potential Revolutionized Evolution of Fluid Dynamics—It Remains a Vital Part to This Day

Mathematical Underpinnings of Potential Flow Theory (18th Century)

- **Scalar Potential**

- A fundamental mathematical concept that simplifies the study of quantities whose definition requires both magnitude and direction (vectors) over a given field or domain
- Scalar potential is the scalar value associated with every point in a field. Beware that all vector fields do not have scalar potential!
- In physics, it describes the situation where the difference in the potential energies of an object at two locations depends only on its location, not upon the path taken; examples include gravitational potential and electrostatic potential
- In an orthogonal coordinate system, partial derivatives give the magnitude of the vector

- **Potential Theory**

- **Laplace (1783)** applied the language of calculus to show that a scalar potential, $V(x,y,z)$, always satisfies the differential equation

$$\frac{\partial^2 V}{\partial x^2} + \frac{\partial^2 V}{\partial y^2} + \frac{\partial^2 V}{\partial z^2} = 0$$

- Mathematicians developed many methods to solve this linear, second-order PDE subject to prescribed boundary conditions

Pierre-Simon Laplace



French Scholar
23 Mar 1749 – 5 Mar 1827

“All the Effects of Nature are only the Mathematical Consequences of a Small Number of Immutable Laws.” — Laplace

Green's Theorem

A Key Theorem for Mathematical Analysis of Potential Flows (19th Century)

AN ESSAY ON THE APPLICATION OF MATHEMATICAL ANALYSIS TO THE THEORIES OF ELECTRICITY AND MAGNETISM,

Originally published as a book in Nottingham, 1828.*

Before proceeding to make known some relations which exist between the density of the electric fluid at the surfaces of bodies, and the corresponding values of the potential functions within and without those surfaces, the electric fluid being confined to them alone, we shall in the first place, lay down a general theorem which will afterwards be very useful to us. This theorem may be thus enunciated:

George Green



British Mathematician
14 Jul 1793 – 31 May 1841

Let U and V be two continuous functions of the rectangular co-ordinates x, y, z , whose differential co-efficients do not become infinite at any point within a solid body of any form whatever; then will

$$\int dx dy dz U \delta V + \int d\sigma U \left(\frac{dV}{dw} \right) = \int dx dy dz V \delta U + \int d\sigma V \left(\frac{dU}{dw} \right);$$

the triple integrals extending over the whole interior of the body, and those relative to $d\sigma$, over its surface, of which $d\sigma$ represents an element: dw being an infinitely small line perpendicular to the surface, and measured from this surface towards the interior of the body.

Note that:
$$\delta V = \frac{d^2 V}{dx^2} + \frac{d^2 V}{dy^2} + \frac{d^2 V}{dz^2}$$

*Reprinted in three parts in Journal für die reine und angewandte Mathematik Vol. 39, 1 (1850) p. 73–89; Vol. 44, 4 (1852) p. 356–74; and Vol. 47, 3 (1854) p. 161–221. From there transcribed by Ralf Stephan (ralf@ark.in-berlin.de)

Advances in Fluid Dynamics Driven by Mathematical Techniques

(19th Century)

Augustin-Louis Cauchy



French Mathematician
21 Aug 1789 – 23 May 1857

- **Cauchy (1841) mathematically proved that motion of a fluid particle consists of three parts**
 - a. Translational motion at velocity $V (v_x, v_y, v_z)$
 - b. Rigid Body Rotational motion with angular velocity $\omega (\omega_x, \omega_y, \omega_z)$
 - c. Deformational motion characterized by function $\Phi (x, y, z)$ with nine numbers representing rate of normal and shear strains
- **When ω is zero, the flow is *irrotational* consisting of translational and deformational motions only; the vorticity of the fluid is zero**
- **For 2D, steady, incompressible, irrotational flow, Cauchy showed that the stream function, $\psi(x,y)$, too satisfied Laplace's equation, much like the velocity potential, $\phi(x,y)$**
 - $\phi(x,y)$ and $\psi(x,y)$, are associated through the Cauchy-Riemann conditions, and are called conjugate functions
 - Fluid flows can be represented by equipotential ($\phi = \text{const.}$) lines and streamlines ($\psi = \text{const.}$) that are orthogonal
 - Associated theory of *analytic functions of complex variables* offers many interesting and important solutions

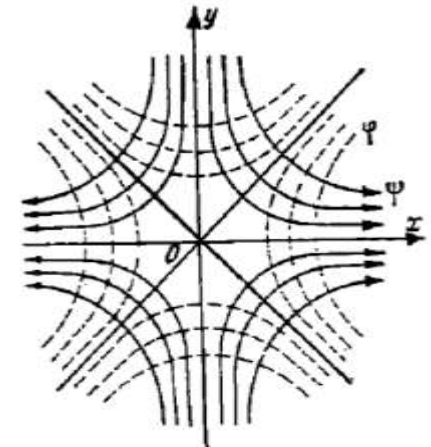

Ideal Fluid Dynamics

Application of Green's Theorem to Irrotational Flows (19th Century)

Extensions of theoretical and mathematical advances in electrostatics and magnetism to ideal fluid dynamics followed naturally due to the analogy of velocity potential, ϕ , with electrostatic potential, and magnetic potential

(Lamb: *Treatise on the Mathematical Theory of the Motion of Fluids*, 1879; *Hydrodynamics*, 1895, 6th ed. 1932)

- If we denote the two continuous, single-valued functions, U and V , in the Green's theorem by ϕ and ϕ' respectively, satisfying $\nabla^2\phi = 0$ and $\nabla^2\phi' = 0$ throughout a given region bounded by the surface S , then

$$\iint \phi \frac{\partial \phi'}{\partial n} dS = \iint \phi' \frac{\partial \phi}{\partial n} dS.$$

- Taking ϕ to be the velocity potential and choosing $\phi' = 1/r$, the velocity potential ϕ_P at any point P in the space occupied by the fluid may be written as:

$$\phi_P = -\frac{1}{4\pi} \iint \frac{1}{r} \frac{\partial \phi}{\partial n} dS + \frac{1}{4\pi} \iint \phi \frac{\partial}{\partial n} \left(\frac{1}{r} \right) dS. \quad \text{Only surface integrals!}$$

1st term is surface distribution of simple sources with density of $-\partial\phi/\partial n$; and 2nd term is surface distribution of double sources (doublets) with axes normal to the surface and density ϕ . *This is only one of infinite distributions that give the same value of ϕ*

- The irrotational flow of fluids in a simply-connected region is determined when either ϕ or inward normal velocity $-\partial\phi/\partial n$ is prescribed at all points of the boundary, or ϕ over part of the boundary and $-\partial\phi/\partial n$ over the remainder
- Lamb (*Ch. III, 6th ed.*) shows that representations of ϕ_P in terms of simple sources *alone*, or of double sources *alone*, are unique

Horace Lamb



British Mathematician
27 Nov 1849 – 4 Dec 1934

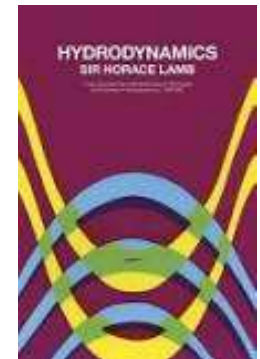

Dover edition, 1945
(republication of 1932 6th edition)

Ideal Fluid Dynamics

Key Theorems for Flows with Vorticity

(19th Century)

- **Helmholtz postulated three theorems (1858) based on his proof of indestructability and uncreatability of vorticity in inviscid, barotropic* fluid subjected to conservative body forces only**
 1. The strength of a vortex filament is constant along its length.
 2. A vortex filament cannot end in a fluid; it must extend to the boundaries of the fluid or form a closed path.
 3. In the absence of rotational external forces, a fluid that is initially irrotational remains irrotational.

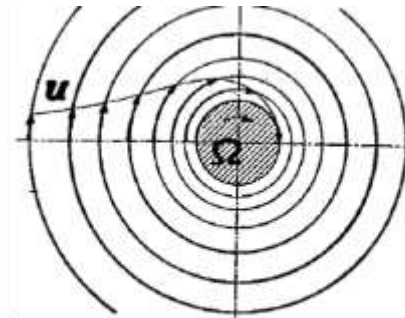

Induced velocity field of a vortex filament

[Cauchy had mathematically proven (1841) that the motion of a fluid particle consisted of translational, rigid body rotational, and deformational motions; when rotational motion is not zero, the flow contains a string of rotating elements or vortex lines.]

- **Kelvin circulation theorem (1867)**
 - Circulation (Γ) around a closed curve moving with the fluid remains constant with time, that is, $D\Gamma/Dt = 0$

*density is a function of only pressure

Hermann von Helmholtz



German Scientist & Philosopher
31 Aug 1821 – 8 Sep 1894

**William Thomson
1st Baron Kelvin**

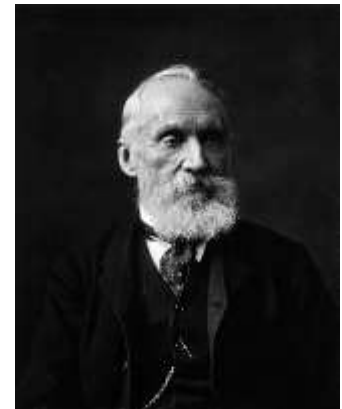

British Mathematical Physicist
26 Jun 1824 – 17 Dec 1907

Modified Euler Equations

(19th Century)

Claude Louis Marie
Henri Navier



French Engineer

10 Feb 1785 – 21 Aug 1836

Mémoire sur les lois du Mouvement des Fluides (1823)

Mémoires de l'Académie Royale des Sciences de l'Institut de France

- Contains modified Euler equations for incompressible flow based on a different model of fluid to account for **attractive and repulsive intermolecular forces**

$$\begin{aligned}
 \text{P} \quad -\frac{dp}{dx} &= \rho \left(\frac{du}{dt} + u \frac{du}{dx} + v \frac{du}{dy} + w \frac{du}{dz} \right) - \epsilon \left(\frac{d^2 u}{dx^2} + \frac{d^2 u}{dy^2} + \frac{d^2 u}{dz^2} \right) \\
 \text{Q} \quad -\frac{dp}{dy} &= \rho \left(\frac{dv}{dt} + u \frac{dv}{dx} + v \frac{dv}{dy} + w \frac{dv}{dz} \right) - \epsilon \left(\frac{d^2 v}{dx^2} + \frac{d^2 v}{dy^2} + \frac{d^2 v}{dz^2} \right) \\
 \text{R} \quad -\frac{dp}{dz} &= \rho \left(\frac{dw}{dt} + u \frac{dw}{dx} + v \frac{dw}{dy} + w \frac{dw}{dz} \right) - \epsilon \left(\frac{d^2 w}{dx^2} + \frac{d^2 w}{dy^2} + \frac{d^2 w}{dz^2} \right)
 \end{aligned}$$

- ϵ is a function of spacing between molecules
- **Slip boundary condition:** e.g., for a wall perpendicular to z-axis

$$\mathbf{E}u + \epsilon \frac{du}{dz} = 0, \quad \mathbf{E}v + \epsilon \frac{dv}{dz} = 0$$

- ϵ , a function of nature of fluid and wall, is to be determined experimentally

Navier's Modified Euler Equations Resemble Those for Viscous Fluids Derived by Stokes Based on His Theory of Internal Friction

Theory of Viscous Fluids in Motion (19th Century)

On the Theories of the Internal Friction of Fluids in Motion and of the Equilibrium and Motion of Elastic Solids, Transactions of Cambridge Philosophical Society, Vol. 8, pp 287-319, 1849 (Read April 14, 1845)

George Stokes

“The equations of Fluid Motion commonly employed depend upon *the fundamental hypothesis that the mutual action of two adjacent elements of the fluid is normal to the surface which separates them.*”

“But there is a whole class of motions of which the common theory takes no cognizance whatever, namely, those which depend on the tangential action called into play by the sliding of one portion of a fluid along another, or of a fluid along the surface of a solid, or of a different fluid, that action in fact which performs the same part with fluids that friction does with solids.”

“Again, suppose that water is flowing down a straight aqueduct of uniform slope, what will be the discharge corresponding to a given slope, and a given form of the bed? Of what magnitude must an aqueduct be, in order to supply a given place with a given quantity of water? Of what form must it be, in order to ensure a given supply of water with the least expense of materials in the construction? *These, and similar questions are wholly out of the reach of the common theory of Fluid Motion, since they entirely depend on the laws of the transmission of that tangential action which in it is wholly neglected.*”

XVII. *On the Theories of the Internal Friction of Fluids in Motion, and of the Equilibrium and Motion of Elastic Solids.* By G. G. STOKES, M.A., Fellow of Pembroke College.

[Read April 14, 1845.]

THE equations of Fluid Motion commonly employed depend upon the fundamental hypothesis that the mutual action of two adjacent elements of the fluid is normal to the surface which separates them. From this assumption the equality of pressure in all directions is easily deduced, and thus the equations of motion are formed according to D'Alembert's principle. This appears to me the most natural light in which to view the subject; for the two principles of the absence of tangential action, and of the equality of pressure in all directions ought not to be assumed as independent hypotheses, or as successive ones, inasmuch as the latter is a necessary consequence of the former*. The equations of motion are very complicated, but yet they admit of solution in some instances, especially in the case of small velocities. The results of the theory agree in the whole with observation, so far as the time of oscillation is concerned. But there is a whole class of motions of which the common theory takes no cognizance whatever, namely, those which depend on the tangential action called into play by the sliding of one portion of a fluid along another, or of a fluid along the surface of a solid, or of a different fluid, that action in fact which performs the same part with fluids that friction does with solids.

Thus, when a ball performs oscillation in an infinitely extended fluid, the common theory gives the arc of oscillation constant. Observation however shows that it diminishes very rapidly in the case of a liquid, and diminishes, but less rapidly, in the case of an elastic fluid. It has indeed been attempted to explain this diminution by supposing a friction to act on the ball, and this hypothesis may be approximately true, but the imperfection of the theory is shown from the circumstance that no account is taken of the equal and opposite friction of the ball on the fluid.

Again, suppose that water is flowing down a straight aqueduct of uniform slope, what will be the discharge corresponding to a given slope, and a given form of the bed? Of what magnitude must an aqueduct be, in order to supply a given place with a given quantity of water? Of what form must it be, in order to ensure a given supply of water with the least expense of materials in the construction? These, and similar questions are wholly out of the reach of the common theory of Fluid Motion, since they entirely depend on the laws of the transmission of that tangential action which in it is wholly neglected. It has, according to the common theory, the water ought to flow on with uniformly accelerated velocity, for even the opposition of a certain friction against the bed could be of no avail, for such friction could not be transmitted through the mass. The general importance of such questions as those above mentioned has made them the object of numerous experiments, from which empirical formulae have been ascertained. But such formulae, although fulfilling well enough the purpose for which they were

* This may be easily shown by the consideration of a succession of two fluids, see Art. 4.



British Mathematician & Physicist
13 Aug 1819 – 1 Feb 1903

The Navier-Stokes Equations

(19th Century)

George Stokes



British Mathematician & Physicist

13 Aug 1819 – 1 Feb 1903

*On the Theories of the Internal Friction of Fluids in Motion
and of the Equilibrium and Motion of Elastic Solids*

Transactions of Cambridge Philosophical Society, Vol. 8,
pp 287-319, 1849 (Read April 14, 1845)

$$\frac{d\rho}{dt} + \frac{d\rho u}{dx} + \frac{d\rho v}{dy} + \frac{d\rho w}{dz} = 0, \dots\dots\dots (11)$$

$$\rho \left(\frac{Du}{Dt} - X \right) + \frac{dp}{dx} - \mu \left(\frac{d^2 u}{dx^2} + \frac{d^2 u}{dy^2} + \frac{d^2 u}{dz^2} \right) - \frac{\mu}{3} \frac{d}{dx} \left(\frac{du}{dx} + \frac{dv}{dy} + \frac{dw}{dz} \right) = 0, \&c\dots\dots(12)$$

equation connecting p and ρ ,

μ is assumed to be constant, not dependent on *pressure* or *temperature*

Boundary condition for fluid in contact with a solid

“The most interesting questions connected with this subject require for their solution a knowledge of the conditions which must be satisfied at the surface of a solid in contact with the fluid, which, *except perhaps in case of very small motions, are unknown.*”

Distinct Types of Viscous Flows (19th Century)

An Experimental Investigation of the Circumstances which determine whether the Motion of Water shall be Direct or Sinuous, and of the Law of Resistance in Parallel Channels

Philosophical Transactions of the Royal Society of London, 174, 1883, pp 935-982 (Read March 15, 1883)

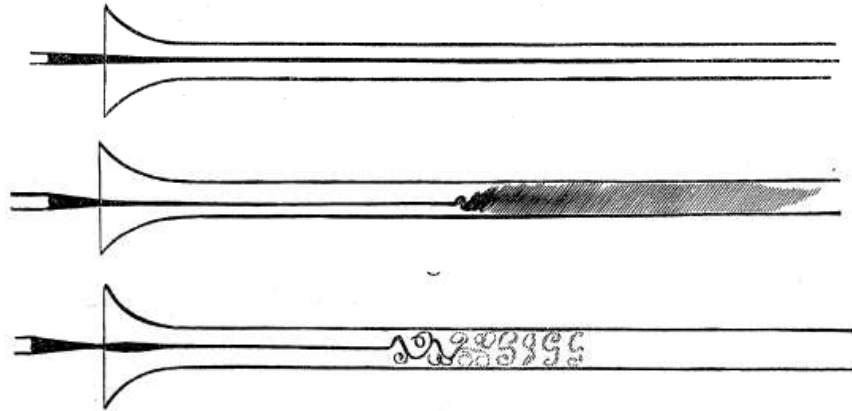

Direct

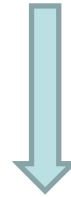

With
increasing
 $\rho c U_m / \mu$

Sinuous

Osborne Reynolds



British Engineer and Physicist
23 Aug 1842 – 21 Feb 1912



“...the broad fact of there being a critical value for the velocity [U_m] at which the steady motion becomes unstable, which critical value is proportional to $\mu/\rho c$ where c is the diameter of the pipe and μ/ρ the viscosity by the density, is abundantly established.”

Governing Equations of Turbulent Flows (19th Century)

On the Dynamical Theory of Incompressible Viscous Fluids and the Determination of the Criterion, Philosophical Transactions of the Royal Society of London (A), 186, 1895, pp 123-164 (Read May 24, 1894)

- **Experimental criterion:** "...steady direct motion in round tubes is stable or unstable according as $\rho DU_m/\mu < 1900$ or > 2000 ... a criterion for the possible maintenance of sinuous or eddy motion."
- **Theoretical development:** introduced concepts of 'mean-mean-motion' and 'relative-mean-motion'

$$\bar{u} = \frac{\sum(\rho u)}{\sum \rho}, \text{ \&c., \&c.} \dots \dots \dots (4)$$

$$\rho u = \rho \bar{u} + \rho u' \dots \dots \dots (5)$$

Osborne Reynolds

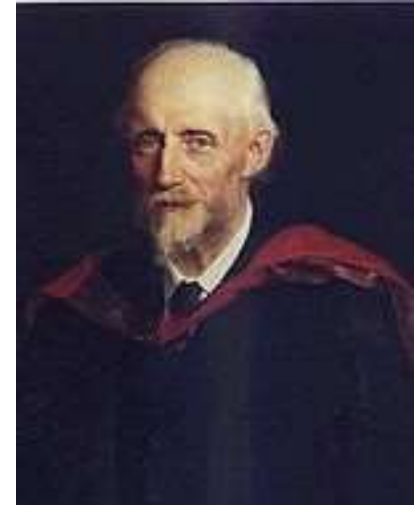

British Engineer and Physicist
23 Aug 1842 – 21 Feb 1912

- **Equations of mean-mean-motion of turbulent flows**

$$\rho \frac{d\bar{u}}{dt} = - \left\{ \frac{d}{dx} (\overline{p_{xx}} + \rho \overline{uv} + \rho \overline{u'u'}) + \frac{d}{dy} (\overline{p_{yx}} + \rho \overline{uv} + \rho \overline{u'v'}) + \frac{d}{dz} (\overline{p_{zx}} + \rho \overline{uw} + \rho \overline{u'w'}) \right\} \dots (15),$$

&c. = &c. &c. &c.

&c. = &c. &c. &c.

Reynolds stresses

The Reynolds-Averaged Navier-Stokes (RANS) Equations!

Reynolds' 1895 Paper with RANS Equations

A Transformative Achievement!

- **Reynolds' Motivation for the 1895 Paper**
 - Response to Lord Rayleigh's review comment on Reynolds' landmark 1883 paper: *'In several places the author refers to theoretical investigation whose nature is not sufficiently indicated.'*
 - In the 1895 paper, Reynolds offers proof of the existence of the criterion for the values of $K = \rho D U_m / \mu$ when direct motion changes to sinuous
- **Expert Reviewer Comments on the Paper**
 - **Sir George Stokes:** *'...the author...himself considers it [paper] as of much importance. I confess I am not prepared to endorse that opinion myself, but neither can I say that it may not be true.'*
 - **Sir Horace Lamb:** *'...the paper should be published in the Transactions as containing the views of its author on a subject which he has to a great extent created, although much of it is obscure.'*
- **The “Closure Problem” needs to be solved for RANS equations to be usable**
 - *“...one needs a means for determining the Reynolds stresses in terms of known or calculable quantities...Reynolds himself only obliquely touched on this.” – Launder (2015)*
- **Turbulence Modeling (determining Reynolds stresses) for RANS equations**
 - **G.I. Taylor (1915):** *“...to consider the disturbed motion of layers of air [in the atmosphere], we can take account of the eddies by introducing a coefficient of eddy viscosity...which we can express as $\frac{1}{2}\rho(\bar{w}d)$ where d is an average height through which an eddy moves before mixing with its surroundings, and \bar{w} roughly represents the average vertical velocity...where w' is positive.”*

For more than 100 years, quest for 'better' turbulence models has remained the “holy grail” of science!

“Indeed, its impact on all our lives is incalculable.” — Launder

Section 3. Overarching Takeaway

“Leonhard Euler was not a contributor to, but the founder of, Fluidmechanics, its mathematical architect, its great river.”
- Grigori Tokaty



13 Oct 1909 – 23 Nov 2003

Section 3: Key Takeaways

- **1755-57: The Euler Equations for inviscid, compressible flows**
 - Euler derived three *equations of motion* from the *first axioms of mechanics* which, combined with continuity equation and equation of state, gave “...*five equations encompassing the entire theory of the motion of fluids.*”
 - Solving the equations was hampered by “...*the Analysis, which has not yet been sufficiently developed for this purpose.*”
- **1778: Lagrange solved the Euler equations for two particular cases**
 - The case for steady, incompressible flow gave us the famous **Bernoulli's equation**
- **1849: The Navier-Stokes equations for viscous, compressible flows**
 - [boundary] conditions which must be satisfied at the surface of a solid in contact with the fluid...are unknown
- **1883: Reynolds characterized viscous flows: “...*steady direct motion in round tubes is stable or unstable according as $\rho DU_m/\mu < 1900$ or > 2000 ,...*”**
- **1895: The Reynolds-averaged Navier-Stokes (RANS) equations for viscous, compressible, turbulent flow (*mean-mean and relative-mean motions*)**
 - For RANS equations to be usable, need to address the Closure Problem: express Reynolds stresses in terms of known or calculable quantities—turbulence modeling
 - For more than 100 years, quest for ‘better’ turbulence models has been the “*holy grail*”
- **Throughout the 1800s: Impressive advances in Ideal-Fluid Dynamics [*rotational (w/ vortex filaments) and irrotational (no vorticity) flows of ideal fluids (inviscid, incompressible)*]**—fueled by advances in mathematics****

BIBLIOGRAPHY

SECTION 3

3. Fluid Dynamics as a Mathematical Science (1750–1900)

- 3.1 Darrigol, O. and Frisch, U., “From Newton’s mechanics to Euler equations,” *Physica D* 237, Elsevier, 2008, pp 1855-1869, <http://gidropraktikum.narod.ru/darrigol-frisch.pdf>
- 3.2 Euler, L., “General principles of the motion of fluids,” *Physica D* 237, Elsevier, 2008, pp 1825-1839 (adaptation by U. Frisch of an English translation by Thomas E. Burton of Euler’s ‘Principes généraux du mouvement des fluides,’ *Mémoires de l’Académie de Sciences de Berlin*, 11, 1757, pp 274-315, <http://eulerarchive.maa.org/docs/originals/E226.pdf>)
- 3.3 Euler, L., “Principles of the motion of fluids,” *Physica D* 237, Elsevier, 2008, pp 1840-1854 (an English adaptation by Walter Pauls of Euler’s ‘Pincipia motus fluidorum,’ *Novi comentarii academiae scientiarum petropolitanae*, 6, 1761, pp. 271-311, <http://eulerarchive.maa.org/docs/originals/E258.pdf>).
- 3.4 Cauchy, A., “Mémoire sur les dilatations, les condensations et les rotations produits par un changement de forme dans un systèwme de points materials,” *Oeuvres complètes d’Augustin Cauchy. Série 2, tome 12, 343-377* / publiées sous la direction scientifique de l’Académie des sciences et sous les auspices de M. le ministre de l’Instruction publique. Source gallica.bnf.fr / Université Paris Sud
- 3.5 Green, G., *An Essay on the Mathematical Analysis of the Theories of Electricity and Magnetism*, Nottingham: Printed for the author, T. Wheelhouse, 1928. <http://worrydream.com/refs/Green%20-%20The%20Application%20of%20Mathematical%20Analysis.pdf>
- 3.6 Lamb, H., *Hydrodynamics*, Cambridge University Press, 1895.
- 3.7 Helmholtz, H., “Über Integrale der hydrodynamischen Gleichungen, welche den Wirbelbewegungen entsprechen,” *Journal für die reine und angewandte Mathematik* 55 (1858): 25-55. <http://eudml.org/doc/147720>
- 3.8 Thomson, W., “On vortex motion,” *Transactions of the Royal Society of Edinburgh*, vol. xxv, 1869, pp 217-260 (Read 29th April, 1867)
- 3.9 Darve, Christine, 28 January 2003, presentation on “Memoire sur les lois du mouvement des fluides” Claude-Louise Navier, Read at the Royale Academie des Sciences, 18 Mars 1822. <https://www.scribd.com/document/363015050/Navier-Darve>
- 3.10 Stokes, G.G., “On the Theories of the Internal Friction of Fluids in Motion and of the Equilibrium and Motion of Elastic Solids,” *Transactions of Cambridge Philosophical Society*, 1849, pp 287-305. https://archive.org/details/cbarchive_39179_onthetheoriesoftheinternalfric1849/page/n1

BIBLIOGRAPHY

SECTION 3 (contd.)

- 3.11 Reynolds, O., “An Experimental Investigation of the Circumstances which determine whether the Motion of Water shall be Direct or Sinuous, and of the Law of Resistance in Parallel Channels,” Philosophical Transactions of the Royal Society of London (A), 174 (1883), pp 935-982. (Read March 15, 1883) <https://doi.org/10.1098/rstl.1883.0029>
- 3.12 Reynolds, O., “On the Dynamical Theory of Incompressible Viscous Fluids and the Determination of the Criterion,” Philosophical Transactions of the Royal Society of London (A), 186 (1895), pp 123-164. (Read May 24, 1894) <https://doi.org/10.1098/rsta.1895.0004>
- 3.13 Launder B.E., “First steps in modelling turbulence and its origins: a commentary on Reynolds (1895) ‘On the dynamical theory of incompressible viscous fluids and the determination of the criterion’,” Philosophical Transactions of the Royal Society of London (A), 373 (2015): 20140231. <http://dx.doi.org/10.1098/rsta.2014.0231>
- 3.14 Taylor, G.I., “Eddy motion in the atmosphere,” Philosophical Transactions of the Royal Society of London (A), 215 (1915), pp. 1–26. (Read May 17, 1914) [doi:10.1098/rsta.1915.0001](https://doi.org/10.1098/rsta.1915.0001)

	Slide #
Preface	3
1. Introduction and Scope	11
2. Genesis of Fluid Dynamics (<i>Antiquity to 1750</i>)	52
3. Fluid Dynamics as a Mathematical Science (<i>1750–1900</i>)	77
4. Emergence of Computational Fluid Dynamics (<i>1900–1950</i>)	98
5. Evolution of Applied Computational Aerodynamics (<i>1950–2000</i>)	124
5.1 <i>Infancy through Adolescence (1950–1980)</i>	127
Level I: Linear Potential Methods (LPMs)	127
Level II: Nonlinear Potential Methods (NPMs)	138
5.2 <i>Pursuit of Effectiveness (1980–2000)</i>	163
Level III: Euler Methods	167
Level IV: Reynolds-Averaged Navier-Stokes (RANS) Methods	210
6. ACA Effectiveness: Status and Prospects (<i>2000 and Beyond</i>)	229
6.1 <i>Assessment of Effectiveness (2000–2020)</i>	231
6.2 <i>Prospects for Fully Effective ACA (Beyond 2020)</i>	261
7. Closing Remarks	286
Appendix A	295

At the Dawn of the 20th Century...

- **17 December 1903 to be precise—the first manned, controlled, powered flight by the Wright brothers!**

Orville Wright's telegram to his father:

Success. Four flights Thursday morning. All against twenty one mile wind. Started from level with engine power alone. Average speed through air thirty one miles. Longest 57 seconds. Inform press.

Home Christmas.

“This flight lasted only twelve seconds, but it was nevertheless the first in the history of the world in which a machine carrying a man had raised itself by its own power into the air in full flight, had sailed forward without reduction of speed and had finally landed at a point as high as that from which it started.

- Orville Wright

- **Dramatic evolution of civil and military aviation followed**

...12 Seconds Changed Human History Forever!

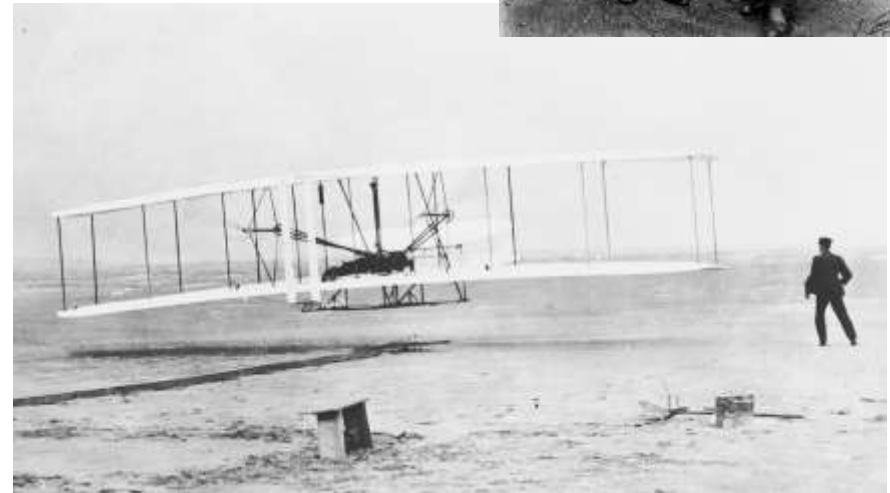

Analytical Fluid Dynamics

State of the Art at the Dawn of the 20th Century

- **AFD witnessed notable advances over preceding 150 years (1750–1900)**
 - Development of the governing equations of inviscid (Euler) and viscous flows (Navier-Stokes & RANS)
 - Advances in mathematics provided novel tools and techniques (such artifacts as sources, sinks, doublets, vortex filaments, etc.) that could be used to obtain analytical solutions of irrotational (potential) and rotational flows of perfect or ideal fluids
- **But available AFD capabilities woefully inadequate to meet the emerging need of airplane engineering design**
- **AFD offered no satisfactory solution for the problem of resistance—a key need for airplane design!**
 - ***d’Alembert’s paradox (1749-1752) remains unresolved!***
 - *“In a velocity field that is uniform at infinity and tangent to the body along its surface... [body] would suffer no force from the fluid, which is contrary to experience”*
 - **“Surface of Discontinuity” Theory proposed by Hermann von Helmholtz (1858-1868)**
 - *“Any geometrically complete sharply-defined edge at which fluids flow past must tear itself from the most typical velocity of the remaining fluid and define a separation surface.”*
 - Whole resistance being then due to the excess pressure region in front of the body, the dead-water or wake being at approximately the hydrostatic pressure of the fluid.

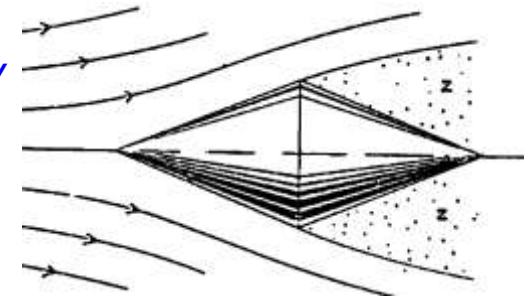

Analytical Fluid Dynamics

The Problem of Resistance Challenged Even the Brightest Minds!

On the Resistance of Fluids (Lord Rayleigh F.R.S.)

The London, Edinburgh, and Dublin Philosophical Magazine and Journal of Science,
2:13, 430-441, 1876

(Nearly 125 years after d'Alembert's Paradox was published!)

"There is no part of hydrodynamics more perplexing to the student than which treats the resistance of fluids. According to one school of writers a body exposed to a stream of perfect fluid would experience no resultant force at all, any augmentation of pressure on its face due to the stream being compensated by equal and opposite pressures on its rear... On the other hand it is well known that in practice an obstacle does experience a force tending to carry it downstream and of magnitude too great to be the direct effect of friction; while in many of the treatises calculations of resistance are given leading to results depending on the inertia of the fluid without any reference to friction."

**John William Strutt
3rd Baron Rayleigh**



Nobel Prize in Physics (1904)
12 Nov 1842 – 30 Jun 1919

***Prevailing Wisdom:
Fluid Friction Too Small to Produce Significant Resistance Force!***

Finally a Breakthrough in 1904!

Prandtl's Boundary Layer Theory

Über Flüssigkeitsbewegung bei sehr kleiner Reibung.

Verhandlungen Des Dritten Internationalen Mathematiker-Kongresses,
 Heidelberg, Vom 8, Bis 13, August 1904, pp 484-491

Ludwig Prandtl



German Physicist

4 Feb 1875 – 15 Aug 1953

2D BL velocity profile

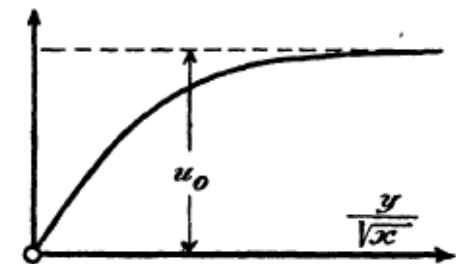

Fig. 1.



Less than eight pages!

2D BL equations

$$\rho \left(u \frac{\partial u}{\partial x} + v \frac{\partial u}{\partial y} \right) + \frac{dp}{dx} = k \frac{\partial^2 u}{\partial y^2}$$

$$\frac{\partial u}{\partial x} + \frac{\partial v}{\partial y} = 0.$$

“The most important aspect of the problem is the behavior of the fluid on the surface of the solid body. The physical processes in the boundary layer [Grenzschicht] between fluid and solid body can be calculated in a sufficiently satisfactory way if it is assumed that the fluid adheres to the walls, so that the total velocity is either zero or equal to the velocity of the body. If, however, the viscosity is very small and the path of the fluid along the wall not too long, the velocity will have its normal value very near to the wall. In the thin transition layer (Übergangsschicht) the sharp changes of velocity, in spite of the small viscosity coefficient, produce noticeable effects.”

“A Most Extraordinary Paper of the 20th Century, and Probably of Many Centuries!” – Sydney Goldstein, Harvard Univ.

Prandtl's Solution of Boundary Layer Equations

Über Flüssigkeitsbewegung bei sehr kleiner Reibung.

Verhandlungen Des Dritten Internationalen Mathematiker-Kongresses,
Heidelberg, Vom 8, Bis 13, August 1904, pp 484-491

“If, as usual, dp/dx is given throughout, and furthermore the variation of u for the initial cross-section of the flow, then every problem of this kind may be mastered numerically, in that one can obtain from every value of u the corresponding $\partial u/\partial x$ by quadrature. With this and the help of one of the familiar approximate methods, one can repeatedly move a step at a time in the x direction. Of course a difficulty exists with various singularities arising at solid boundaries. The simplest case of the flow situations considered here is the one in which water flows along a thin flat plate. A reduction in the variables is possible here; one can put $u = f\left(\frac{y}{\sqrt{x}}\right)$. One comes up with a formula for the flow resistance using a numerical result of the resulting [ordinary] differential equation

$$R = 1.1 \cdots b \sqrt{k \rho l u_0^3}$$

(b width, l length of the plate, u_0 the velocity of the undisturbed water opposite the plate).”

- The corresponding skin-friction drag coefficient (for both surfaces of the plate) is

$$C_F = 2.2/\sqrt{Re} \text{ where } Re = \frac{(\rho u_0 l)}{k}$$

- More accurate calculations later corrected the factor 2.2 to 2.656

Ludwig Prandtl



German Physicist
4 Feb 1875 – 15 Aug 1953

A Remarkable Achievement!

Boundary Layer Separation and Vortex Generation

Über Flüssigkeitsbewegung bei sehr kleiner Reibung.

Verhandlungen Des Dritten Internationalen Mathematiker-Kongresses,
Heidelberg, Vom 8, Bis 13, August 1904, pp 484-491

“The most important result of the investigation for application is that, in certain cases, the flow will separate from the wall at a place completely determined by the external conditions. A fluid layer, which has been set in rotation by the friction at the wall, makes its way into the free fluid where, causing a complete transformation in the motion, it plays the same role as the Helmholtz surface of discontinuity.”

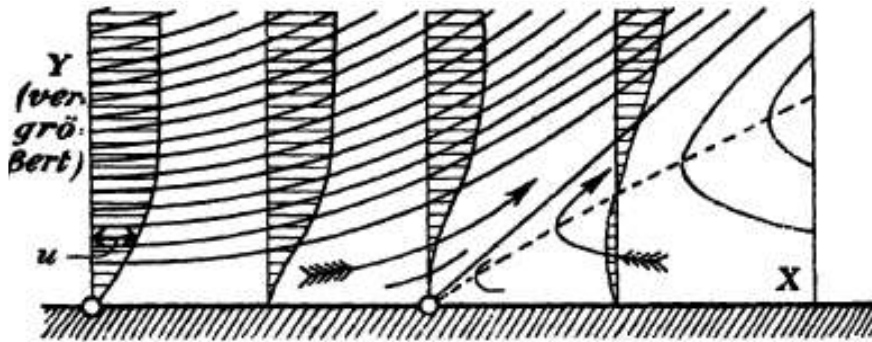

Fig. 2.

Necessary condition for flow separation:

pressure increase along the surface in the flow direction

Ludwig Prandtl



German Physicist

4 Feb 1875 – 15 Aug 1953

“A change in the viscosity coefficient k alters the thickness of the vortex layer (proportional to $\sqrt{kl/\rho u}$) but everything else remains unchanged. Therefore, one can go over to the limit $k = 0$ and obtain the same flow picture.”

A Singular Contribution of Enormous Lasting Influence for Explaining Otherwise Baffling Fluid Flow Phenomena

Aerodynamics: State of the Art (1907)

F. W. Lanchester



British Engineer
23 Oct 1868 - 8 Mar 1946

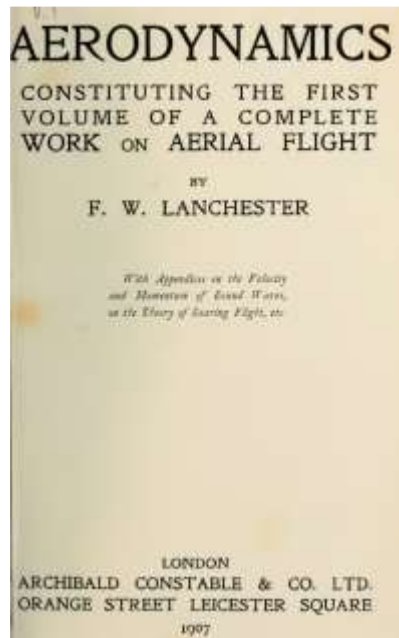

“...the author desires to record his conviction that the time is near when the study of Aerial Flight will take its place as one of the foremost of the applied sciences, one of which the underlying principles furnish some of the most beautiful and fascinating problems in the whole domain of practical dynamics.”

“In order that real and consistent progress should be made in Aerodynamics and Aerodnetics, apart from their application in the engineering problem of mechanical flight, it is desirable, if not essential, that provision should be made for the special and systematic study of these subjects in one or more of our great Universities, provision in the form of an adequate endowment with proper scope for its employment under an effective and enlightened administration.”

“...the country in which facilities are given for the proper theoretical and experimental study of flight will inevitably find itself in the best position to take the lead in its application and practical development.”

“Numerical work has been done by the aid of an ordinary 25 cm. slide rule, with a liability to error of about 1/5th of 1 percent, an amount which is quite unimportant.”



In Early 1900s, Aerodynamics Became a Most Exciting Research Frontier!
The First Half of the 20th Century: Golden Age of Analytical Aerodynamics

Analytical Aerodynamics: 1900s

A Small Sampling of Pioneering Research

- **Kutta (1902)** – solution of inviscid 2D flow about circular-arc body at zero incidence with circulation and finite velocity at trailing edge

Martin Kutta

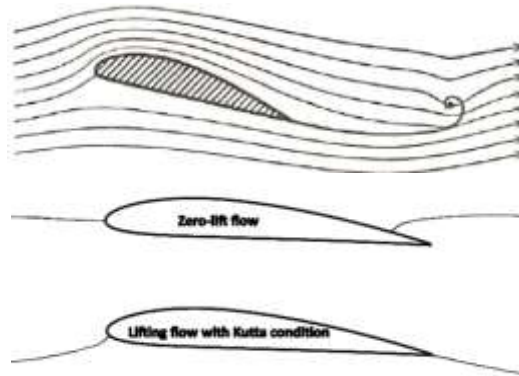

$$l = \rho \Gamma V$$

German Mathematician

3 Nov 1867 – 25 Dec 1944

- **Prandtl-Meyer (1908)** – oblique shocks and expansion fans in supersonic flows
- **Zhukovskii (1910)** design of airfoil sections using graphical construction

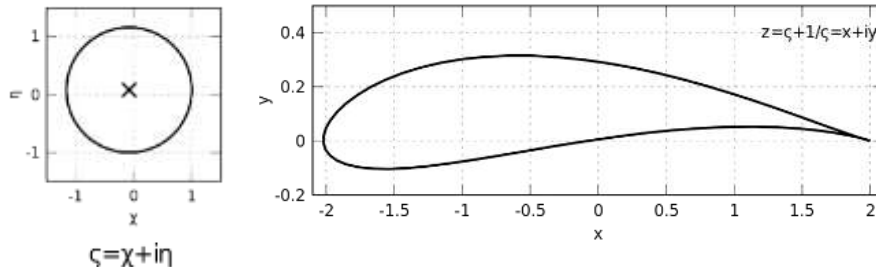

- **Prandtl (1904)** – boundary layer theory and vortex generation
- **Zhukovskii (1906)** – circulation theory of lift on 2D airfoils

- **Chaplygin (1910)**

Postulate: “out of infinite number of theoretically possible solutions past an airfoil with sharp trailing edge, the flow that’s nearest to experiment is the one with finite velocity at the trailing edge”

Nikolay Zhukovskiy



Russian Scientist,
Mathematician

5 Jan 1847 – 17 Mar 1921

Sergey Chaplygin



Russian Physicist,
Mathematician, Engineer

5 Apr 1867 – 8 Oct 1942

Analytical Aerodynamics: 1910s

A Small Sampling of Pioneering Research

- **Kármán (1911)** – first paper on vortex street in the wake of 2D cylinders; referred to Boundary Layer theory to explain vortex formation
- **Blasius (1912)** – friction factor in turbulent pipe flows varied as inverse of the 1/4th power of Reynolds number, and velocity as the 1/7th power of the distance from the wall
- **Prandtl (1914)** – explained small drag coefficients for spheres with turbulent boundary layer that were first demonstrated by Eiffel in 1912

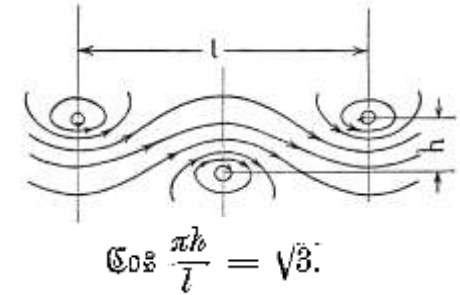

- **Prandtl (1918-1919)** – classic papers on 3D airfoil (wing) theory of large but finite aspect ratio

$$W = \rho \int_a^b \Gamma w dx$$

$$w(x) = \frac{1}{4\pi} \int_a^b \frac{d\Gamma}{dx'} \cdot \frac{dx'}{x-x'}$$

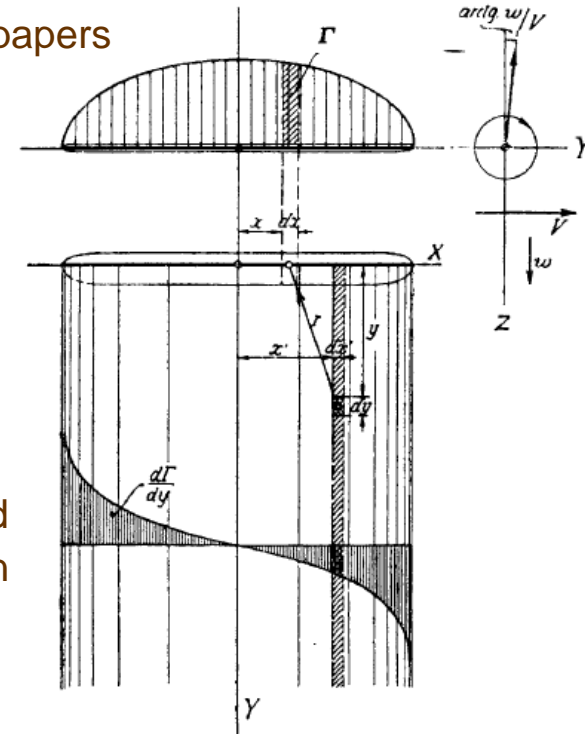

Fig. 4')

- **Munk (1918)** – the term “induced drag” and the now well-known “Munk’s stagger theorem”
- **Betz (1919)** – screw propeller with minimum energy loss

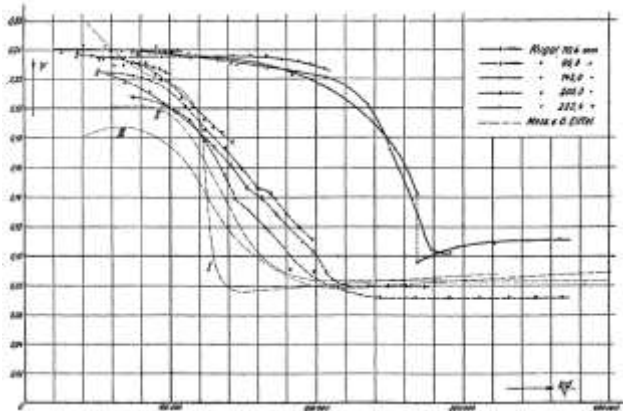

Figure 1.

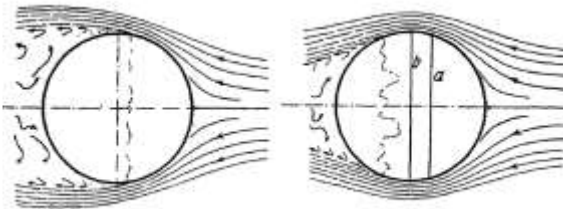

Figure 3.

Figure 4.

Analytical Aerodynamics: 1920s

A Small Sampling of Pioneering Research

- **Trefftz (1921)** – extract induced drag from wake integral in a far downstream “Trefftz plane”
- **Kármán (1921)** – momentum equations of boundary layer, and Kármán-Pohlhausen approximate method of integration

$$\frac{\partial}{\partial t} \int_0^{\delta} \rho u dy + \frac{\partial}{\partial x} \int_0^{\delta} \rho u^2 dy - u_0 \frac{\partial}{\partial x} \int_0^{\delta} \rho u dy = -\delta \frac{\partial P}{\partial x} - R$$

$\tau_0 = \mu \left(\frac{\partial u}{\partial y} \right)_{y=0}$

Flat plate skin friction formulas for laminar & turbulent boundary layers!

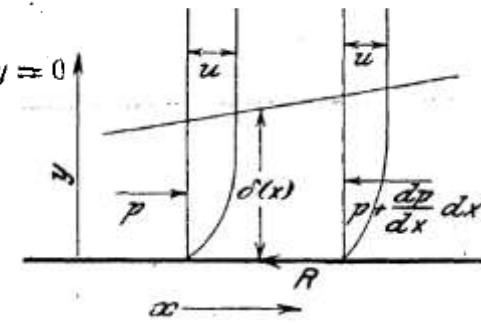

- **Taylor (1923)** – “Stability of viscous liquid contained between two rotating cylinders”

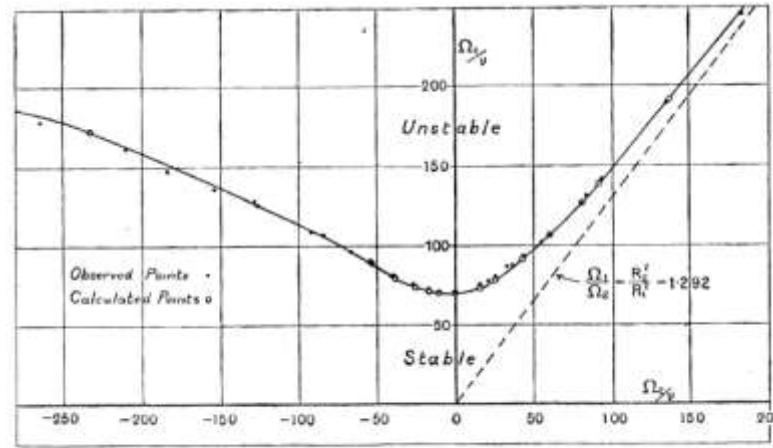
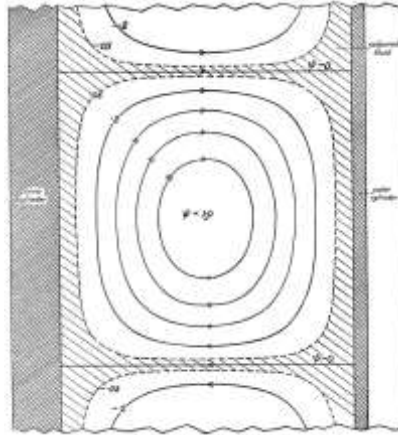

Fig. 18. Comparison between observed and calculated speeds at which instability first appears; case when $R_1 = 3.55$ cm., $R_2 = 4.035$ cm.

Theodore von Kármán



Hungarian-American
Mathematician, Physicist,
Aerospace Engineer
11 May 1881 – 6 May 1963

- **Prandtl (1925)** – “mixing path (or distance) theory” for turbulent flows with the proposition: *momentum is a transferable property*

$$\tau = \rho l^2 \left| \frac{du}{dy} \right| \cdot \frac{du}{dy} \quad \mu_T = \rho l^2 \left| \frac{du}{dy} \right| \quad \text{“...a first rough approximation.”}$$

- **Glauert (1928)** – Prandtl-Glauert rule for inviscid compressible flows: $C_p = C_{p0}/\beta$ $\beta^2 = 1 - M_\infty^2$

Analytical Aerodynamics: 1930s

A Small Sampling of Pioneering Research

- **Kármán (1930)** – logarithmic “law of the wall” for planar turbulent flows

$$U_{\max} - U = -\frac{1}{k} \sqrt{\frac{\tau_0}{\rho}} \left(\log \left(1 - \sqrt{\frac{y}{h}} \right) + \sqrt{\frac{y}{h}} \right)$$

- U_{\max} is the difference between wall and channel center
- k is a constant independent of dimensions and Reynolds number, appears to have a value 0.38
- **Taylor (1932)** – Proposed that *vorticity, not momentum, is the transferable property* in his paper entitled “The transport of vorticity and heat through fluids in turbulent motion”
- **Taylor-Maccoll (1933)** – Derived and solved an ordinary differential equation (O.D.E.) with one unknown for supersonic flow past a cone
- **Taylor (1935)** – “Statistical theory of turbulence” – whole new direction to turbulent flow research!

Predicted Law of Decay of Turbulence behind grids and honeycombs

$$\frac{U}{u'} = \frac{5x}{A^2M} + \text{constant.}$$

A = a constant, determined experimentally should be universal for all square grids; M = mesh length of a square mesh

- **Taylor (1935-37)** – modified vorticity-transfer theory with application to flow in pipes

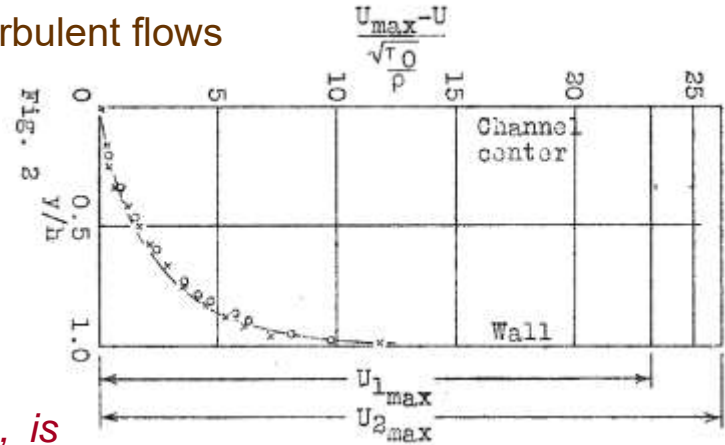

G.I. Taylor

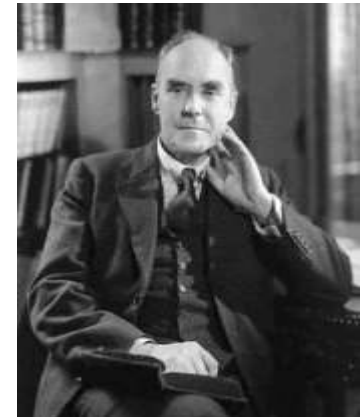

British Physicist,
Mathematician
7 Mar 1886 – 27 Jun 1975

Analytical Aerodynamics: 1940s

A Small Sampling of Pioneering Research

- **Görtler (1940)** – theoretical study of the instability of boundary layer flows on concave surfaces; instability occurs when **Görtler number**, $G > 0.3$

$$G = \frac{U_\infty \theta}{\nu} \left[\frac{\theta}{R_c} \right]^{1/2}$$

- **Busemann (1942-43)** – conical supersonic flow theory

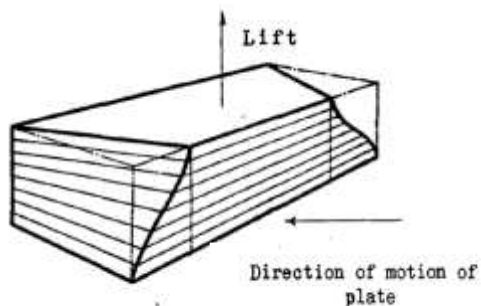
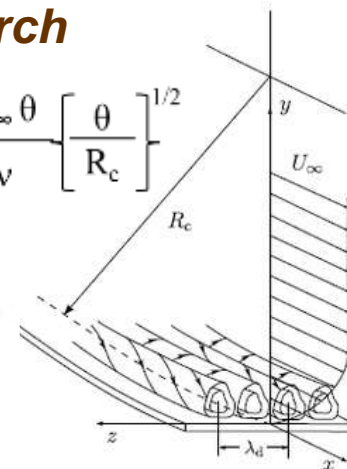

Pressure distribution on a flat plate

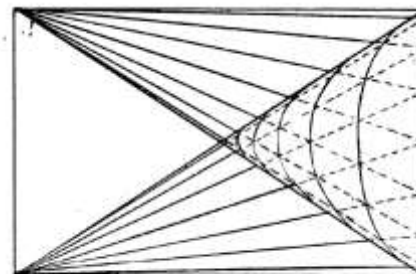

Figure 12. Superposition of edge influences for the rectangular plate at supersonic velocities

German Aerospace Engineer
20 Apr 1901 – 3 Nov 1986

- **Jones (1946)** – theory of pointed wings (delta wings) of very small aspect ratio

- **Tsien (1946)** – similarity laws of hypersonic flows

$$K = M_\infty (\delta/b)$$

- **Kármán (1947)** – similarity law of transonic flows

$$K = (1 - M_\infty)/(\tau\Gamma)^{2/3} \quad \Gamma = (\gamma+1)/2; \gamma = C_p/C_v$$

If a series of bodies of same thickness distribution but different thickness ratios (δ/b or τ) are placed in streams of different M_∞ , then the flow patterns are similar as long they all have equal values of K

- **Lighthill (1947)** – hodograph transformation in transonic flows

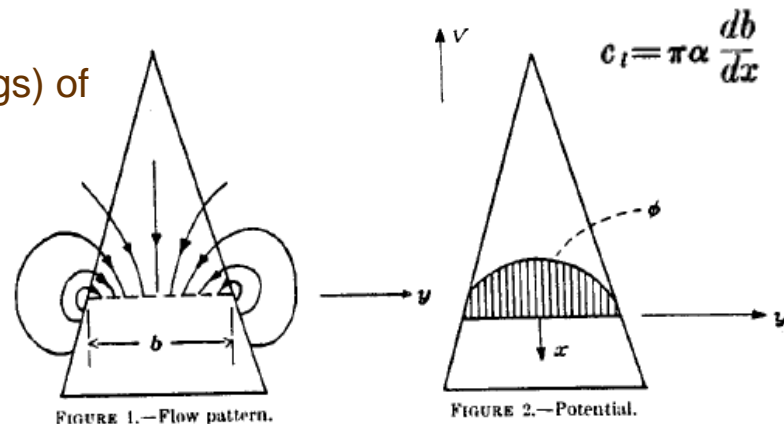

Analytical Aerodynamics (*circa 1950*)

Author's Summary Assessment of Capabilities

In spite of phenomenal advances in the first half of the 20th Century, analytical aerodynamics (*circa 1950*) remained inadequate for simulating realistic flows on *complex geometries—and remains so even today!*

“...no exact analytical model describing physically interesting flows that depend significantly on Re [Reynolds number] is known.”

– Garrett Birkhoff, 1981

Garrett Birkhoff

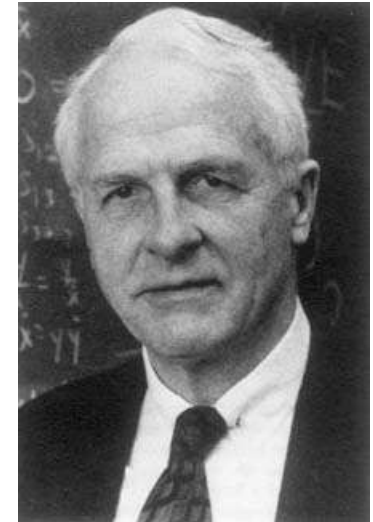

American Mathematician
19 Jan 1911 – 22 Nov 1996

Analytical Aerodynamics

***Severely limited capability of simulating realistic flows on complex geometries
But, it does not diminish its value***

“...skillful application of the equations from the dynamics of ideal fluids quite often brings clarity into such phenomena which in themselves are not independent of the viscosity. The vortex equations, in particular, proved themselves very useful. I may be allowed to mention the vortex street by which we are able to reproduce the mechanism of the form resistance with suitable approximation under stated conditions, although such a resistance is precluded in a fluid which is perfectly inviscid...Another striking example is the theory of the induced drag of wings, which likewise shows the extent of applying the vortex equations without overstepping the bounds of the dynamics of ideal fluids.”

– Theodore von Kármán, 1931

***Analytical Aerodynamics (a subset of AFD) Remains Indispensable
for Better Understanding of Complex Flow Phenomena***

Experimental Aerodynamics: 1900 – 1950

An Effective Means of Overcoming Inadequacies of AFD

Rapid advancements to support development of new airplane designs

- Bigger tunnels; high-speed tunnels; low-turbulence tunnels; special purpose tunnels; ...

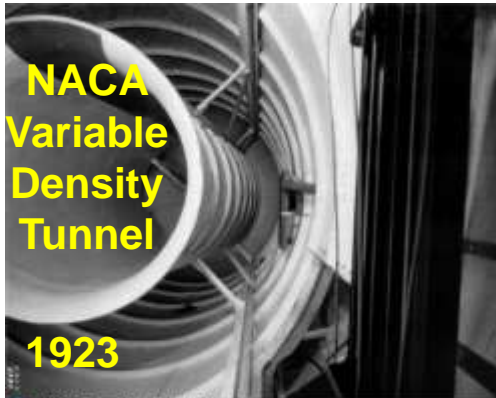

Variable Density Tunnel - Wind Tunnel #2
NASA Langley Research Center 2/14/1928 Image # EL-1999-00290

“data for 78 classical airfoil shapes: see TR 460, 1935”

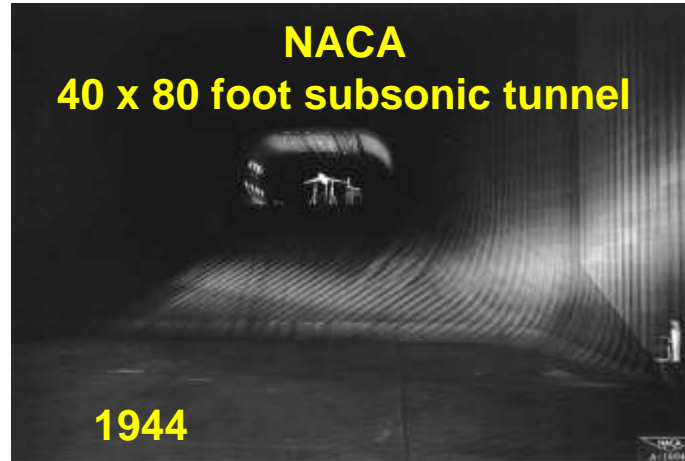

“aircraft development work”



“solve the mysteries of flight beyond Mach 1”

- Techniques and instruments for accurate measurements (e.g., hot-wire anemometry) and visualization (e.g., Schlieren, interferometry)

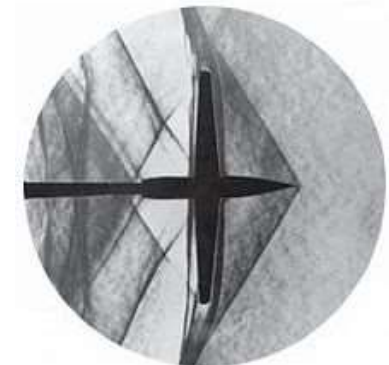
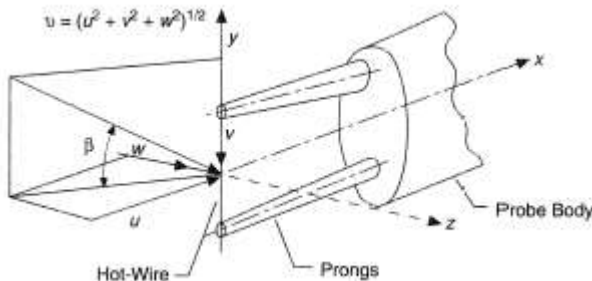

The Approximate Arithmetical Solution by Finite Differences of Physical Problems involving Differential Equations, with an Application to the Stresses in a Masonry Dam.

By L. F. RICHARDSON, *King's College, Cambridge.*

Read January 13, 1910

IX. *The Approximate Arithmetical Solution by Finite Differences of Physical Problems involving Differential Equations, with an Application to the Stresses in a Masonry Dam.*

By L. F. RICHARDSON, *King's College, Cambridge.*

Communicated by Dr. R. T. GLAZEBROOK, F.R.S.

Received (in revised form) November 2, 1909.—Read January 13, 1910.

§ 1. INTRODUCTION.—§ 1.0. The object of this paper is to develop methods whereby the differential equations of physics may be applied more freely than hitherto in the approximate form of difference equations to problems concerning irregular bodies.

Though very different in method, it is in purpose a continuation of a former paper by the author, on a "Freehand Graphic Way of Determining Stream Lines and Equipotentials" ('Phil. Mag.', February, 1908; also 'Proc. Physical Soc.,' London, vol. xxi.). And all that was there said, as to the need for new methods, may be taken to apply here also. In brief, analytical methods are the foundation of the whole subject, and in practice they are the most accurate when they will work, but in the integration of partial equations, with reference to irregular-shaped boundaries, their field of application is very limited.

Both for engineering and for many of the less exact sciences, such as biology, there is a demand for rapid methods, easy to be understood and applicable to unusual equations and irregular bodies. If they can be accurate, so much the better; but 1 per cent. would suffice for many purposes. It is hoped that the methods put forward in this paper will help to supply this demand.

The equations considered in any detail are only a few of the commoner ones occurring in physical mathematics, namely:—LAPLACE'S equation $\nabla^2\phi = 0$; the oscillation equations $(\nabla^2 + k^2)\phi = 0$ and $(\nabla^2 - k^2)\phi = 0$; and the equation $\nabla^2\phi = 0$. But the methods employed are not limited to these equations.

The Number of Independent Variables.—In the examples treated in the paper this never exceeds two. The extension to three variables is, however, perfectly obvious. One has only to let the third variable be represented by the number of the page of a book of tracing paper. The operators are extended quite simply, and the same

VOL. CCX.—A 467.

2 B 2

24.5.10

Lewis Fry Richardson



FRS, British Mathematician, Physicist,
Meteorologist, Psychologist

11 Oct 1881 – 30 Sep 1953

Richardson's Observations: 1910 Paper

*“The object of this paper is to **develop methods** whereby the **differential equations** of physics **may be applied** more freely than hitherto **in the approximate form of difference equations to problems concerning irregular bodies.**”*

*“...**analytical methods** are the foundation of the whole subject, and in practice they are the most accurate when they will work, but in the integration of partial equations, with reference to **irregular-shaped boundaries**, their **field of application is very limited.**”*

*“So far I have **paid piece rates for the** $\delta_x^2 + \delta_y^2$ **operation** of about $n/18$ pence per **coordinate point**, n being the number of digits. The chief trouble to the computers has been the intermixture of plus and minus signs. As to the rate of working, **one of the quickest boys averaged 2,000 operations** $\delta_x^2 + \delta_y^2$ **per week**, for numbers of three digits, those done wrong being discounted.”*

Extension to Fluid Flows

TO SIMULATE FLOW ABOUT IRREGULARLY SHAPED BODIES

1. Use difference form of differential equations of *fluid flow* physics.
2. Cannot apply analytical methods to irregularly shaped bodies.
3. Employ ‘computers’ [humans] to perform arithmetic operations.

What
Why
How

The What, the Why and the How of CFD (the rest is **DETAIL!)**

- **Pioneering Foundational Research in Numerical Methods**
 - **Richardson (1910)** – point iterative scheme for Laplace’s equation
 - **Liebmann (1918)** – improved version of Richardson’s method with faster convergence
 - **Courant, Friedrichs, and Lewy (1928)** – uniqueness and existence of numerical solutions of PDEs (*origins of the CFL condition well known to all “CFDers”*)
 - **Southwell (1940)** – improved relaxation scheme tailored for hand calculations
 - **Frankel (1950)** – first version of successive over-relaxation scheme for Laplace’s equation
 - **O’Brien, Hyman, and Kaplan (1950)** – von Neumann method for evaluating stability of numerical methods for time-marching problems
- **Early Adopters**
 - **Thom (1929-1933)** – flow past circular cylinders at low speeds by numerically solving steady viscous flow equations: *stream function–vorticity (ψ – ζ) formulation of the N-S equations*
 - **Kawaguti (1953)** – flow past circular cylinder at $Re = 40$
 - 232 mesh points for half flow region
 - Iterative procedure is considered converged when difference between successive approximations for ψ and ζ does not exceed 0.3% of maximum value for the last 4 cycles
 - ***“The numerical integration in this study took about one year and a half with twenty working hours every week, with a considerable amount of labor and endurance.”***

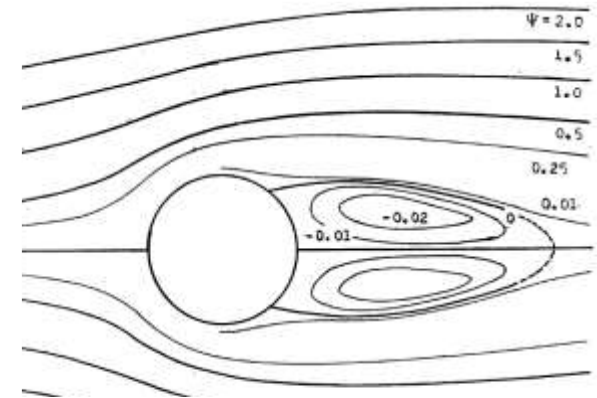

The Bottleneck: Slow & Laborious Computing

A Vision for the Future (1946)

*“Our present analytical methods seem unsuitable for the solution of the important problems arising in connection with **non-linear partial differential equations**...The truth of this statement is particularly striking in the field of **fluid dynamics**.”*

*“The **advance of analysis** is, at this moment, **stagnant** along the entire front of **non-linear problems**...Although the main mathematical difficulties have been known since the time of Riemann and of Reynolds, and although as brilliant a mathematical physicist as Rayleigh has spent a major part of his life’s effort in combating them, yet **no decisive progress has been made** against them—indeed hardly any progress which could be rated as important...”*

*“...many branches of both pure and applied mathematics are in **great need of computing instruments to break the present stalemate** created by the failure of the purely analytical approach to nonlinear problems.”*

*“... really efficient high-speed [digital] computing devices may, in the field of **non-linear partial differential equations** as well as in many other fields...provide us with those heuristic hints which are needed in all parts of mathematics for **genuine progress**.”*

These are excerpts from the first paper in Ref. 4.35 entitled “ON THE PRINCIPLES OF LARGE SCALE COMPUTING MACHINES. *This paper was never published. It contains material given by von Neumann in a number of lectures, in particular one at a meeting on **May 5, 1946**, of the Mathematical Computing Advisory Panel, Office of Research and Inventions, Navy Department, Washington, D.C. The manuscript from which this paper was taken also contained material (not published here) which was published in the Report, “Planning and Coding of Problems for an Electronic Computing Instrument”.*

John von Neumann



Hungarian-American
Mathematician, Physicist,
Computer Scientist
28 Dec 1903 – 8 Feb 1957
1999 Financial Times
Person of the Century

Digital Computers: 1930 – 1950

- **Alan Turing (1936)** – *a universal machine capable of computing anything that is computable*
- **Atanasoff (1937)** – *first computer without gears, cams, belts and shafts*
- **Atanasoff and Berry (1941)** – *a computer that can solve 29 equations simultaneously, and store information on its main memory*
- **Mauchly and Eckert (1943-44)** – *Electronic Numerical Integrator and Calculator (ENIAC) using 18,000 vacuum tubes*
 - ✓ Speed: 500 floating point operations per second
 - ✓ Size: 1,800 square feet
- **Mauchly and Presper (1946)** – *Universal Automatic Computer (UNIVAC), the first commercial computer for business and government*

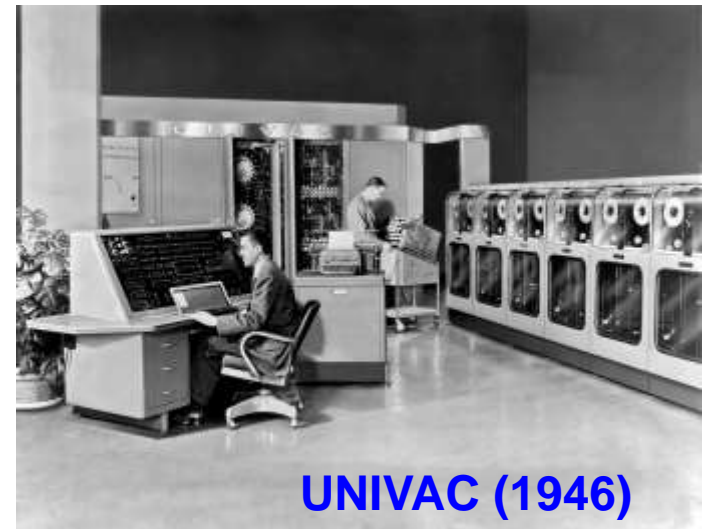

The Key to Converting von Neumann's Vision into Reality!

Section 4. Overarching Takeaways

By 1950, all fundamental ingredients were in place for the evolution of an exciting new field of [what we call] Computational Fluid Dynamics (CFD).

In the second half of the 20th century, phenomenal advances in CFD methods and computing capabilities fueled the evolution of Applied Computational Aerodynamics (ACA).

ACA Evolution was Fueled by the Promise of CFD Serving as a Powerful “Alternative” to AFD and EFD for Simulating Aerodynamics of Irregularly Shaped Bodies!

Section 4: Key Takeaways

- **1903: the first manned, controlled, powered flight by the Wright brothers!**
- **Even after 150 years of noteworthy progress, Analytical Fluid Dynamics woefully inadequate to meet the emerging airplane design needs**
 - No solution of the problem of resistance in sight. *d'Alembert's paradox rules!*
- **1904: A breakthrough—Prandtl's Boundary Layer theory!**
 - *"A most extraordinary paper of the 20th century, and probably of many centuries!"*
- **The first 50 years of the 20th century (1900-1950) witnessed phenomenal advances in Analytical Aerodynamics, but...analytical models remained inadequate for simulating realistic flows on irregularly shaped bodies**
 - EFD provided the best means of solving practical engineering problem
- **1910: Richardson laid the foundation of Numerical Fluid Dynamics**
 - Use difference form of differential equations; employ human computers to perform resulting arithmetic operations; applicable to irregularly shaped bodies, but...
 - Human computers were the bottleneck!
- **1930 - 1950: Digital computers evolved**
 - Key to realizing von Neumann's 1946 vision: *"really efficient high-speed [digital] computing devices may break the present stalemate created by the failure of the purely analytical approach to nonlinear problems"*

By 1950, all basic ingredients were in place for the evolution of Computational Fluid Dynamics (CFD)

BIBLIOGRAPHY

SECTION 4

4. Emergence of Computational Fluid Dynamics (1900–1950)

- 4.1 Torenbeek, E. and Whittenberg, H., Flight Physics: Essentials of Aeronautical Disciplines and Technology, with Historical Notes, Springer, 2002.
- 4.2 Helmholtz, H., "Ueber discontinuirliche Flüssigkeitsbewegungen," Monatsberichte d. königl. Akad. d. Wiss. zu Berlin (1868), 215-228 (English translation by D.H. Delphenich http://www.neo-classical-physics.info/uploads/3/4/3/6/34363841/helmholtz_-_discontinuous_fluid_motions.pdf)
- 4.3 Lanchester, F.W., Aerodynamics: Constituting the First Volume of a Complete Work on Aerial Flight, London, 1907. <https://openlibrary.org/books/OL7000267M/Aerodynamics>
- 4.4 Lord Rayleigh, F.R.S, "On the resistance of fluids," The London, Edinburgh, and Dublin Philosophical Magazine and Journal of Science, 2:13, 1876, 430-441. <https://www.tandfonline.com/doi/abs/10.1080/14786447608639132>
- 4.5 Prandtl, L., "Über Flüssigkeitsbewegung bei sehr kleiner Reibung," Verhandlungen Des Dritten Internationalen Mathematiker-Kongresses, Heidelberg, Vom 8, Bis 13, August 1904. <https://www.mathunion.org/fileadmin/ICM/Proceedings/ICM1904/ICM1904.ocr.pdf>
- 4.6 Goldstein, S., "Fluid Mechanics in the First Half of this Century," Sears and van Dyke (eds.), Annual Review of Fluid Mechanics, Volume I, 1969. <https://doi.org/10.1146/annurev.fl.01.010169.000245>
- 4.7 Prandtl, L. and Tietjens, O.G., Applied Hydro- and Aeromechanics, Dover Publications, New York, 1957.
- 4.8 Kutta, M.W., Auftriebskräfte in strömenden Flüssigkeiten. Illustrierte Aeronautische Mitteilungen, 6, 133–135, 1902.
- 4.9 Joukowski, N. E., (1910). "Über die Konturen der Tragflächen der Drachenflieger", Zeitschrift für Flugtechnik und Motorluftschiffahrt (in German), 1: 281–284, 1910.
- 4.10 Kármán, Th. von, "Ueber den Mechanismus des Widerstandes, den ein bewegter Körper in einer Flüssigkeit erfährt." Nachrichten von der Gesellschaft der Wissenschaften zu Göttingen, Mathematisch-Physikalische Klasse 1911 (1911): 509-517. <http://eudml.org/doc/58812>.
- 4.11 Blasius H., Das Aehnlichkeitsgesetz bei Reibungsvorgängen, Z Ver Dtsch Ing 56(16), 1912: 639–643. https://zenodo.org/record/1447405#.XtpF_ud7lPY
- 4.12 Prandtl, L., "Der Luftwiderstand von Kugeln," Nachrichten der Gesellschaft der Wissenschaften zu Göttingen, Mathematisch-Physikalische Klasse, 1914: 177–190.
- 4.13 Prandtl, L. and Betz, A., Vier Abhandlungen zur Hydrodynamik und Aerodynamik, Göttingen, 1927.
- 4.14 Kármán, Th. v. "Über laminare und turbulente Reibung." Zeitschrift für Angewandte Mathematik und Mechanik (ZAMM-Journal of Applied Mathematics and Mechanics) 1.4: 233–252, 1921. <https://doi.org/10.1002/zamm.19210010401>

BIBLIOGRAPHY

SECTION 4 (contd.)

- 4.15 Taylor, G.I., “Stability of a Viscous Liquid Contained between Two Rotating Cylinders,” Philosophical Transactions of the Royal Society of London. Series A, Vol. 223 (1923), pp. 289-343. <https://www.jstor.org/stable/91148>
- 4.16 Prandtl, L., “Bericht über Untersuchungen zur ausgebildeten Turbulenz,” Zeitschrift für Angewandte Mathematik und Mechanik, 5.2: 136-139, 1925. <https://doi.org/10.1002/zamm.19250050212>
- 4.17 Prandtl, L., “Turbulent Flows,” NACA TM-435, October 1927.
<https://ntrs.nasa.gov/archive/nasa/casi.ntrs.nasa.gov/19930090799.pdf>
(English translation of the lecture, Ueber die ausgebildete Turbulenz, delivered before the International Congress for Applied Mechanics, Zurich, September 1926)
- 4.18 Glauert, H., “The effect of compressibility on the lift of an aerofoil,” ARC, R & M No 1135, 1927. (See also: Proceedings of the Royal Society A, 118, 1928, pp. 113-119. <https://doi.org/10.1098/rspa.1928.0039>)
- 4.19 Kármán, Th. v., “Mechanical Similitude and Turbulence,” NACA TM-611, March 1931.
<https://ntrs.nasa.gov/archive/nasa/casi.ntrs.nasa.gov/19930094805.pdf>
(English translation of Mechanische Ähnlichkeit und Turbulenz, Nachrichten von der Gesellschaft der Wissenschaften zu Göttingen, 1930, Fachgruppe 1. (Mathematik) No. 5, pp. 58-76)
- 4.20 Taylor, G. I., “Statistical Theory of Turbulence.” Proceedings of the Royal Society of London. Series A, Mathematical and Physical Sciences, vol. 151, no. 873, pp. 421-444, 1935. www.jstor.org/stable/96557
- 4.21 Jones, R.T., “Properties of Low-Aspect-Ratio Pointed Wings at Speeds Below and Above the Speed of Sound,” NACA TR-835, 1946. <https://ntrs.nasa.gov/archive/nasa/casi.ntrs.nasa.gov/19930091913.pdf>
- 4.22 Tsien, H., “Similarity Laws of Hypersonic Flows,” Studies in Applied Mathematics, Vol. 25, Issue 1-4, April 1946, pp. 247-251. <https://doi.org/10.1002/sapm1946251247>
- 4.23 Kármán, Th. v., “The Similarity Law of Transonic Flow,” Studies in Applied Mathematics, Vol. 26, Issue 1-4, April 1947, pp. 182-190. <https://doi.org/10.1002/sapm1947261182>
- 4.24 Busemann, A., Infinitesimal Conical Supersonic Flow, NACA TM-1100, March 1947.
<https://ntrs.nasa.gov/archive/nasa/casi.ntrs.nasa.gov/20030064044.pdf>
(Translated from German original: “Infinitesimale kogelige Überschallströmung,” Deutschen Akademie der Luftfahrtforschung, 1942-43, p. 455)
- 4.25 Lighthill, M.J., “The Hodograph Transformation in Trans-sonic Flows. I. Symmetrical Channels and II. Auxiliary theorems on the hypergeometric functions $\psi_n(\tau)$,” Proceedings of the Royal Society A, 191, 1947, pp. 323-341. <https://www.jstor.org/stable/98041>
- 4.26 Birkhoff, G., “Numerical Fluid Dynamics,” SIAM Review, Vol. 25, No. 1, January 1983. <https://doi.org/10.1137/1025001>

BIBLIOGRAPHY

SECTION 4 (contd.)

- 4.27 <http://www.thermopedia.com/content/853/>
- 4.28 https://en.wikipedia.org/wiki/Schlieren_photography
- 4.29 https://en.wikipedia.org/wiki/Lewis_Fry_Richardson
- 4.30 Richardson, L.F., “The Approximate Arithmetical Solution by Finite Differences of Physical Problems Involving Differential Equations, with an Application to the Stresses in a Masonry Dam,” Philosophical Transactions of the Royal Society of London. Series A, Containing Papers of a Mathematical or Physical Character, Vol. 210 (1911), pp 307-357.
<https://www.jstor.org/stable/90994>
- 4.31 Thom, A., “Investigation of Fluid Flow in Two Dimensions,” Aeronautical Research Committee, Reports & Memoranda No. 1194, Nov 1928 (Printed in 1929). <https://reports.aerade.cranfield.ac.uk/bitstream/handle/1826.2/1474/arc-rm-1194.pdf?sequence=1&isAllowed=y>
- 4.32 Thom, A., “The Flow Past Circular Cylinders at Low Speeds,” Proceedings of the Royal Society A, Vol. 141, Issue 845, 01 Sept 1933. <https://royalsocietypublishing.org/doi/10.1098/rspa.1933.0146>
- 4.33 Kawaguti, M., “Numerical Solution of the Navier-Stokes Equations for the Flow around a Circular Cylinder at Reynolds Number 40,” Journal of the Physical Society of Japan, Vol.8, No. 6, Nov-Dec 1953.
- 4.34 https://en.wikipedia.org/wiki/John_von_Neumann
- 4.35 Goldstine, H.H. and von Neumann, J., “On the Principles of Large Scale Computing Machines,” John von Neumann Collected Works, Volume V: Design of Computers, Theory of Automata and Numerical Analysis, A.H. Taub (General Editor), Pergamon Press, 1963, pp. 1-33.
- 4.36 <https://www.livescience.com/20718-computer-history.html>

	Slide #
Preface	3
1. Introduction and Scope	11
2. Genesis of Fluid Dynamics (<i>Antiquity to 1750</i>)	52
3. Fluid Dynamics as a Mathematical Science (<i>1750–1900</i>)	77
4. Emergence of Computational Fluid Dynamics (<i>1900–1950</i>)	98
5. Evolution of Applied Computational Aerodynamics (<i>1950–2000</i>)	124
5.1 <i>Infancy through Adolescence (1950–1980)</i>	127
Level I: Linear Potential Methods (LPMs)	127
Level II: Nonlinear Potential Methods (NPMs)	138
5.2 <i>Pursuit of Effectiveness (1980–2000)</i>	163
Level III: Euler Methods	167
Level IV: Reynolds-Averaged Navier-Stokes (RANS) Methods	210
6. ACA Effectiveness: Status and Prospects (<i>2000 and Beyond</i>)	229
6.1 <i>Assessment of Effectiveness (2000–2020)</i>	231
6.2 <i>Prospects for Fully Effective ACA (Beyond 2020)</i>	261
7. Closing Remarks	286
Appendix A	295

ACA for Aircraft Design Today

Four Levels of CFD Capabilities

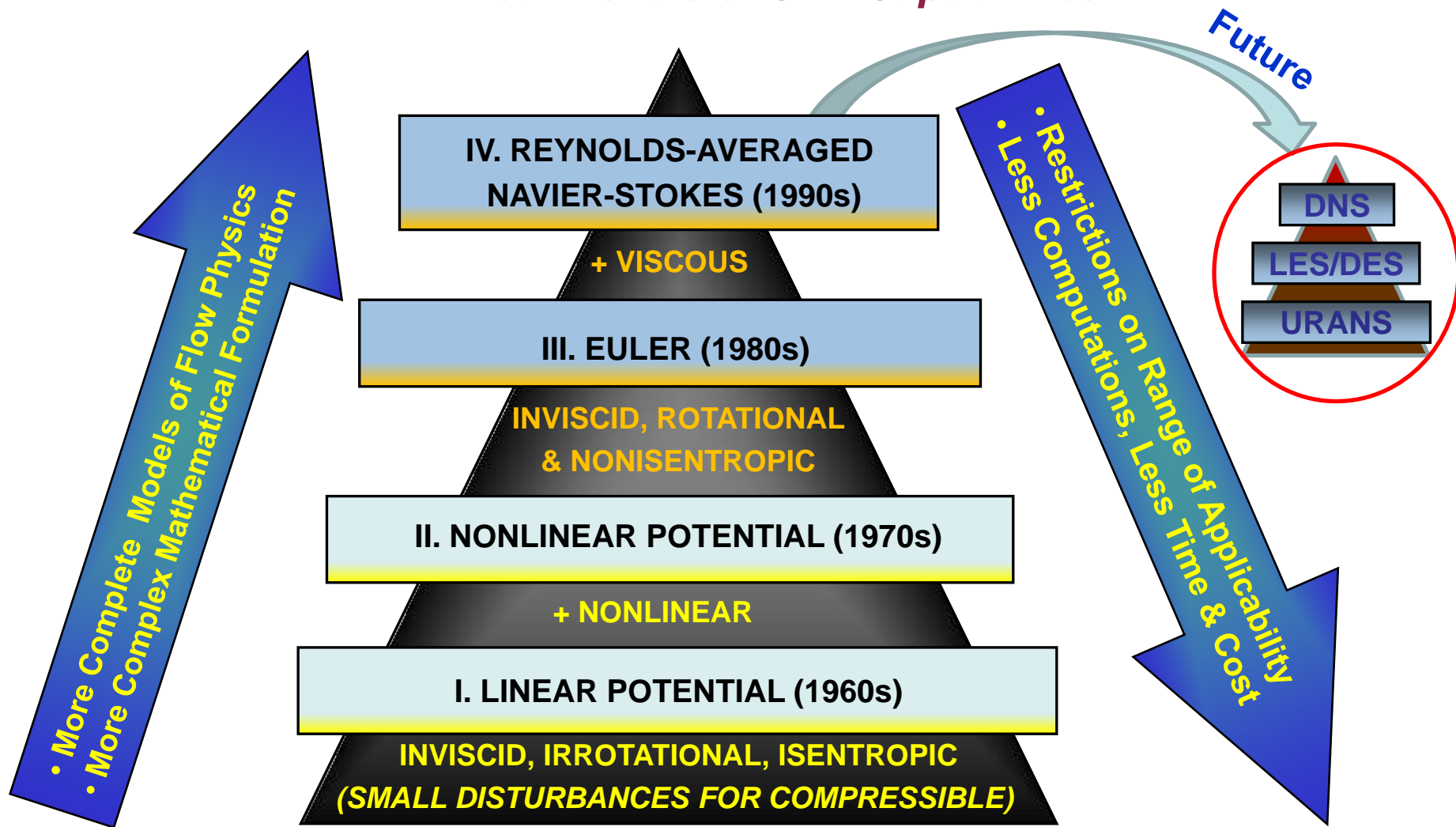

Evolution Paced by Impressive Advances Since 1950s

Note: Time frames in parenthesis indicate *widespread* adoption by industry

Approximations of N-S Equations Mapped to Four Levels of CFD

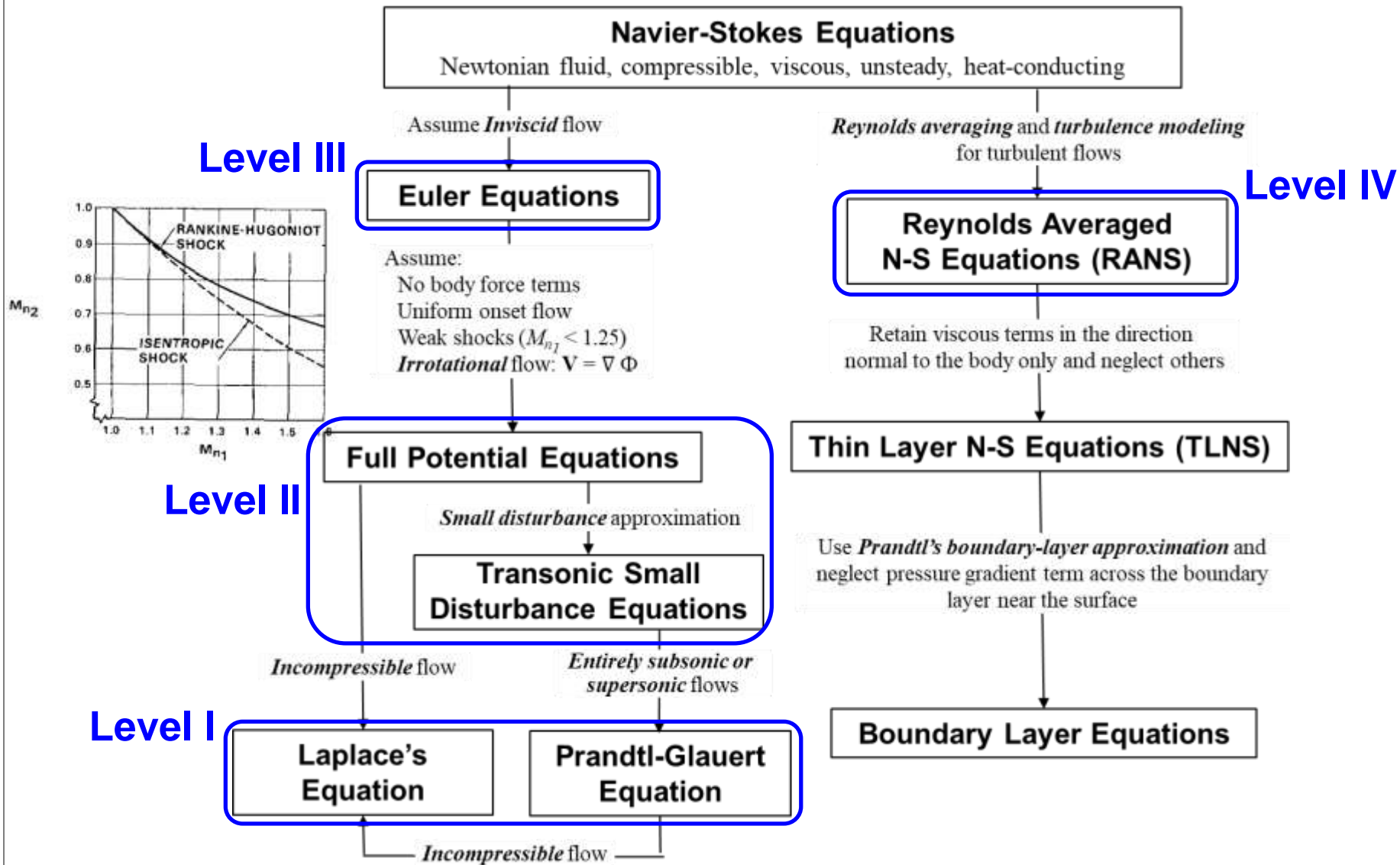

Adapted from Fig. 2-10, Configuration Aerodynamics by W.H. Mason

On “Fidelity” and “Credibility” of CFD Methods for Aerodynamic Simulations

- Many developers of CFD methods characterize “*lower level*” methods (potential [flow] methods) as “*low fidelity*” and “*higher level*” (Euler and RANS) as “*high fidelity.*” *Fidelity* in this context may be a reflection of *comprehensiveness of flow physics models*, but, for many CFD practitioners, it has the implication of *credibility (replicating reality)*
- Experience has shown that ***higher level RANS methods do not necessarily produce credible (realistic) results especially for complex flows*** that are dominated by vortices and boundary-layer separation. Therefore, one could argue that RANS methods for such applications should not be characterized as “*high fidelity.*” When considering *fidelity*, more is not always better. **Using the “highest fidelity” CFD in all instances can lead to misuse of valuable resources.**
- Since each CFD method is (should be?) carefully designed to solve a selected set of equations as *accurately* as possible, a potential flow method may not be inherently low fidelity—as long as the method is *accurately* solving the governing potential flow equations, and producing *credible* results for the target application.
- **For ACA, it’s the *credibility of aerodynamic data* that is of utmost importance. The data must be credible enough for customer to use it for making decisions without incurring undue risk. This requires that data produced by a CFD method replicate reality. Validation is the most common approach for assessing credibility—albeit not without its own set of challenges to be highlighted later.**

What Matters to the Customer is Results, Not Tools

Level I

Linear Potential Methods

1950s – present

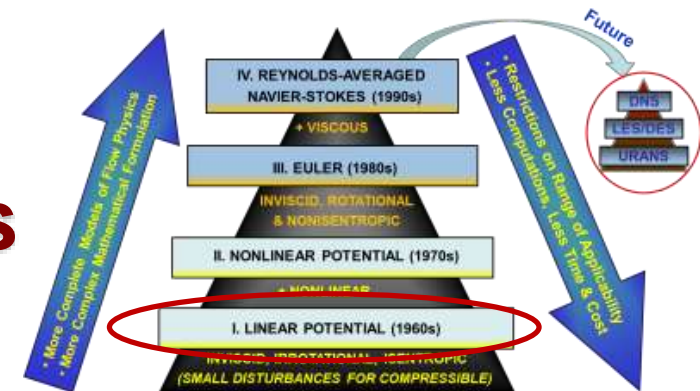

Flow Model

- Inviscid, Irrotational, Isentropic (*Small Disturbances for Compressible Flow*)

$$\mathbf{U} = \mathbf{U}_\infty + \nabla\phi$$

$$(\phi_{tt} + 2\mathbf{U}_\infty \phi_{xt}) / a_\infty^2 = (1 - M_\infty^2) \phi_{xx} + \phi_{yy} + \phi_{zz}$$

- ✓ Linear second-order PDEs with appropriate boundary conditions
- ✓ Laplace's equation for steady, incompressible flow
- ✓ Prandtl-Glauert equation for steady, compressible flow
- ✓ *Wakes not captured as part of the solution—must be explicitly modeled*

Applicability

- Attached flows that are entirely subsonic or supersonic; *not transonic*
- Flows not dominated by shocks, vortices, or boundary-layer separation

Linear Potential Methods (LPMs)

Overview

- **Basic Formulation**
 - Discretize geometry into small elements
 - Distribute singularities (source, doublets, vortex filaments) on each element
 - Impose no-normal-flow boundary condition (BC) at control points (one per element), and Kutta condition at sharp trailing edge
 - Solve system of linear algebraic equations to determine singularity strengths
 - Use Bernoulli's equation to compute airloads
- **Vortex Lattice Methods (VLMs)**
 - *Geometry*: mean surface
 - *Singularity type*: horseshoe vortices
 - *BCs*: control points on mean surface
 - *Airloads*: net pressure
- **Panel Methods**
 - *Geometry*: actual surface
 - *Singularity type*: sources, doublets or both
 - *Singularity distribution*: constant, linear or higher order
 - *BCs*: control points on actual surface
 - *Airloads*: actual surface pressures

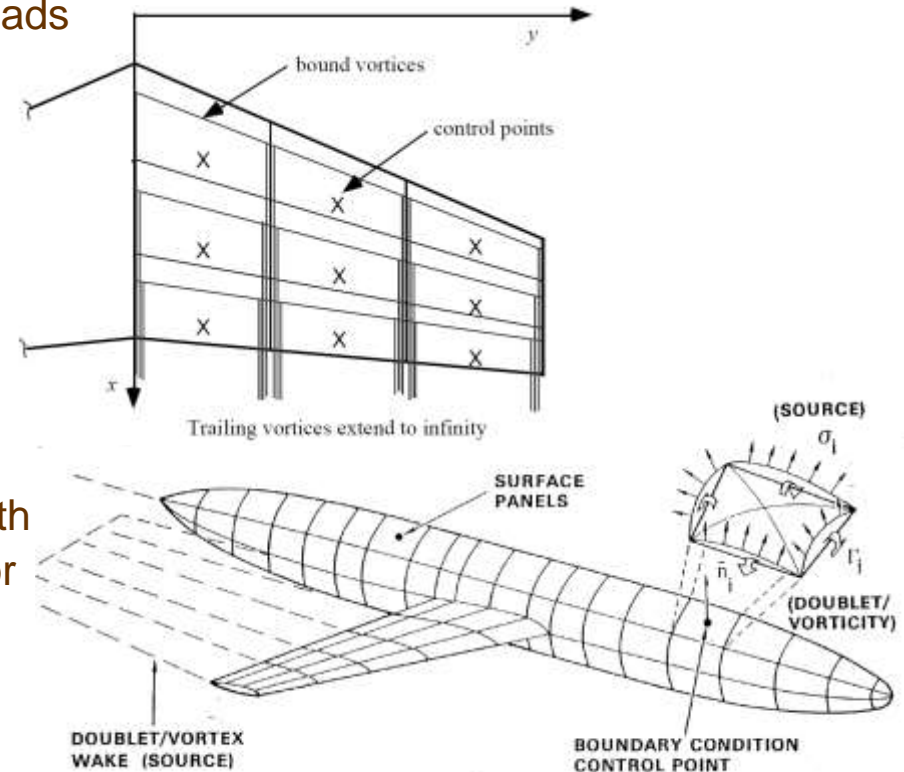

LPMs (VLMs & Panel Methods): Today's Workhorse!

Birth of Vortex Lattice Methods

1940s

- **Falkner (1949) “The Scope and Accuracy of Vortex Lattice Theory,” Report & Memoranda 2740, Aeronautical Research Council**
 - Research motivated by the need to calculate loading distribution on a wing of arbitrary plan form including wing twist, discontinuities due to flaps, compressibility, etc.
 - Outlines principles for solving potential flow problems in lifting plane theory by using a vortex lattice; highlights key developments from Falkner’s R&M 2591 (1947) and R&M 1910 (1943)

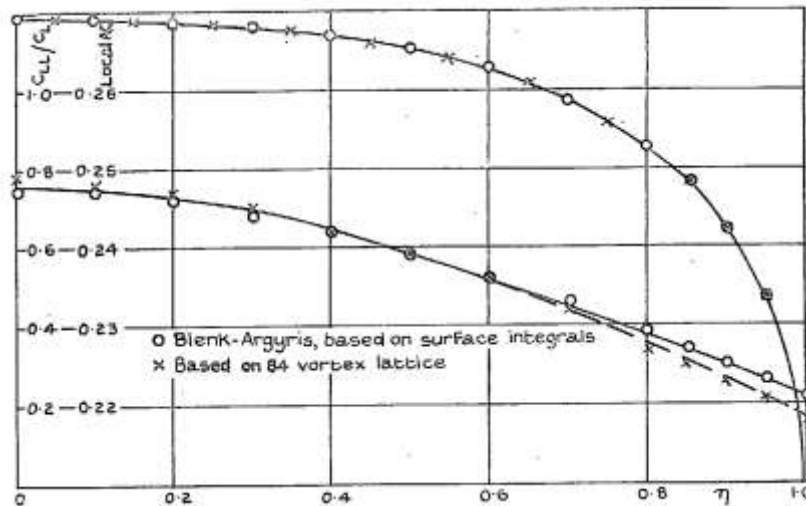

Thin Rectangular Wing: $\Lambda = 0^\circ$, AR = 6
84 vortex lattice: 14 spanwise, 6 chordwise

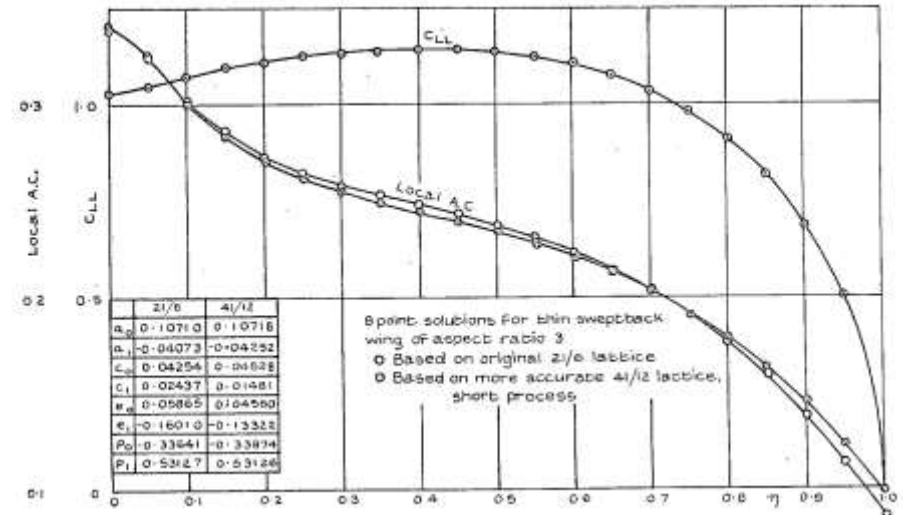

Thin Sweptback Wing: $\Lambda = 45^\circ$, AR = 3
21 spanwise, 6 chordwise and 41 spanwise, 12 chordwise

- **Variations were tried extensively throughout industry during the 1950s**

Advances in Electronic Computers and Numerical Methods in 1960s Made Practical VLM Applications Possible

Vortex Lattice Methods (VLMs)

Rapid Development (1960s & 70s)

- **Rubbert (1964)**
 - Non-planar Vortex Lattice Methods; arbitrary wings—*Boeing Co. Document D6-9244*
- **Margason and Lamar (1971)**
 - Vortex-lattice Fortran program for estimating subsonic aerodynamic characteristics of complex planforms—*NASA TN D-6142*
- **Vortex-Lattice Utilization workshop (1976)**
 - Compilation of many papers—*NASA SP-405*
- **Miranda, Elliott and Baker (1977)**
 - A generalized vortex-lattice (GVL) method for subsonic and *supersonic* flow applications, the VORLAX code—*NASA CR 2865*

**THIN PANEL
LATTICE**

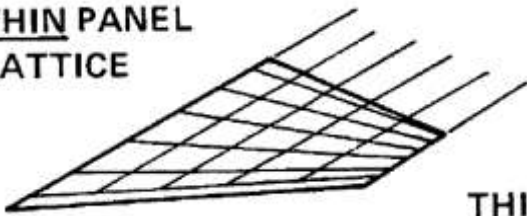

**THICK PANEL
LATTICE**

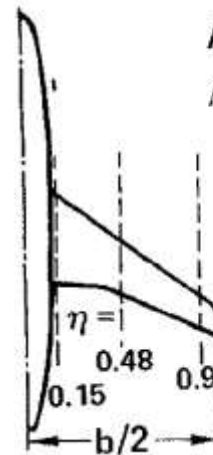
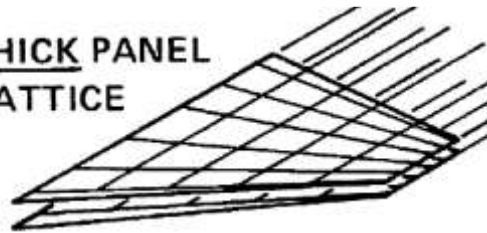

AR = 6.95

$\Delta C/4 = 35^\circ$

$M_\infty = 0.5$

$\alpha = 2^\circ$

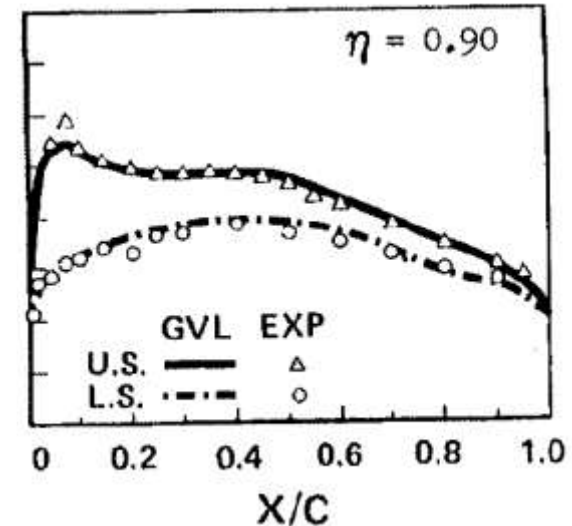

Falkner's Method was Extended and Adapted to Electronic Computers

Birth of Panel Methods

1950s

- **A.M.O. Smith and J. Pierce, Douglas Aircraft Co., Long Beach, CA**
 - Non-circulatory plane [2-D] and axially symmetric flows
 - 1953--Serious work began to solve Neumann problem
 - *Continuous source distribution on surface panels*
 - 1954--Programming on **IBM/701** *in machine language!*
 - Test cases selected based on availability of theoretical [analytical] solutions
 - From 24-point body of revolution solutions in 1954 to **150-points** by the end of 1955!
 - DAC financed all work through **1958**
 - ONR contract: extend the method to 3-D non-lifting flows
- **DAC Report E.S. 26988, April 1958**

A.M.O. Smith



Chief Aerodynamics Engineer, Research
2 July 1911 – 1 May 1997

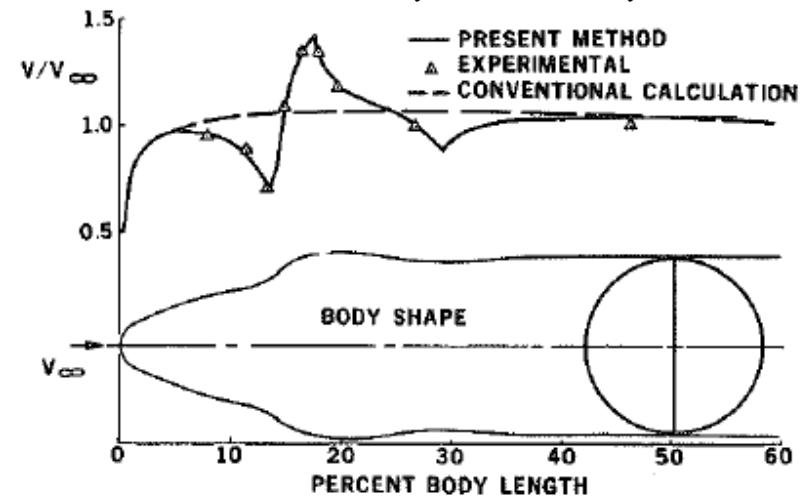

And the Rest is History!

Panel Methods

Rapid Development (1960s & 70s)

- **Hess (1962)**
 - Arbitrary bodies of revolution with axes perpendicular to the free stream direction—*Journal of the Aerospace Sciences*
- **Hess and Smith (1967)**
 - Extensive description of panel methods—*Progress in Aeronautical Sciences, Vol. 8* (138 pages!)
- **Rubbert and Saaris (1968)**
 - Incompressible flow; arbitrary configurations; source and doublet distributions—Fan-in-wing simulation, *SAE Paper 680304*
- **Hess (1970)**
 - Arbitrary 3-D lifting bodies—*McDonnell Douglas Rept. MDC J0971-01* (Also in *Comp. Methods in Applied Mechanics and Engineering, 1974*)
- **Woodward (1973)**
 - Subsonic or *supersonic* flow; wing-body-tail configurations; source and vortex distributions—*NASA CR-2228*

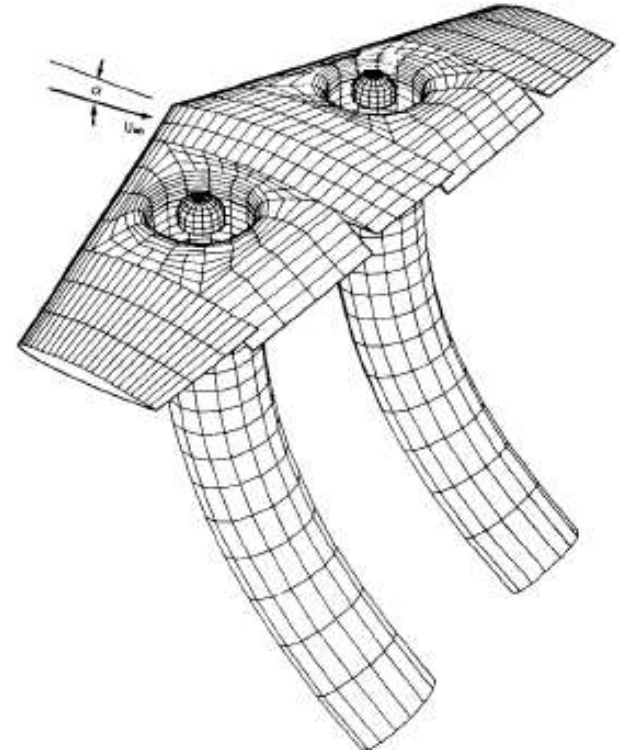

Panels for a fan-in-wing configuration

Offer Powerful Capability to Simulate Flow About Realistic Geometries to Support Aircraft Design Needs

Panel Methods

Technology Comes of Age (1980s)

- **PANAIR (Boeing):** Magnus, Ehlers and Epton—NASA CR 3251, April 1980
 - Subsonic or supersonic flow; arbitrary bodies; higher order singularity distribution
- **MCAIR (McDonnell):** Bristow and Hawk—NASA CR 3528, March 1982
 - Subsonic flow; arbitrary bodies; constant source, quadratic doublet singularities
- **VSAERO (AMI):** Maskew—NASA CR 166476, Dec 1982
 - Subsonic flow; arbitrary bodies; piecewise constant doublet and source singularities
- **QUADPAN (Lockheed):** Youngren, Bouchard, Coopersmith, and Miranda—AIAA 83-1827, July 1983
 - QUADriletral PANel code: subsonic flow; arbitrary bodies; low-order constant sources and doublet singularities

Wing-Body-Canard Analysis

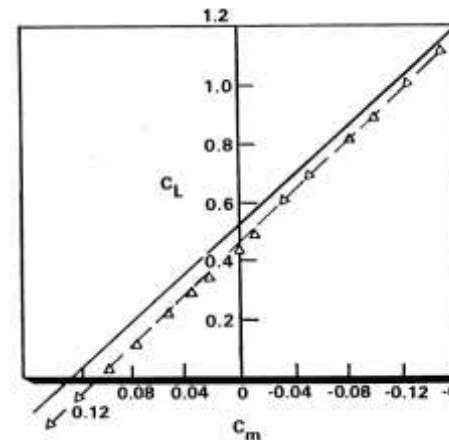
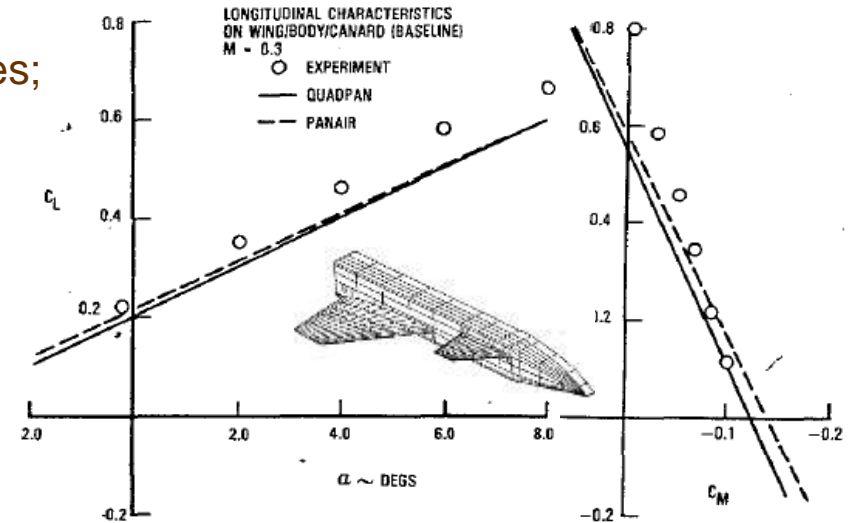

P-3 AEW&C Development

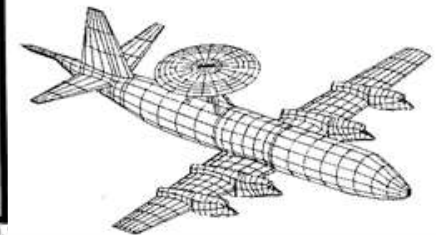

Applicable to Simulate Entirely Subsonic or Supersonic Attached Flows on Full Aircraft Configurations

Limitations of LPM's Applicability

Example 1: Symmetric and Cambered Airfoils Flow Simulation

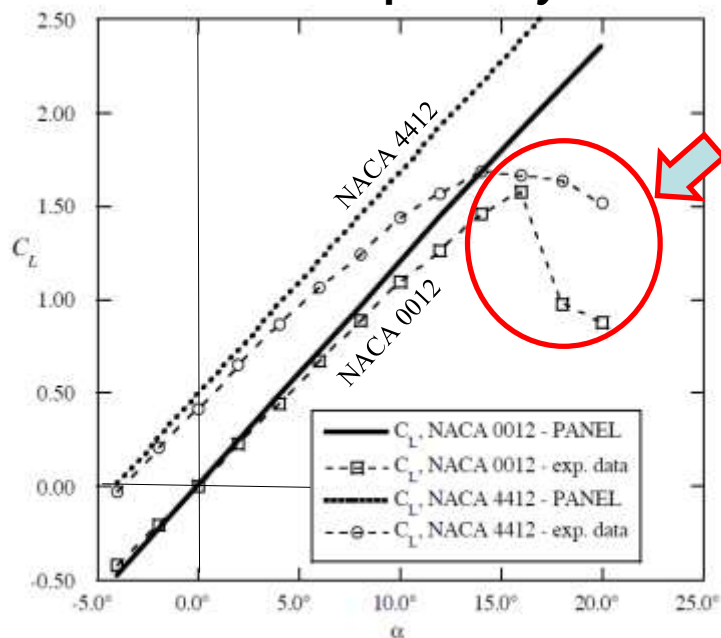

Boundary-layer separation

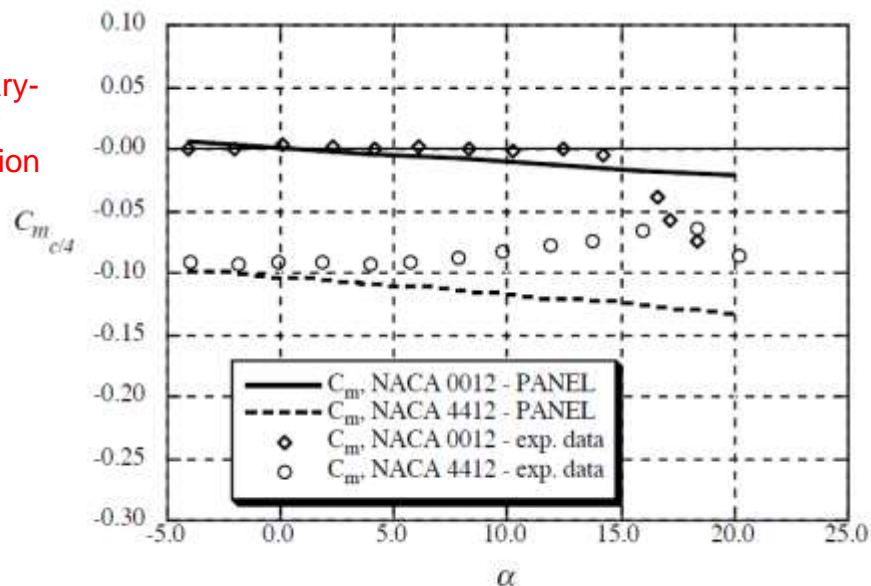

Example 2: Delta Wing Flow Simulation

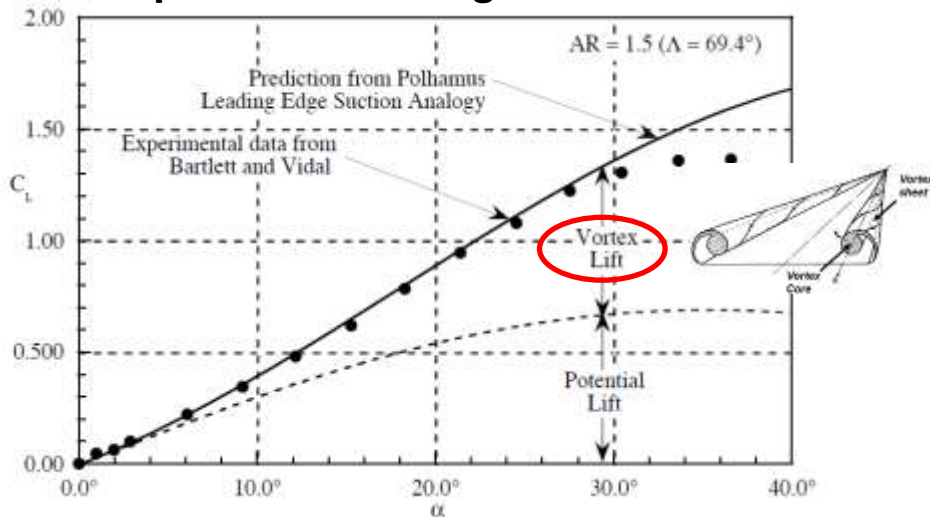

LPMs Applicable for

- *attached* flows that are entirely subsonic or supersonic; not transonic
- flows not dominated by shocks, vortices, or boundary-layer separation

Assessment Based on Comparing LPM Results With Experimental Data!

“Higher, Faster, Farther” Jet Transports

US SST (Supersonic Transport) Aircraft (1960s)

- **June 5, 1963:** FAA launched the SST program to *improve upon the Anglo-French Concorde* with quite aggressive targets
 - 250 passengers
 - $M_{\text{cruise}} = 2.7 - 3.0$
 - 4,000 miles Range
- **January 15, 1964:** Proposals submitted
 - Boeing and Lockheed entries downselected for further development
 - Boeing developed swing-wing B 2707, and Lockheed’s L-2000
- **January 1, 1967:** Boeing won the competition
- **May 20, 1971:** Development work stopped; US Congress canceled funding
 - Rising costs and lack of a clear market were likely factors



SST Design Needs Stimulated Research in Many Areas

“Computer-Aided Aerodynamics”

Utilize Computers to Meet SST Aerodynamic Design Needs (1960s)

- **Wave Drag Analysis–Harris (1964)**
 - Analysis and correlation of aircraft wave drag—*NASA TM X-947*
- **Supersonic Aircraft Design Integration –Baals et al (1968)**
 - Aerodynamic design integration of supersonic aircraft—*AIAA Paper 68-1018*; also in *Journal of Aircraft*, 7(5), 1970

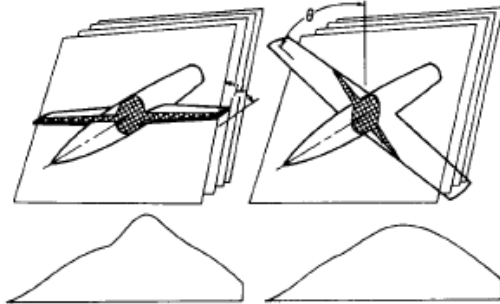

$$D(\theta) = -\frac{\rho V^2}{4\pi} \int_0^1 A''(x_1) A''(x_2) \text{LOG} |x_1 - x_2| dx_1 dx_2$$

$$D = \frac{1}{2\pi} \int_0^{2\pi} D(\theta) d\theta$$

- **Supersonic Wing Camber Design – Carlson and Middleton (1964)**
 - Numerical method for designing camber surfaces of supersonic wings with arbitrary planform corresponding to specified load distributions—*NASA TN D-2341*

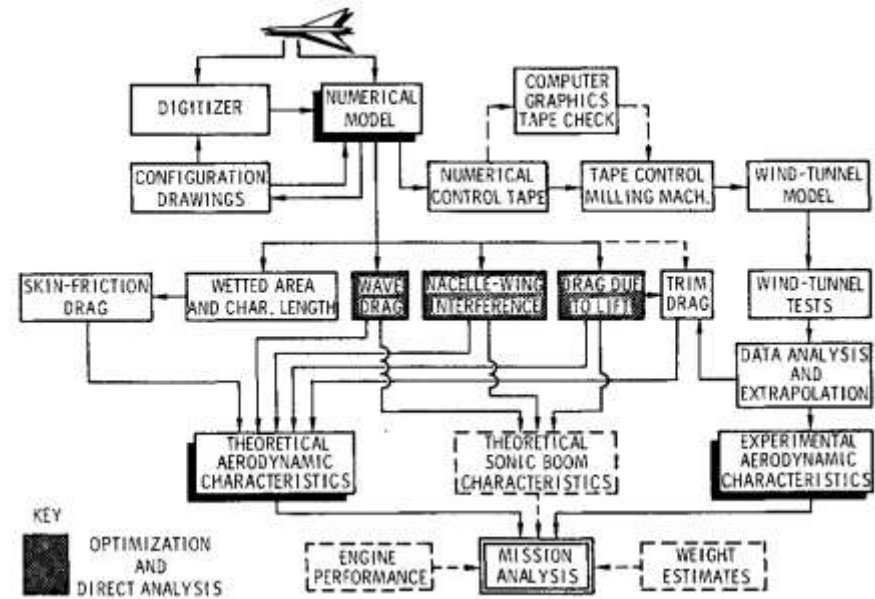

Key operational Langley computer programs for estimating aerodynamic characteristics of a numerical model of the configuration for mission performance analysis

“Computer-Aided Aerodynamics” Demonstrated Its Usefulness

“Higher, Faster, Farther” Jet Transports Transonic Aircraft (1960s)

- Jet transport designs in the 1960s pushed cruise speed into transonic regime to maximize Range Factor, $M_{cruise} (L/D)$
 - C-5A (1968): $M_{cruise} = 0.77$
 - B747 (1969): $M_{cruise} = 0.84 - 0.88$
 - L-1011 (1970): $M_{cruise} = 0.86$
- Drag rises with speed due to added wave drag + shock-induced separation drag
 - *The higher the drag rise Mach number, the better!*
 - Sweep helps...but design tradeoffs limit it to about 35° in practice



LPMs of Little Use for Accurate Transonic Flow Simulation

Transonic Aircraft Design

EFD: Primary Means of Flow Simulation

- **Whitcomb (1954 Collier Trophy)**

- “Area Rule”

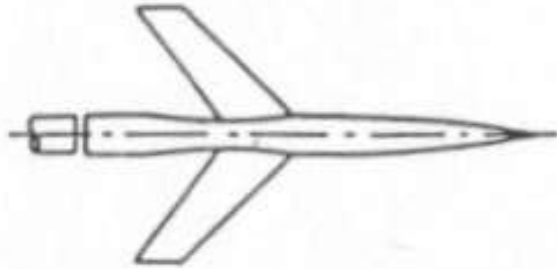

- **Pearcy (1962)**

- “Peaky” airfoils: 0.02 to 0.03 increase in drag rise Mach number over NACA 6-series

- **Whitcomb (1967)**

- Supercritical “roof top” airfoils

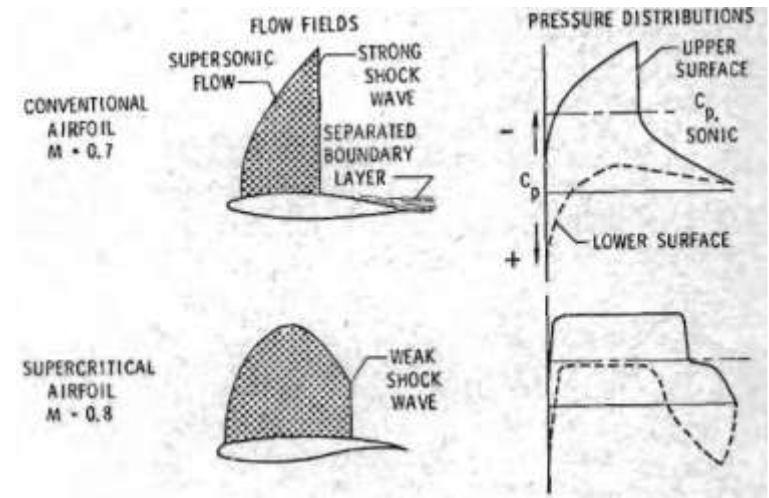

ACA Capability Urgently Needed to Support Design Needs!

Level II

Nonlinear Potential Methods

1970s - present

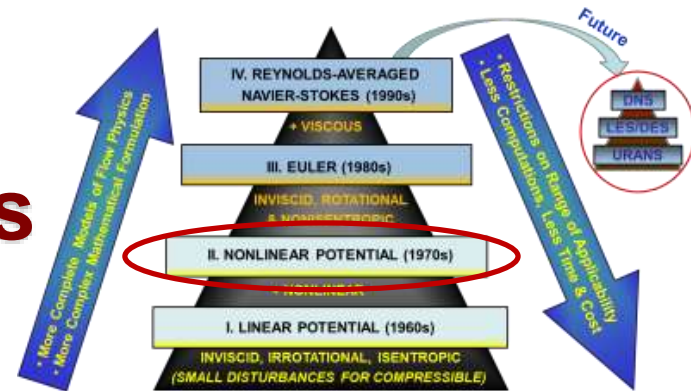

Flow Model

- Inviscid, Irrotational, Isentropic

$$\mathbf{U} = (u, v, w) = \nabla \Phi$$

$$\Phi_{tt} + 2 \mathbf{U} \cdot \mathbf{U}_t = a^2 \nabla^2 \Phi - \mathbf{U} \cdot \nabla (U^2/2)$$

- ✓ Nonlinear second-order PDEs with appropriate boundary conditions
- ✓ Transonic Small Disturbance (TSD) or Full Potential formulations
 - Mass conserved across discontinuities
 - Momentum deficiency provides an estimate of wave drag
 - *Wakes not captured as part of the solution—must be explicitly modeled*

Applicability

- Transonic flows with weak shocks
- Flows with no distributed vorticity and/or boundary-layer separation

Birth of Nonlinear Potential Methods

1970s

Murman and Cole (1970)

- **Landmark paper** AIAA 70-188, Jan 1970; *published in the AIAA Journal*, 9 (1), 1971
- **Mixed finite difference scheme** for perturbation potential equation of plane steady transonic flow; *requires meshing a domain surrounding the geometry*

Earl Murman



Hon Fellow AIAA
Boeing, Flow Research, NASA
MIT Professor Emeritus
Born: 12 May 1942

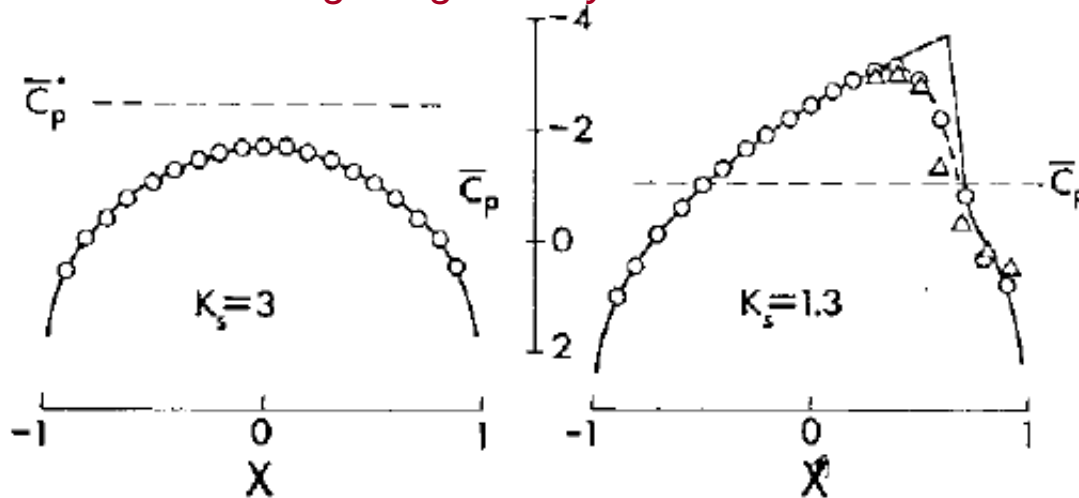

— Present Computations

○ $Re_c \approx 2 \times 10^6$

△ $Re_c \approx 2 \times 10^6$ (L.E. Roughness)

Experiments
Knechtel - Ames
 $\delta = .06$

$K_s = (1 - M_\infty^2) / (M_\infty^2 \delta)^{2/3}$ Transonic similarity parameter after Spreiter

Circular Arc Airfoil

- 74x41 mesh points
- 400 iterations
- **30 minutes on IBM 360/44**

“Supersonic zone and shock waves appear naturally in the course of the solution.”

Transonic Small Disturbance (TSD) Equations Methods for Wing and Wing-Fuselage Configurations

- **Bailey and Ballhaus (1975)**

- Good comparisons of computed and measured pressures for transonic flows on wing and wing-fuselage configurations—*NASA SP-347*

- **Boppe (1978)**

- Transonic flow about realistic aircraft configurations—*AIAA Paper 78-104, 1978*

- Finite-difference scheme applied to an improved TSD equation

- ✓ *Unique grid embedding scheme to improve solution accuracy*

- Approx. **45 minutes on IBM 370**
(15 mins. on CYBER 175)

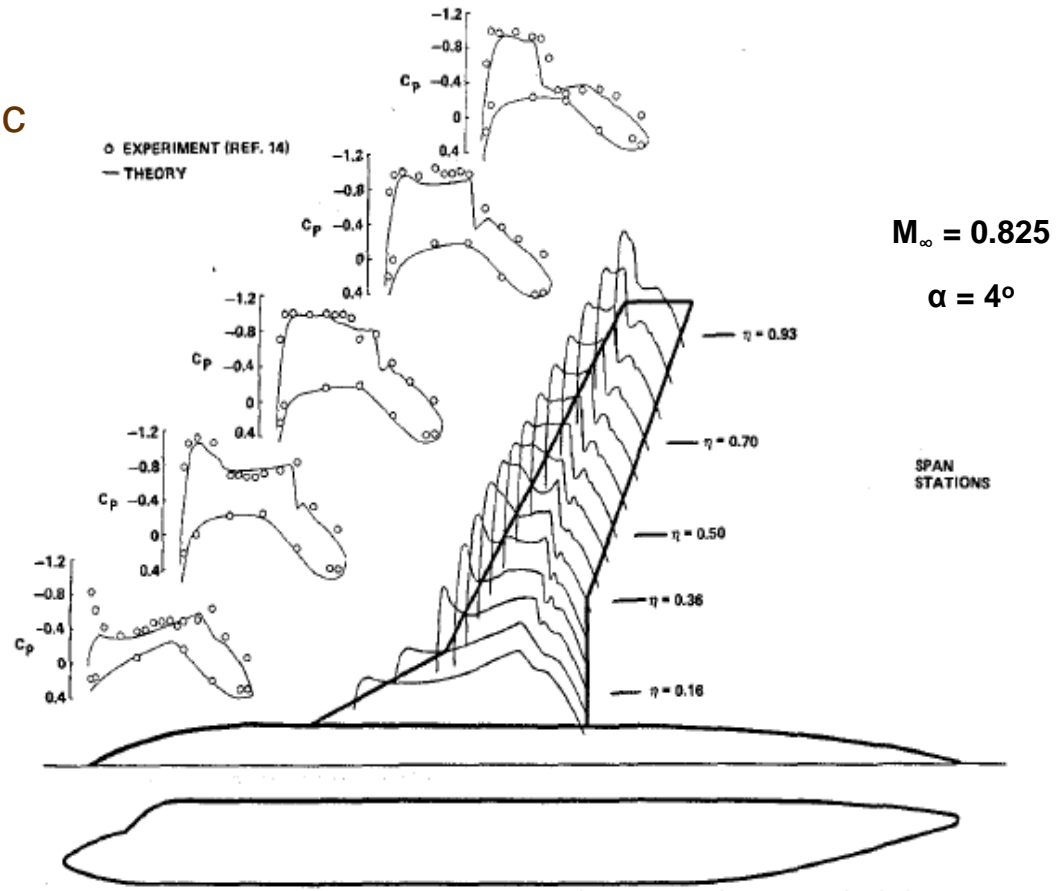

A New Transonic Aerodynamic Analysis and Design Capability!

Transonic Full Potential Equations (FPE)

A Method for Swept Wings

Jameson and Caughey (1976)

- **FLO 22: 3-D swept wings**
 - ✓ Full Potential Equations transformed into sheared parabolic coordinates
 - ✓ Solved using Jameson's coordinate invariant *rotated difference scheme*
- **Final Mesh:** 192x24x32 cells; 100 relaxation sweeps; 85 minutes CPU time on CDC 6600

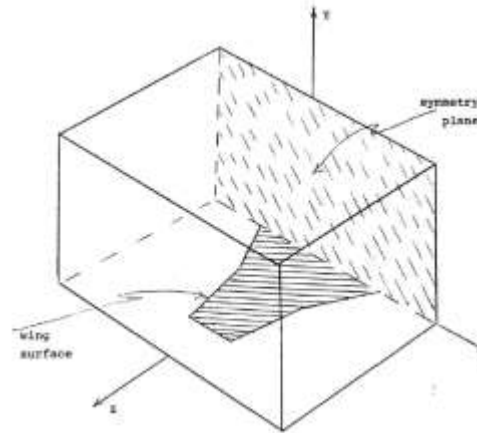

Antony Jameson

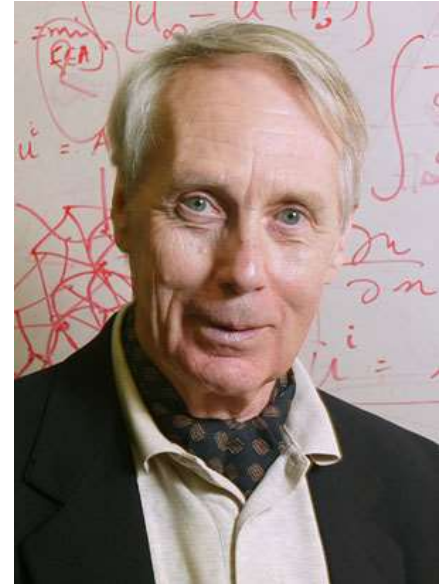

FRS, Hon Fellow AIAA,
Foreign Member NAE
*'Father of FLO & SYN
Series of CFD Codes'*
Hawker Siddeley, Grumman
NYU, Princeton, Stanford,
Texas A&M
Born: 20 Nov 1934

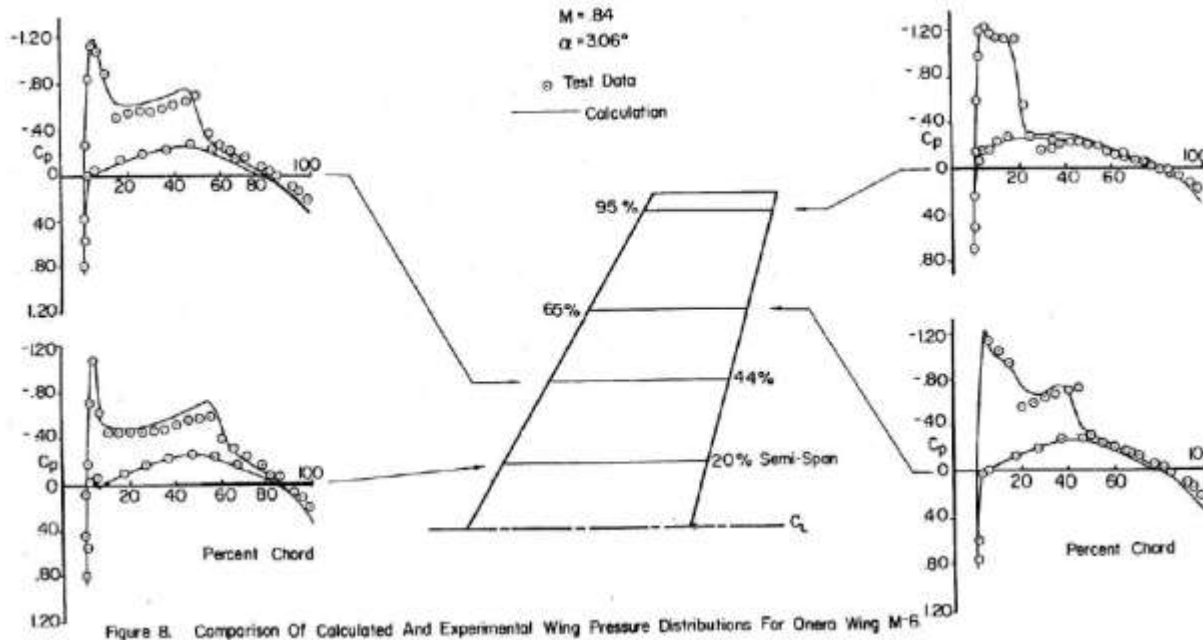

- **Theory, Results, and Computer Program** in *ERDA Research and Development Report, COO-3077-140, 1977*

Transonic Full Potential Equations

A Method for Wing-Body Combinations

Caughey and Jameson (1980)

- **FLO 28 & FLO 30**: transonic flow past **wing-body combinations** using **finite-volume method** on boundary conforming grids—*AIAA J*, 18(11), 1980
 - **FLO-28**: Fully conservative difference scheme in the Joukowski/parabolic coordinate system.
 - **FLO-30**: Fully conservative difference scheme in the cylindrical/wind-tunnel coordinate system.

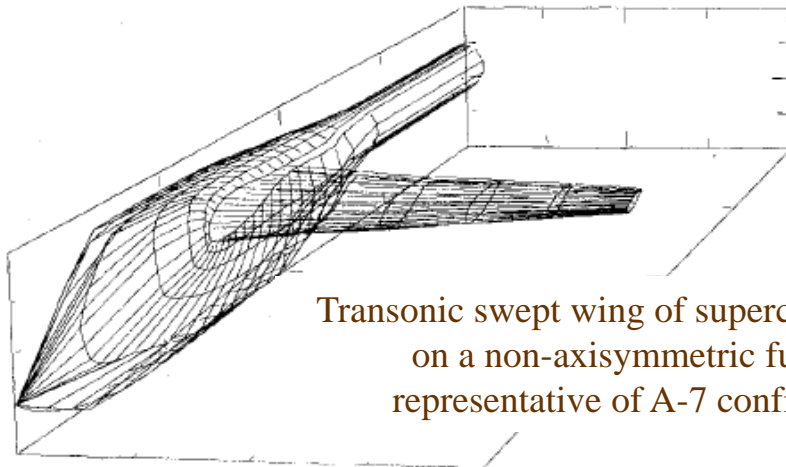

Transonic swept wing of supercritical section
on a non-axisymmetric fuselage,
representative of A-7 configuration

- Three-mesh sequence; coarsest mesh: 40x6x8 cells; finest mesh: 160x24x32 cells
- 200 iterations on two coarse meshes; 100 on finest mesh
- **35 minutes of CPU time on CDC 7600**

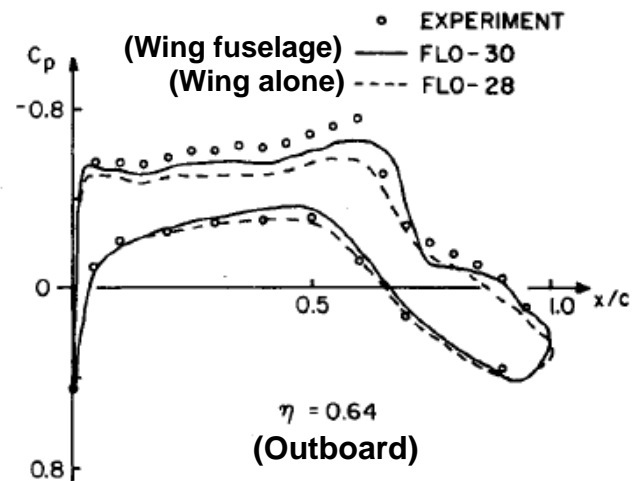
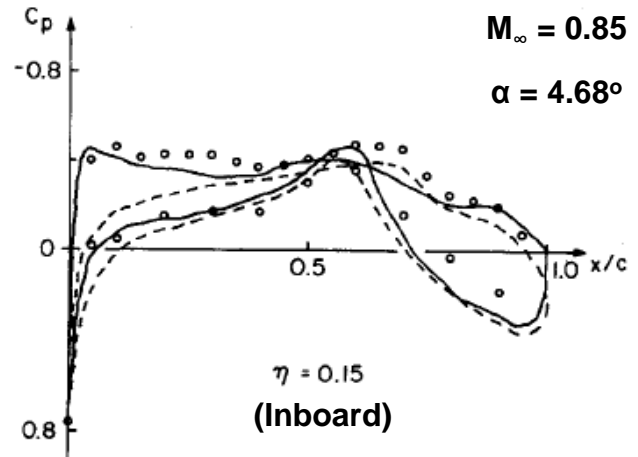

Limitations of Potential Flow Methods

Implications of Neglecting Viscosity

- Potential Flow Methods, Linear and Nonlinear, *Being Inherently Inviscid*, Cannot Capture Effect of Viscosity on the Flow Field

- *Particularly problematic for transonic flows*

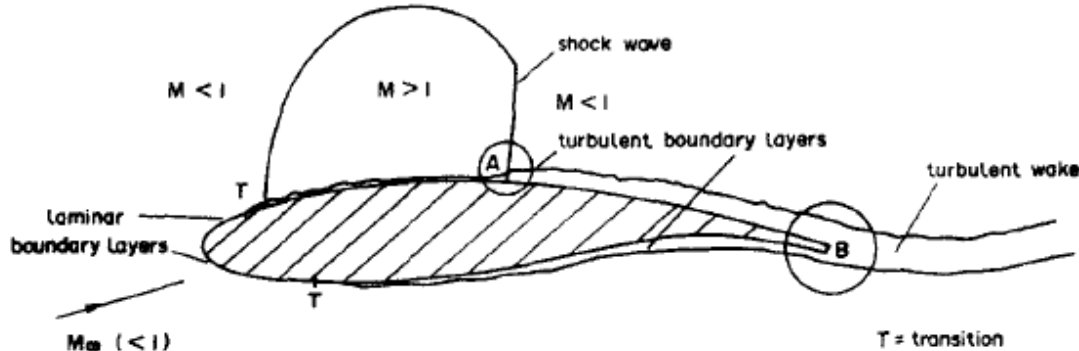

- 1970s: Two Viscous-Inviscid Interaction Schemes Developed to Simulate Effects of Viscosity

1. Add boundary-layer (B.L.) displacement thickness, δ , to configuration surface and compute potential flow on the new surface
 - Estimate δ using integral B.L. equations
2. Use transpiration boundary condition on configuration surface to compute potential flow which simulates change in shape due to B.L.
 - *More convenient; no need to regenerate mesh*

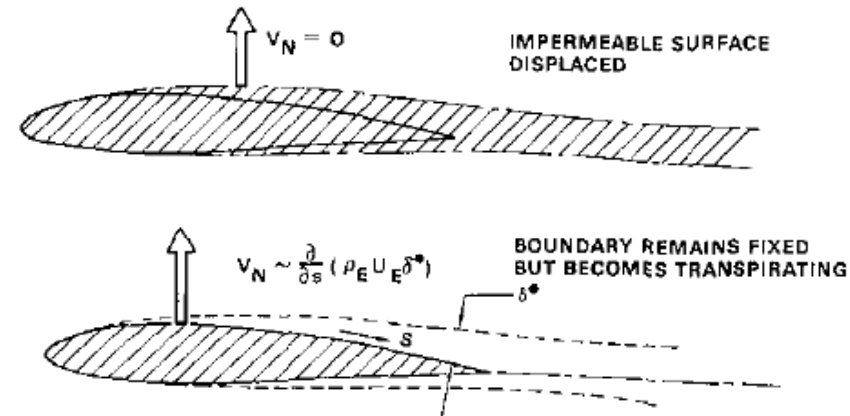
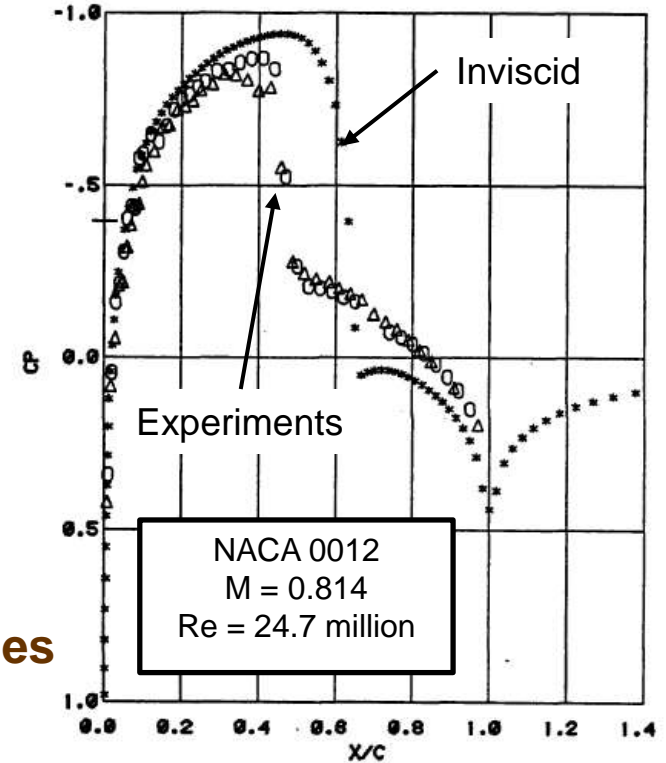

Why Not Use RANS Methods?

They Overcoming Limitations of Potential Flow Methods!

Very Active Area of Research in the 1970s, But Not Many Practical Applications

- **Laminar Flows** (Considered as a special case of RANS with Zero Turbulence!)
 - **MacCormack (1971)**—Pioneering investigation of shock-wave interaction with laminar boundary layer
 - **Carter (1972)**—Supersonic laminar flow over a 2-D compression corner
 - **Li (1974)**—laminar flow separation on blunt flared cones at angle of attack
 - **Tannehill et al. (1976)**—2-D blunt-body flows with impinging shock
 - **Steger and Kutler (1976)**—implicit finite-difference procedures for computation of vortex wakes

Supercritical Airfoil

$M_\infty = 0.75$
 $Re = 21 \times 10^6$

DRAG POLAR

LIFT CURVE

EXPERIMENT (KACPRZYNSKI et al 1971)

○ 22.5% TUNNEL WALL POROSITY
△ 6% TUNNEL WALL POROSITY

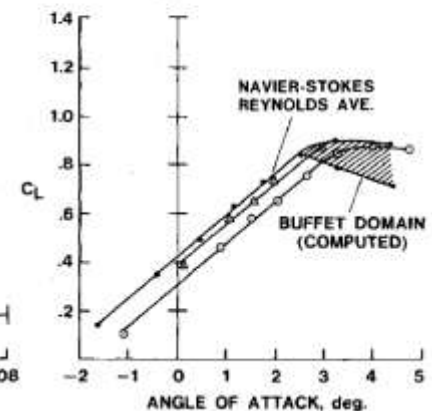
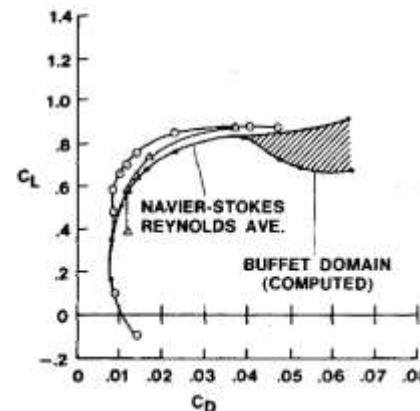

- **Turbulent Flows**

- **Wilcox (1974)**—turbulent boundary-layer shock-wave interaction
- **Deiwert (1974)**—high Reynolds number transonic flow simulation
- **Shang & Hankey (1975)**—supersonic and hypersonic turbulent flows over a compression ramp
- **Deiwert and Bailey (1978)**—computing airfoil aerodynamics with RANS codes

“...RANS approximation...a more youthful stage of development.”
— Dean Chapman, Director of Aeronautics, NASA Ames

Digital Computers:

A Key Enabler for RANS CFD Research in the 1970s

Speed & Cost Trends (1950 to 1975)

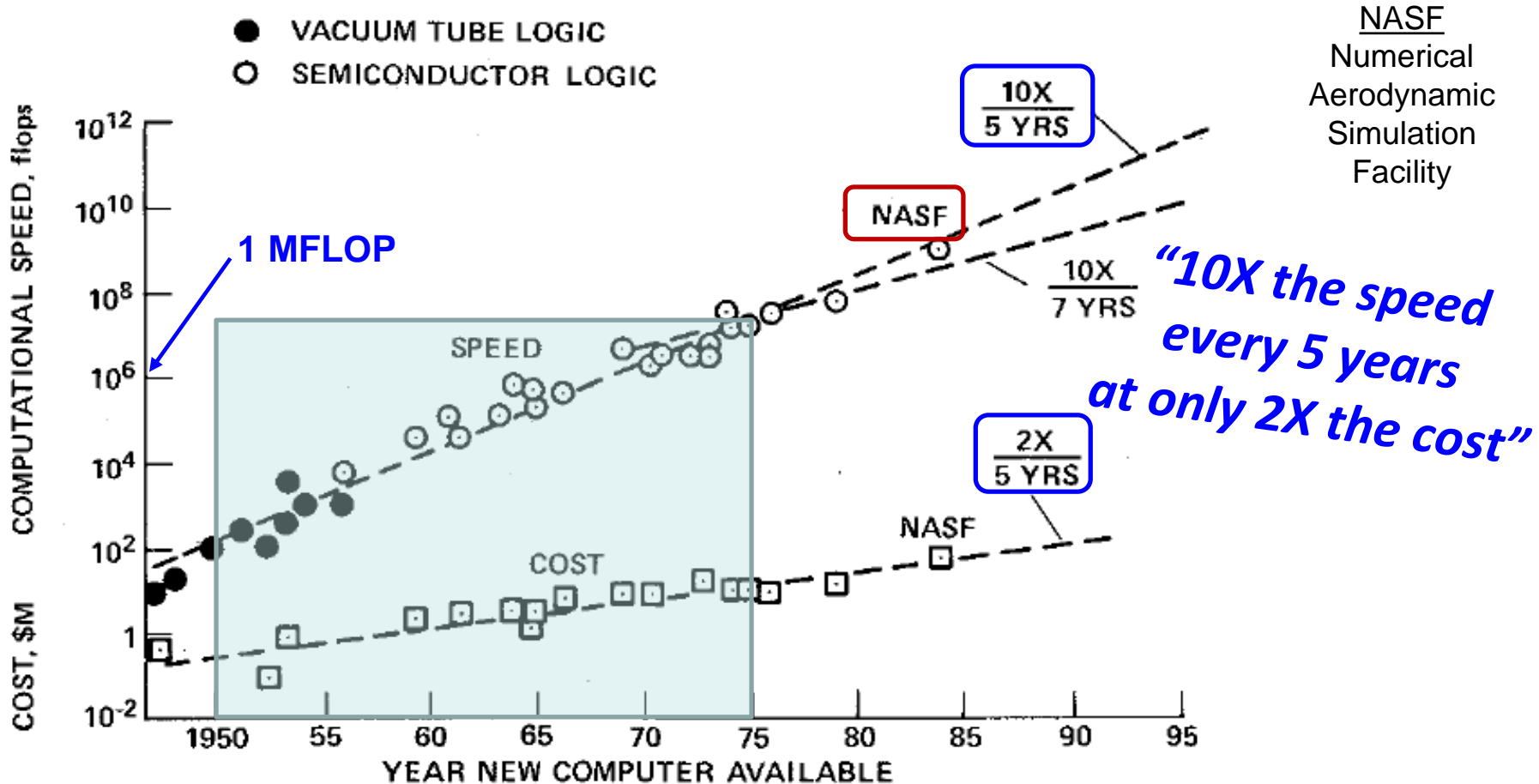

Factoid: early computing speed measure was *kilo-girls*, roughly the calculating ability of a thousand women!

Phenomenal Cost-performance Increase Over 25 Years

Computers vs. Wind Tunnels for Aerodynamic Flow Simulations

DEAN R. CHAPMAN, HANS MARK, and MELVIN W. PIRTLE

NASA Ames Research Center



AIAA Astronautics & Aeronautics

APRIL 1975

VOLUME 13, NO. 4

“...within a decade computers should begin to supplant wind tunnels in the aerodynamic design and testing process...”

“To *displace* wind tunnels as the principal source of flow simulations for aircraft design, computers must reach about 10^4 times the speed of Illiac IV...such computer performance should be available in the mid-1980s, or somewhat later...”

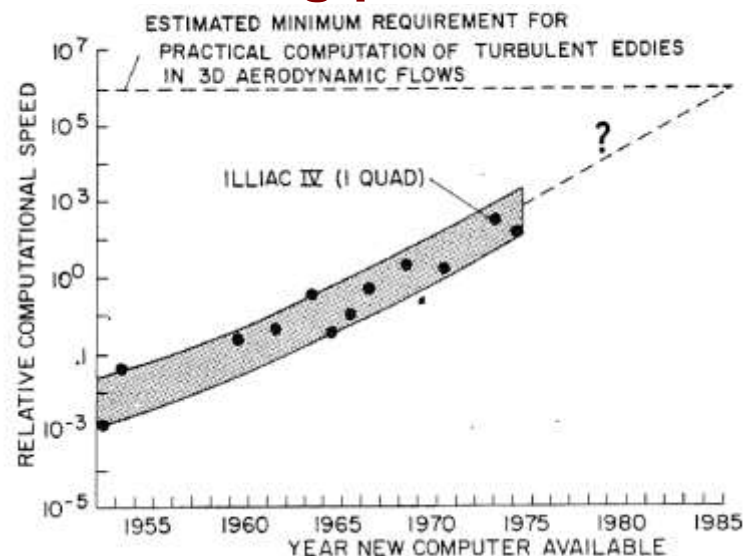

***The Adolescent Years with Irrational Exuberance!
We got caught up in the euphoria of our promising accomplishments***

“Imagining the Future”

Long After CFD Displaces Wind Tunnels!

“The most accurate aerodynamic prediction code available today, FLO-1234.5, is so complex and expensive that it has never been run. Many other codes, if run to completion, would require CPU time exceeding the average human lifespan.”

“Fortunately there is an exciting new technology...Two workers at UNCAF (United Nations Computational Aerodynamics Facility) have recently made a **startling discovery...by building a small wooden model of an airplane and then blowing air past it in an enclosed tunnel, reasonably accurate predictions may be made of what the flow codes would compute.** Also, some factors, such as artificial viscosity (numerical diffusion), are neglected completely in wind tunnel modeling.”

“While the wind tunnel may never fully replace the computer, it is almost certain to become the most useful engineering tool of the future.”

Will the Wind Tunnel Replace the Computer?

By BOB COOPERSMITH

AIAA Student Journal

Summer 1985



Wind Tunnels Are Here To Stay!

Symbiosis: Why CFD and wind tunnels need each other

By JOE STUMPE

AIAA Aerospace America

JUNE 2018

As powerful as **computational fluid dynamics** and supercomputing are, they have **not come close to relegating wind tunnels to history**. In fact, in the U.S., a new tunnel is going up at MIT, and NASA is deliberating whether it should close a historic tunnel at NASA's Langley Research Center in Virginia four years from now as planned.

Computers Have Failed to Supplant W/Ts Defying Experts!

While the World of CFD Was Exploding in '50s & '60s ...a lad was growing up* completely oblivious to it all!

1950s (Foundational Years)

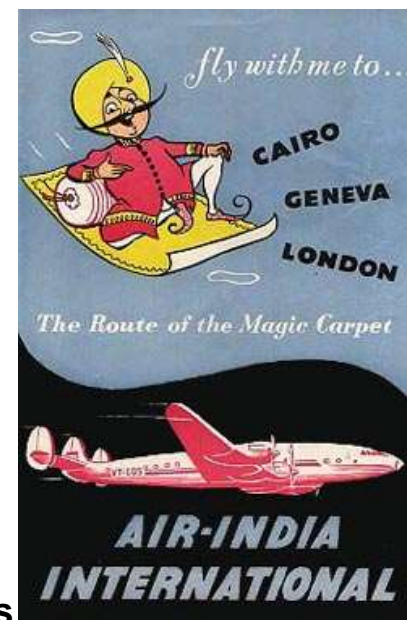

Early 1950s

1960s (Formative Years)

- 1963 **High School** (10th grade): Government Higher Secondary School Muzaffarnagar, U.P., India (*1st division; distinction in English, Mathematics, Science and Sanskrit; ranked 15th in statewide exam*)
- 1965 **Intermediate College** (12th grade): S.D. Intermediate College, Muzaffarnagar, U.P., India (*1st division; distinction in Physics, Chemistry and Mathematics; ranked 7th in statewide exams; too young for IIT*)
- 1967 **Bachelor of Science**: S.D. College, Muzaffarnagar, U.P., India; College affiliation—Agra University, now Meerut University (*1st division; distinction in Physics, Chemistry, and Math; graduated at the top of the class; Chancellor's Medal*)
- 1970 **Bachelor of Engineering** (with Distinction), **Electrical Technology**
Indian Institute of Science, Bangalore, India (*graduated at the top of the class; recipient of Hay medal*)



1970s (Young Adult Years)

1970 - 1972

- **Master of Engineering** (with Distinction), **Aeronautical Engineering**
Indian Institute of Science, Bangalore, India
- Advisor: **Dr. Suresh M. Deshpande**
- Project: *Numerical Determination of Periodic Solutions for Gravity Gradient Stabilized Satellites*
 - **First exposure to FORTRAN for computer programs/codes**
 - ✓ Integrated two coupled 1st order ODEs
 - ✓ Used **IBM 360/44** for processing

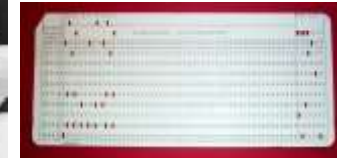

1972 - 1976

- **Ph.D., Aerospace Engineering**
Georgia Institute of Technology, Atlanta, Georgia, USA
- Advisor: **Dr. Robin B. Gray**
- Dissertation: *A Method of Computing the Potential Flow on Thick Wing Tips*
 - Developed **LPM** using **surface vorticity distribution**
 - ✓ Vorticity strength determined using iterative procedure; avoided inverting large ill-conditioned matrices
 - ✓ **CDC Cyber 70/74** NOS 1.1-419/420
 - 2-D results in *AIAA Journal of Aircraft*, 15 (10), 1978
 - 3-D results in *Journal of Aircraft*, 16 (3), 1979



Entrée into the “World of CFD”!

1976 - 1978

- **Research Assistant Professor**, Aerospace Engineering, Iowa State University, Ames, Iowa
- NASA-Ames sponsored project: *Alleviation of wake-vortex hazard through merging of co-rotational vortices*
- Principal Investigator: **Dr. James D. Iversen**
- Raj conducted computational investigations to complement experimental research of **Steve Brandt**
 - ✓ *Wonderful memories of working with, and learning from, **Dr. Joseph L. Steger**—a CFD pioneer, a professional, and a gentleman—at NASA-Ames Research Center*
 - ✓ *Experienced the challenge of simulating vortical flows using zero, one, and two equation turbulence models in Steger & Kutler’s implicit finite-difference procedure for computation of vortex wakes*



Joseph L. Steger



CFD Pioneer
NASA Ames, Stanford,
Univ. of California-Davis
(1944-1992)

1978 - 1979

- **Assistant Professor**, University of Missouri-Rolla
- **Taught Undergraduate courses:** Fluid Mechanics, Thermodynamics, and Heat Transfer



1979

- **Sr. Aerodynamics Engineer**, Computational Aerodynamics Group, Lockheed-California Co., Burbank, California
- Group Engineer: **Mr. Luis R. Miranda**



First Day on the Job: May 1979

Dr. A. Richard Seebass (University of Arizona, Tucson) visits Lockheed in Burbank!

- Raj assigned to work with Dick Seebass on **shock-free supercritical wing design** procedure using **fictitious gas concept** [motivation: wing design for future L-1011-500 aircraft]
- Results using **FLO-22** in *AIAA Paper 81-0383*; also in *AIAA Journal of Aircraft*, 19(4), 1982

A. Richard Seebass



Renowned Aerodynamicist and Educator (1936-2000)

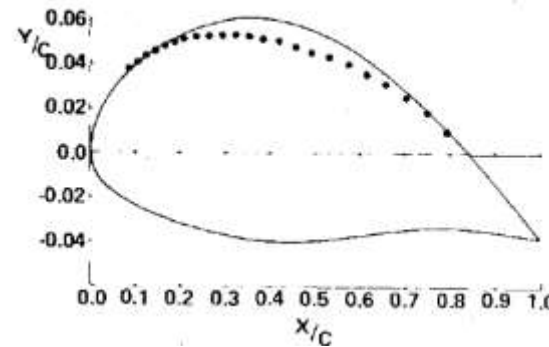
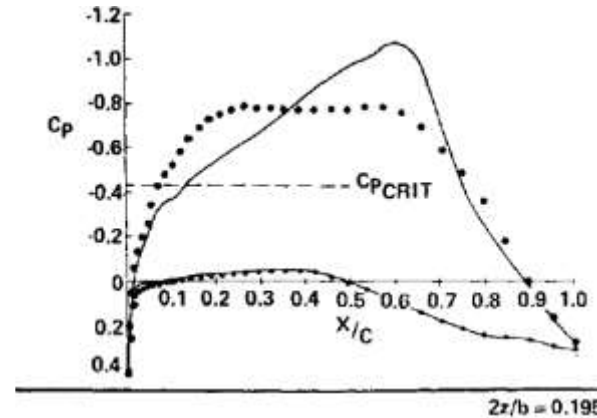
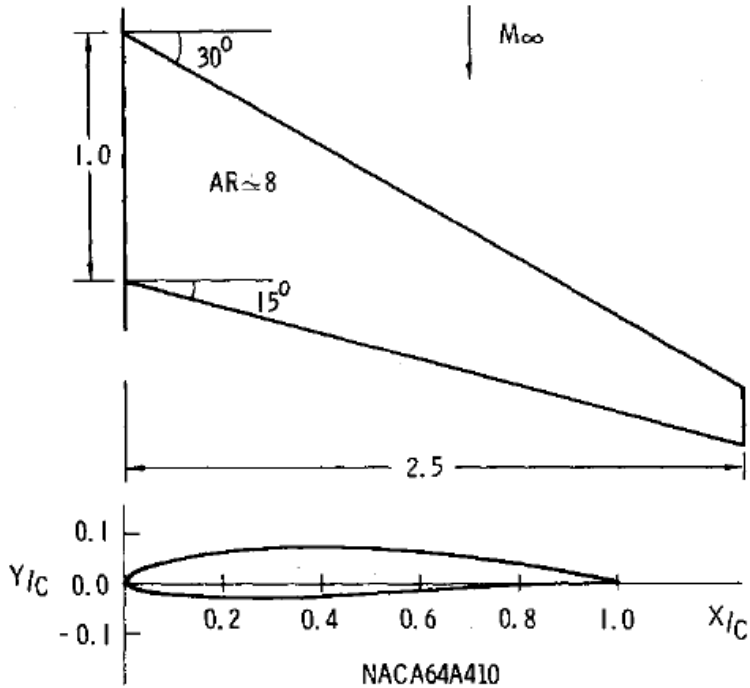

$M_\infty = 0.8$

$C_L = 0.63$

Inviscid Drag reduced by ~35%

Overnight Immersion into Transonic Aerodynamics!

The Strange Seventies!

- **“The Lockheed Debacle”**
 - 1969-71: C-5 Galaxy cost overruns and serious wing design issues
 - 1971: Saved from bankruptcy by U.S. Congress approval of \$250 million ‘Loan Guarantee’
 - 1974: Stock Price drops to a **Low of 33/8** (High of 737/8 in 1967!)
 - 1976: Foreign Bribery Scandals cost \$1.3 Billion order to Japan
- **Rolls-Royce Bankruptcy**
 - 1971: Could not proceed with RB-211 engine for Lockheed’s L-1011 Tristar
 - Cost of each engine increased by 30% over fixed-price contract estimate
 - Additional \$360 million required to put the new engine into production
- **“The Great Boeing Bust”**
 - **Business**
 - 1969: Introduced now iconic B747
 - 1970-71: Not a single new order from any U.S. airline for 17 months
 - 1971: SST program cancelled by U.S. Government
 - **Workforce**
 - 32,500 employees by late 1971—down from about 80,000 in 1969
 - *“Optimists brought lunch to work, pessimists left the car running in the parking lot”*
- **Few Exciting Endeavors!**
 - 1970: Pan Am 747 NY–London service
 - 1970: First operational C-5A Galaxy
 - 1975: New starts: GD F-16 and MDC F/A-18
 - 1976: Concorde entered service



Computational Aerodynamics Outlook At the End of the 1970s

Computational Aerodynamics Development and Outlook

DEAN R. CHAPMAN, Director of Aeronautics,
NASA Ames Research Center, Moffett Field, California

AIAA Journal, Vol 17, No.12, Dec 1979
"AIAA Dryden Lectureship in Research"



Prof. Emeritus Stanford University
8 Mar 1922 – 4 Oct 1995

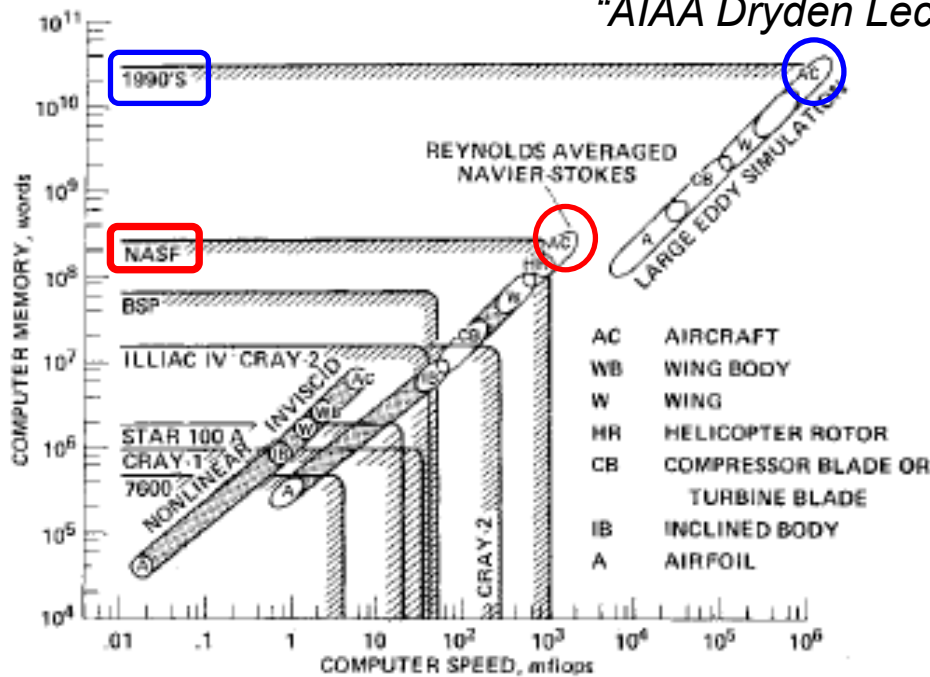

Computer requirements for steady-flow simulation: 1-hour run using 1978 algorithms

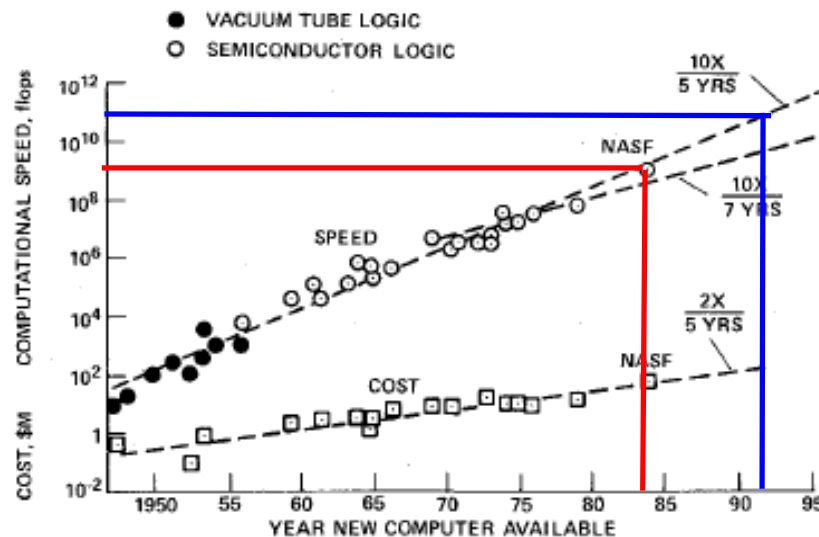

Outlook didn't quite pan out!

It's difficult to make predictions, especially about the future. – Anon.

Section 5.1: Key Takeaways (1 of 2)

- **ACA evolution paced by dramatic advances in CFD since the 1950s**

- Four levels of CFD methods, each based on approximations of Navier-Stokes equations
 - *Level I*: inviscid, irrotational, isentropic flows using linearized potential flow equations
 - *Level II*: inviscid, irrotational, isentropic flows using nonlinear potential flow equations
 - *Level III*: inviscid Euler equations
 - *Level IV*: viscous RANS equations

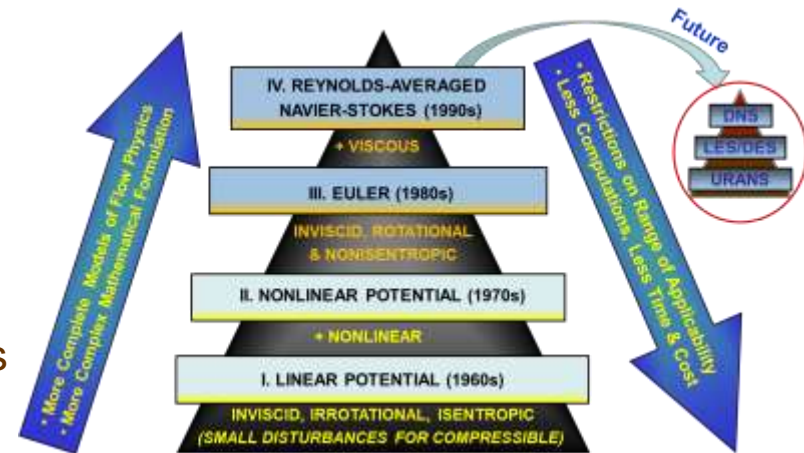

- **1950s: Birth of Linear Potential Methods (LPMs)**

- Vortex Lattice Method (VLM) and Surface Panel Method
- Technology comes of age in the 1980s—Today’s workhorse for early stages of design
- Range of applicability limited to purely subsonic or supersonic attached flows

- **1960s: Supersonic Aircraft Design Needs motivated development and demonstration of “Computer-aided Aerodynamics” and its usefulness**

- Harris Wave Drag analysis, and aerodynamic design process integration

- **1960s: Transonic Aircraft Design Needs—LPMs woefully inadequate**

- EFD enables peaky airfoils; Area Rule and Supercritical airfoils

- **1970s: Birth of Nonlinear Potential Methods (NPMs)**

- Transonic Small Disturbance (TSD) and Full Potential Equation (FPE) Methods
- *“Supersonic zone and shock waves appear naturally in the course of the solution.”*

Section 5.1: Key Takeaways (2 of 2)

- **1970s: Implications of Neglecting Viscosity in LPMs & NPMs Addressed**
 - Simulation of viscous effects
 - ✓ *Inviscid Potential Flow methods*: Viscous-Inviscid Interaction
 - Direct addition of boundary-layer displacement thickness
 - Transpiration boundary condition
 - ✓ *RANS methods*
 - Active area of research—algorithm development and mostly 2-D applications
 - “...youthful stage of development”
 - Phenomenal advancements in digital computers
 - ✓ 10x the speed every 5 years at only 2X the cost!
- **Mid-1970s: “Adolescent Years with Irrational Exuberance” for CFD**
 - “To displace wind tunnels as the principal source of flow simulations for aircraft design... the required computer capability would be available in the mid-1980s.” “...within a decade computers should begin to *supplant* wind tunnels in the aerodynamic design and testing...”
- **Late 1970s: Author got great opportunities to work with CFD pioneers who were excellent mentors; and then joined the ranks of budding “CFDers”**
- **1979: My ‘First Day on the Job’ at Lockheed**
 - Computational analysis and design of configurations in transonic flows
 - “It’s about serving the most pressing need of your employer, not about what one might or might not want to do”
 - “Your ability to learn, and not just what you know, is a key differentiator”
- **CFD Outlook at the End of the Seventies**
 - Full aircraft steady simulation in one hour in the 1990s using LES and 1978 algorithms!

BIBLIOGRAPHY

SECTION 5

5. Evolution of Applied Computational Aerodynamics (1950-2000)

5.1 Infancy through Adolescence (1950–1980)

- 5.1.1 Falkner, V.M., “The Scope and Accuracy of Vortex Lattice Theory,” R & M No. 2740, A.R.C. Technical Report, 1949.
- 5.1.2 Rubbert, P.E., “Theoretical Characteristics of Arbitrary Wings by a Nonplanar Vortex Lattice Method,” Boeing Report D6-9244, The Boeing Company, 1964.
- 5.1.3 Margason, R.J. and Lamar, J.E., “Vortex-Lattice FORTRAN Program for Estimating Subsonic Aerodynamic Characteristics of Complex Planforms,” NASA TN D-6142, 1971.
- 5.1.4 “Vortex Lattice Utilization,” NASA SP-405, May 1976.
- 5.1.5 Miranda, L.R., Elliott, R.D., and Baker, W.M., “A Generalized Vortex Lattice Method for Subsonic and Supersonic Flow Applications,” NASA CR-2865, 1977.
- 5.1.6 Smith, A.M.O., “The Panel Method: Its Original Development,” Chapter 1, Applied Computational Aerodynamics, Progress in Astronautics and Aeronautics, Vol. 125, AIAA, Washington D.C., 1990, Henne, P.A. (Editor).
- 5.1.7 https://en.wikipedia.org/wiki/Apollo_M._O._Smith
- 5.1.8 Hess, J.L., “Calculation of potential flow about bodies of revolution having axes perpendicular to the free-stream direction,” Journal of the Aerospace Sciences, Vol. 29, No. 6 (1962), pp. 726-742. <https://doi.org/10.2514/8.9591>
- 5.1.9 Hess, J.L. and Smith, A.M.O., “Calculation of potential flow about arbitrary bodies,” Progress in Aeronautical Sciences, Pergamon Press, Volume 8 (1967), pp 1-138
- 5.1.10 Rubbert, P.E. and Saaris, G.R., “A General Three-dimensional Potential Flow Method Applied to V/STOL Aerodynamics,” SAE Technical Paper 680304, 1968. <https://doi.org/10.4271/680304>
- 5.1.11 Hess, J. L., “Calculation of Potential Flow about Arbitrary Three-Dimensional Lifting Bodies,” Phase II, Final Report. McDonnell Douglas Report No. MDC J0971-01, October 1970.
- 5.1.12 Woodward, F.A., “An Improved Method for the Aerodynamic Analysis of Wing-Body-Tail Configurations in Subsonic and Supersonic Flow,” NASA CR-2228, 1973.
- 5.1.13 Magnus, A.E., Ehlers, F.E., and Epton, M.A., "PANAIR - A Computer Program for Predicting Subsonic or Supersonic Linear Potential Flow About Arbitrary Configurations Using a Higher-Order Panel Method," NASA CR-3251, April 1980.
- 5.1.14 Johnson, F.T., “A General Panel Method for the Analysis and Design of Arbitrary Configurations in Incompressible Flows,” NASA CR-3079, 1980.
- 5.1.15 Bristow, D.R. and Hawk, J.D., “Subsonic Panel Method for the Efficient Analysis of Multiple Geometry Perturbations,” NASA CR-3528, March 1982.

BIBLIOGRAPHY

SECTION 5.1 (contd.)

- 5.1.16 Maskew, B., "Prediction of Subsonic Aerodynamic Characteristics: A Case for Low-Order Panel Method," *Journal of Aircraft*, Vol. 19, No. 2, February 1982.
- 5.1.17 Maskew, B., "Program VSAERO: A Computer Program for Calculating the Non-linear Aerodynamic Characteristics of Arbitrary Configurations, User's Manual" NASA CR-166476, December 1982.
- 5.1.18 Hess, J.L. and Friedman, D.M., "An Improved Higher-Order Panel Method for Three-Dimensional Lifting Flows," NADC Report 79277-60, U.S. Naval Air Development Center, December 1981.
- 5.1.19 Maskew, B., "Prediction of Subsonic Aerodynamic Characteristics: A Case for Low-Order Panel Methods," *Journal of Aircraft*, Vol. 19, February 1982, pp. 157-163.
- 5.1.20 Coopersmith, R.M., Youngren, H.H., and Bouchard, E.E., "Quadrilateral Element Panel Method (QUADPAN)", User's Manual (Version 3), Lockheed-California Company, LR 29671, June 1983.
- 5.1.21 Coopersmith, R.M., Youngren, H.H., and Bouchard, E.E., "Quadrilateral Element Panel Method (QUADPAN)", Theoretical Report (Version 3), Lockheed-California Company, LR 30500, July 1983.
- 5.1.22 Youngren, H.H., Bouchard, E.E., Coopersmith, R.M., and Miranda, L.R., "Comparison of Panel Method Formulations and Its Influence on the Development of QUADPAN, an Advanced Low Order Method," AIAA Paper 83-1827, July 1983.
- 5.1.23 Fornasier, L., "HISSS—A Higher-Order Subsonic/Supersonic Singularity Method for Calculating Linearized Potential Flow," AIAA Paper 84-1646, June 1984.
- 5.1.24 Margason, R.J., Kjelgaard, S.O., Sellers, W.L., Morris, C.E., Walkey, K.B., and Shields, E.W., "Subsonic Panel Methods—A Comparison of Several Production Codes," AIAA Paper 85-0280, January 1985.
- 5.1.25 Johnston, C.E., Youngren, H.H., and Sikora, J.S., "Engineering Applications of an Advanced Low-Order Panel Method," SAE Paper 851793, October 1985.
- 5.1.26 Donham, R.E., Dupcak, J.D., and Conner, F., "Application of a Panel Method (QUADPAN) to the Prediction of Propeller Blade Loads," SAE Paper 861743, October 1986.
- 5.1.27 Tinoco, E.N., Ball, D.N., and Rice, F.A., II, "PANAIR Analysis of a Transport High-Lift Configuration," *Journal of Aircraft*, Vol. 24, March 1987, pp. 181-187.
- 5.1.28 Fornasier, L. and Heiss, S., "Application of HISSS Panel Code to a Fighter Type Aircraft Configuration at Subsonic and Supersonic Speeds," AIAA Paper 87-2619, August 1987.
- 5.1.29 Lednicer, D., "A VSAERO Analysis of Several Canard Configured Aircraft," SAE Paper 881485, SP-757, October 1988.
- 5.1.30 Harris, R.V., "An Analysis and Correlation of Aircraft Wave Drag," NASA TM X-947, March 1964.
- 5.1.31 Carlson, H.W. and Middleton, W.D., "A Numerical Method for the Design of Camber Surfaces of Supersonic Wings with Arbitrary Planforms," NASA TN D-2341, June 1964.

BIBLIOGRAPHY

SECTION 5.1 (contd.)

- 5.1.32 Baals, D.D., Robins, A.W., and Harris, R.V., "Aerodynamic Design Integration of Supersonic Aircraft," Journal of Aircraft, Vol. 7, No. 5, Sept-Oct 1970.
- 5.1.33 Pearcy, H.H., "The Aerodynamic Design of Section Shapes for Swept Wings," Advances in Aeronautical Sciences, Vol. 3, Pergamon Press, 1962.
- 5.1.34 Whitcomb, R.T., "Review of NASA Supercritical Airfoils," 9th Congress of the International Council of the Aeronautical Sciences, Haifa, Israel, 25-30 August, 1974, Proceedings, Vol. I, pp 8-18.
https://www.icas.org/ICAS_ARCHIVE/ICAS1974/Page%208%20Whitcomb.pdf
- 5.1.35 Murman, E.M. and Cole, J.D., "Calculation of plane steady transonic flows", AIAA Journal, Vol. 9, No. 1 (1971), pp. 114-121.
<https://doi.org/10.2514/3.6131>
- 5.1.36 Bailey, F.R. and Ballhaus, W.F., "Comparisons of Computed and Experimental Pressures for Transonic Flows about Isolated Wings and Wing-Fuselage Configurations," NASA SP-347, 1975, pp. 1213-1231.
- 5.1.37 Boppe, C.W., "Computational Transonic Flow About Realistic Aircraft Configurations," AIAA Paper 78-104, 16th Aerospace Sciences, Meeting, Huntsville, Alabama, 1978.
- 5.1.38 Jameson, A. and Caughey, D.A., "Numerical Calculation of the Transonic Flow Past a Swept Wing," COO-3077-140, ERDA Mathematics and Computing Laboratory, New York University, June 1977.
<https://ntrs.nasa.gov/archive/nasa/casi.ntrs.nasa.gov/19770020127.pdf>
- 5.1.39 Caughey, D.A. and Jameson, A., "Progress in Finite-Volume Calculations for Wing-Fuselage Combinations," AIAA Journal, Vol. 18, No. 11 (1980), pp 1281-1288. <https://arc.aiaa.org/doi/pdf/10.2514/3.50883>
- 5.1.40 Raj, P., Miranda, L.R., and Seebass, A.R., "A Cost-Effective Method for Shock-Free Supercritical Wing Design," AIAA Journal of Aircraft, Vol. 19, No. 4, April 1982, pp 283-289.
- 5.1.41 Raj, P. and Reaser, J.S., "An Improved Full-Potential Finite-Difference Transonic-Flow Code, FLO-22.5," Lockheed-California Company Report, LR 29759, June 1981.
- 5.1.42 Raj, P., "A Multigrid Method for Transonic Wing Analysis and Design," AIAA Journal of Aircraft, Vol. 21, No. 2, February 1984, pp 143-150.
- 5.1.43 Vassberg, J.C., "A Brief History of FLO22," JRV Symposium, San Diego, California, 22-23 June 2013.
- 5.1.44 Wigton, L.B., "Viscous-Inviscid Interaction in Transonic Flow," AFOSR-TR-81-0538, June 1981.
- 5.1.45 Lock, R.C., and Williams, B.R., "Viscous-Inviscid Interactions in External Aerodynamics," Progress in Aerospace Sciences, Vol. 24, 1987, pp. 51-171.
- 5.1.46 MacCormack, R. W., "Numerical Solutions of the Interaction of a Shock Wave with a Laminar Boundary Layer," Lecture Notes In Physics, Vol. 8, Springer-Verlag, New York, 1971, pp. 151-163.

BIBLIOGRAPHY

SECTION 5.1 (contd.)

- 5.1.47 Carter, J. E., "Numerical Solutions of the Navier-Stokes Equations for Supersonic Laminar Flow over a Two-Dimensional Compression Corner," NASA TR R-385, July 1972.
- 5.1.48 Li, C. P., "A Numerical Study of Laminar Flow Separation on Blunt Flared Cones at Angle of Attack," AIAA Paper 74-585, June 1974.
- 5.1.49 Wilcox, D. C., "Calculation of Turbulent Boundary-Layer Shock-Wave Interaction," *AIAA Journal*, Vol. 11, Nov. 1973, pp. 1592-1594.
- 5.1.50 Deiwert, G. S., "Numerical Simulation of High Reynolds Number Transonic Flow," AIAA Paper 74-603, June 1974.
- 5.1.51 Shang, J. S. and Hankey, W. L., "Numerical Simulation for Supersonic and Hypersonic Turbulent Flow over a Compression Ramp," *AIAA Journal*, Vol. 13, Oct. 1975, pp. 1368-1374.
- 5.1.52 Deiwert, G. S. and Bailey, H. E., "Prospects for Computing Airfoil Aerodynamics with Reynolds Averaged Navier-Stokes Codes," NASA CP 2045, 1978.
- 5.1.53 Dean R. Chapman, "Computational Aerodynamics Development and Outlook", *AIAA Journal*, Vol. 17, No. 12 (1979), pp. 1293-1313.
- 5.1.54 Chapman, D.R., Mark, H., and Pirtle, M.W., "Computers vs. Wind Tunnels for Aerodynamic Flow Simulations," *AIAA Astronautics & Aeronautics*, Vol. 13, No. 4, April 1975.
- 5.1.55 Stumpe, J., "Symbiosis: Why CFD and Wind Tunnels Need Each Other," *Aerospace America*, June 2018.
- 5.1.56 Raj, P. and Gray, R.B., "Computation of Two-Dimensional Potential Flow Using Elementary Vortex Distributions," *AIAA Journal of Aircraft*, Vol. 15, No.10, October 1978, pp. 698-700.
- 5.1.57 Raj, P. and Gray, R.B., "Computation of Three-Dimensional Potential Flow Using Surface Vorticity Distribution," *AIAA Journal of Aircraft*, Vol. 16, No. 3, March 1979, pp 162-169.
- 5.1.58 Raj, P. and Iversen, J. D., "Inviscid Interaction of Trailing Vortex Sheets Approximated by Point Vortices," *AIAA Journal of Aircraft*, Vol.15, No.12, December 1978, pp. 857-859.
- 5.1.59 Raj, P. and Iversen, J.D., "Computational Simulation of Turbulent Vortex Merger and Decay," *AIAA Journal*, Vol. 18, No. 8, August 1980, pp. 865-866.
- 5.1.60 Iversen, J.D., Brandt, S.A., and Raj, P., "Merging Distance Criteria for Corotating Trailing Vortices," *Proceedings U.S. Department of Transportation Conference on Aircraft Trailing Vortices*, Cambridge, MA, March 15-17, 1977.

	Slide #
Preface	3
1. Introduction and Scope	11
2. Genesis of Fluid Dynamics (<i>Antiquity to 1750</i>)	52
3. Fluid Dynamics as a Mathematical Science (<i>1750–1900</i>)	77
4. Emergence of Computational Fluid Dynamics (<i>1900–1950</i>)	98
5. Evolution of Applied Computational Aerodynamics (<i>1950–2000</i>)	124
5.1 <i>Infancy through Adolescence (1950–1980)</i>	127
Level I: Linear Potential Methods (LPMs)	127
Level II: Nonlinear Potential Methods (NPMs)	138
5.2 <i>Pursuit of Effectiveness (1980–2000)</i>	163
Level III: Euler Methods	167
Level IV: Reynolds-Averaged Navier-Stokes (RANS) Methods	210
6. ACA Effectiveness: Status and Prospects (<i>2000 and Beyond</i>)	229
6.1 <i>Assessment of Effectiveness (2000–2020)</i>	231
6.2 <i>Prospects for Fully Effective ACA (Beyond 2020)</i>	261
7. Closing Remarks	286
Appendix A	295

ACA Effectiveness Codified: 1980-81

Luis R. Miranda



Manager
Computational Aerodynamics
Lockheed-California Co.

Effectiveness = quality x acceptance

- **Quality factor:** accuracy and realism of numerical flow simulation
- **Acceptance factor:** applicability, usability, and affordability of selected computational method

Unveiled by Luis Miranda in AIAA 82-0018, Jan 1982

(published in Journal of Aircraft, 21(6), 1984)

“Although this expression [of effectiveness] has no actual quantitative value it serves to emphasize an often overlooked axiom: The impact that a given process has on the activity for which it is intended depends not only on how good the process itself is but also on how widely used or accepted it is.”

“Effectiveness of computational aerodynamics in a design environment will depend on the nature of the elements that constitute the computer codes used in a numerical flow simulation.”

“If increasing the accuracy of a computational procedure will detract from its ease and economy of use, the implied tradeoff between quality and acceptance should be considered carefully to determine if its effectiveness will actually be enhanced by the increase in accuracy.”

Effectiveness = quality x acceptance is **Broadly Applicable**

“I've had to terminate or fire more people for being difficult to work with than being dumb.”

Brian Krzanich
Intel CEO (May 2013–June 2018)

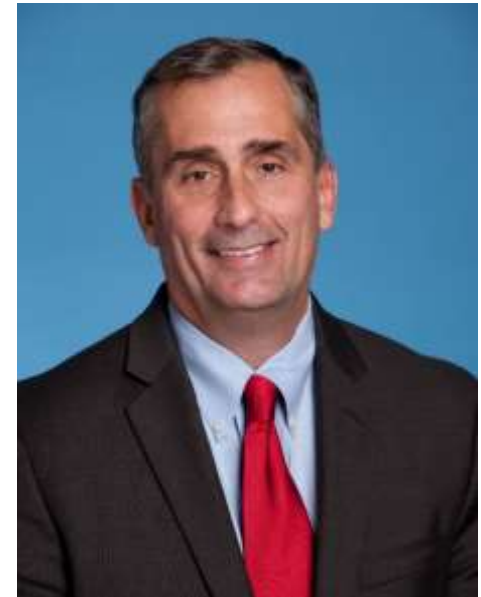

For Engineering Team Members

Quality Factors: knowledge and skills

Acceptance Factors: attitude and adaptability

Effectiveness isn't Just for ACA!

Lockheed ACA Development

Late 1970s and Early 1980s

- **QUADPAN (Quadrilateral Panel)
Linear Potential Method (*Youngren, Coopersmith, Bouchard and Miranda*)

 - **Low-order Formulation:** *As accurate as high-order for subsonic flows at greatly reduced cost*
 - **Source/doublet Singularities with Dirichlet BC:** *Essential for robustness*
 - **Pressure Formula Consistent with Linear Theory:** *Accurate force calculations*
 - **Modified Kutta Condition:** *For trailing edges with large included angles***



“The Quad Squad”

- | | |
|--------------------------|---------------------------|
| 1. Guppy Youngren | 2. Bob Coopersmith |
| 3. Gene Bouchard | 4. Luis Miranda |

- **FLO 22.5: More Effective Nonlinear Full Potential Method** (*Raj & Reaser*)
 - **Better Geometry Modeling:** *Planform-conforming grid for tapered wings*
 - **Faster Turnaround:** *Multi-grid acceleration*
 - **Simulation Realism:** *Fuselage effects; Viscous effects (interactive boundary layer coupling)*
 - **Wing Design:** *Garabedian-McFadden supercritical wing design technique*
 - **Documentation:** *LR 29759; AIAA 83-0262; also Journal of Aircraft, 21(2), 1984*

Key Driver: Effectiveness (= quality x acceptance)

1981: A Pivotal Year for Lockheed

- **December 7, 1981**

- Lockheed discontinues L-1011 *(after \$2.5B loss in 13 years!)*
 - ✓ Concentrate instead on defense opportunities expected under Reagan military buildup



- **November 1981**

- Department of Defense approves Milestone 0 for **Advanced Tactical Fighter (ATF)** —*a new air superiority fighter* (to replace F-15)
- **Fighter aerodynamics dominated by strong shocks and free-vortex flows**



Computational simulation of flows with strong shocks and free vortices falls outside the range of validity of linear and nonlinear potential methods

ATF Provides Impetus for Exploring Euler Methods

Level III Euler Methods 1980s - present

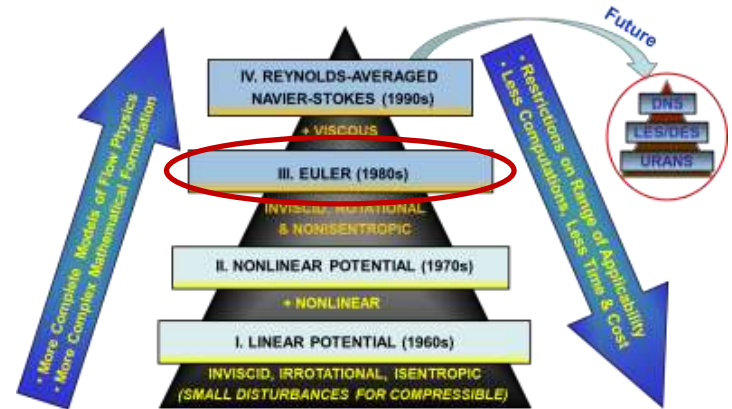

Flow Model

- **Inviscid, Irrotational, Isentropic**

$$Q_t + F_x + G_y + H_z = 0$$

$$Q = (\rho, \rho u, \rho v, \rho w, \rho E)$$

- ✓ System of nonlinear 1st order PDEs with appropriate boundary conditions

Applicability

- All Mach numbers and attitude angles
- Flow may have shocks and free vortices as long as it's not dominated by boundary-layer separation

Four Major Developments of the Eighties

VIDEO CASSETTE RECORDER

COMPACT DISK PLAYER

EULER SOLVER

ГЛАСНОСТЬ

Source: Bram van Leer presentation at one of the AIAA
Aerospace Sciences Meeting in Reno, NV, in the late 1980s

Bram van Leer



Professor Emeritus
University of Michigan
*Major contributions to CFD, Fluid
Dynamics and Numerical Analysis*

1980s: 'Golden Era' of Euler Methods

A Small Sample of Euler Solvers: 1980s

- **Rizzi and Eriksson (1981)**
 - *Grid generation*: Transfinite interpolation for 3-D boundary-conforming structured grids on wings or wing-bodies; O-O and C-O topologies most efficient
 - *Euler solver*: Explicit pseudo time-marching scheme; nonreflecting boundary conditions; damping filter to improve convergence—**AIAA Paper 81-0999**
 - Shocks and wakes automatically “captured”; no explicit imposition of Kutta condition as long as the trailing edge was sharp
- **Jameson, Schmidt, and Turkel (1981)**
 - *Strategy*: Finite volume formulation decouples solver and grid; structured C and O meshes
 - *Features*: Cell-centered spatial discretization; a blend of second- and fourth-differences for numerical dissipation with pressure gradient sensor; convergence acceleration to steady state using multi-stage pseudo-time stepping procedure—**AIAA Paper 81-1259**
- **Usab and Murman (1983)**
 - Embedded mesh solutions on airfoils using a multiple-grid method—**AIAA Paper 83-1946**
- **Benek, Buning and Steger (1985)**
 - A 3-D Chimera grid embedding scheme [hexahedral grids]—**AIAA Paper 85-1523**
- **Löhner, Morgan, Peraire and Zienkiewicz (1985)**
 - Finite-element methods for high speed flows [tetrahedral grids]—**AIAA Paper 85-1531**
- **Jameson, Baker and Weatherill (1986)**
 - Inviscid Transonic Flow over a Complete Aircraft [hexahedral grids]—**AIAA Paper 86-0103**
- **Mavriplis (1988)**
 - Accurate multigrid solutions on unstructured and adaptive meshes—**NASA CR 181679**

Pioneering Euler Solutions: 1981

Rizzi and Eriksson (1981)

- *Grid generation*: Transfinite interpolation for 3-D boundary-conforming hexahedral grids on wings or wing-bodies; O-O and C-O topologies most efficient
- *Euler solver*: Explicit pseudo time-marching scheme; nonreflecting boundary conditions; damping filter to improve convergence—**AIAA Paper 81-0999**
- Shocks and wakes automatically “captured”; no explicit imposition of Kutta condition for sharp trailing edge

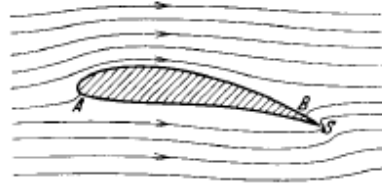
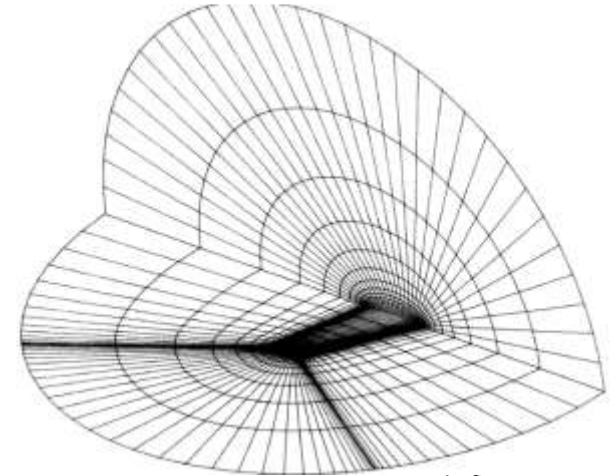

(a)

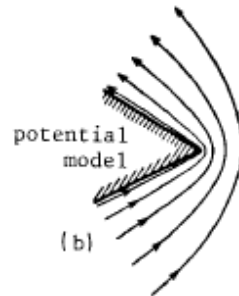

(b)

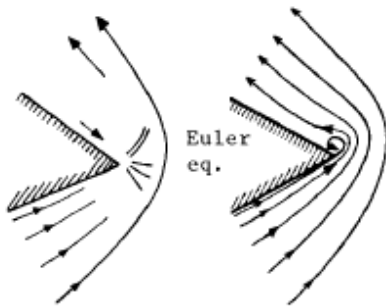

(c)



(d)



(e)

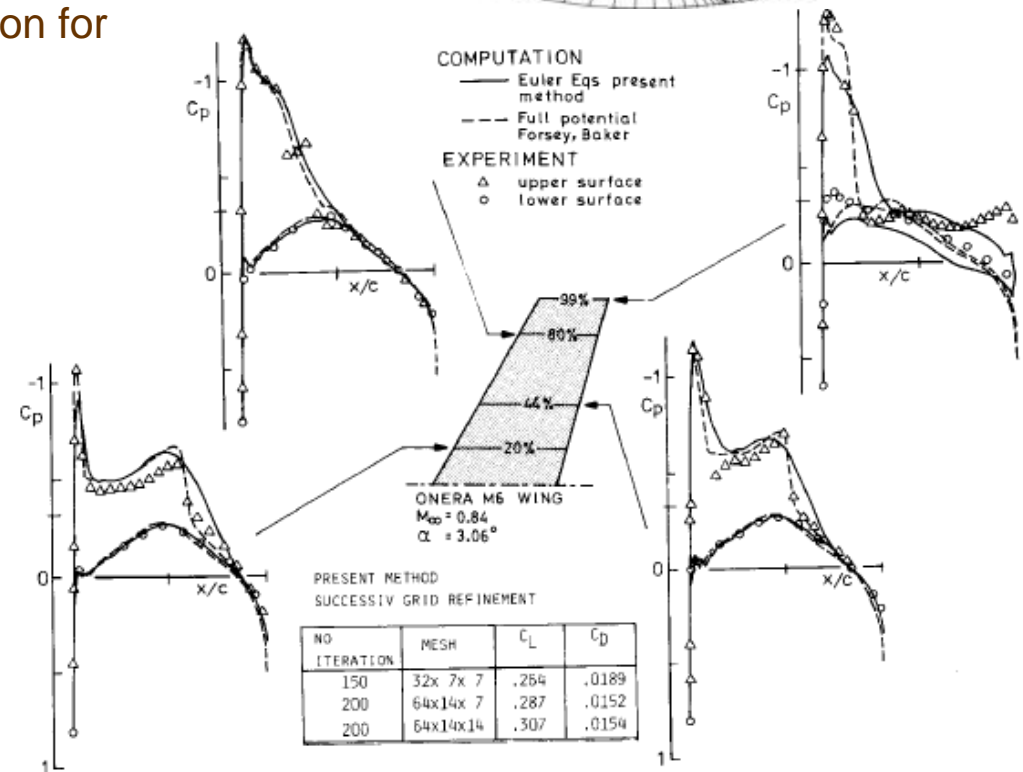

Efficient Euler Solver: 1981

- **Jameson, Schmidt, and Turkel (AIAA Paper 81-1259)**
 - Purpose: *develop economical methods!*
 - Finite volume formulation decouples solver and grid
 - Investigation of alternative **2-D** schemes to answer four questions:
 1. **What is the most efficient time stepping scheme?**
 - Fourth order Runge-Kutta time stepping scheme
 2. **What is the optimal form of the dissipative terms?**
 - Adaptive blend of second and fourth differences with local pressure gradient sensor (*JST scheme*)
 3. **What is the best way to treat the boundary conditions at the body and in the far field?**
 - Appropriate characteristic combinations of variables
 4. **How can convergence to a steady state be accelerated?**
 - Variable time step at the maximum limit set by the local Courant number: $\sum(u_i \Delta t / \Delta x_i) \leq C_{max}$
 - Add a forcing term based on the difference between the local total enthalpy and its free stream value (*energy equation must be integrated in time, and not eliminated in favor of the steady state condition that the total enthalpy is constant*)
- **Jameson creates FLO-57 using JST scheme for 3-D swept wings soon after**

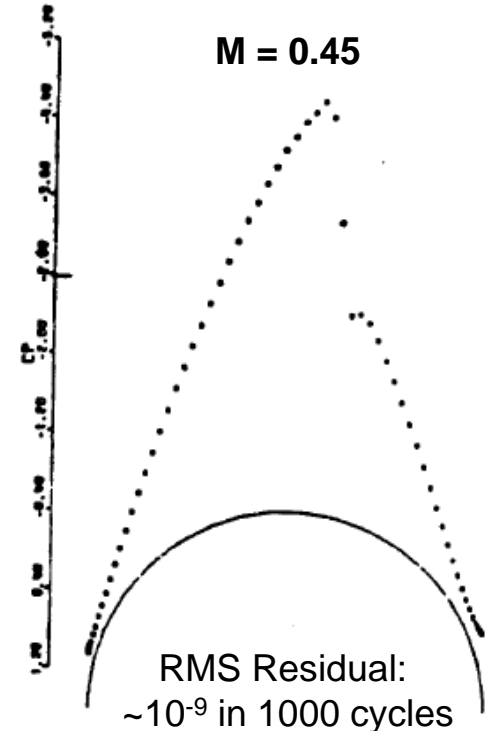
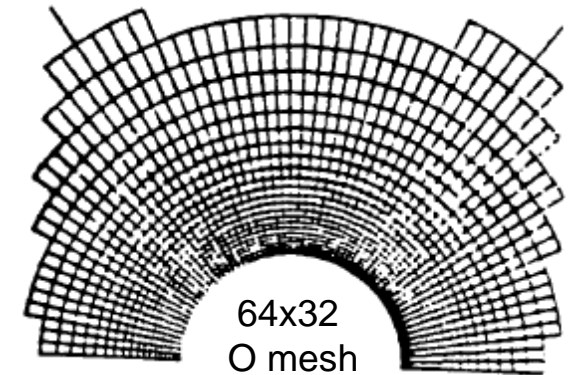

Towards Euler Solutions on Complex Geometries: 1983-84

- **Usab and Murman (1983)**
 - Embedded Mesh Solutions Of The Euler Equation Using A Multiple-grid Method—*AIAA Paper 83-1946*

RAE 2822 Airfoil

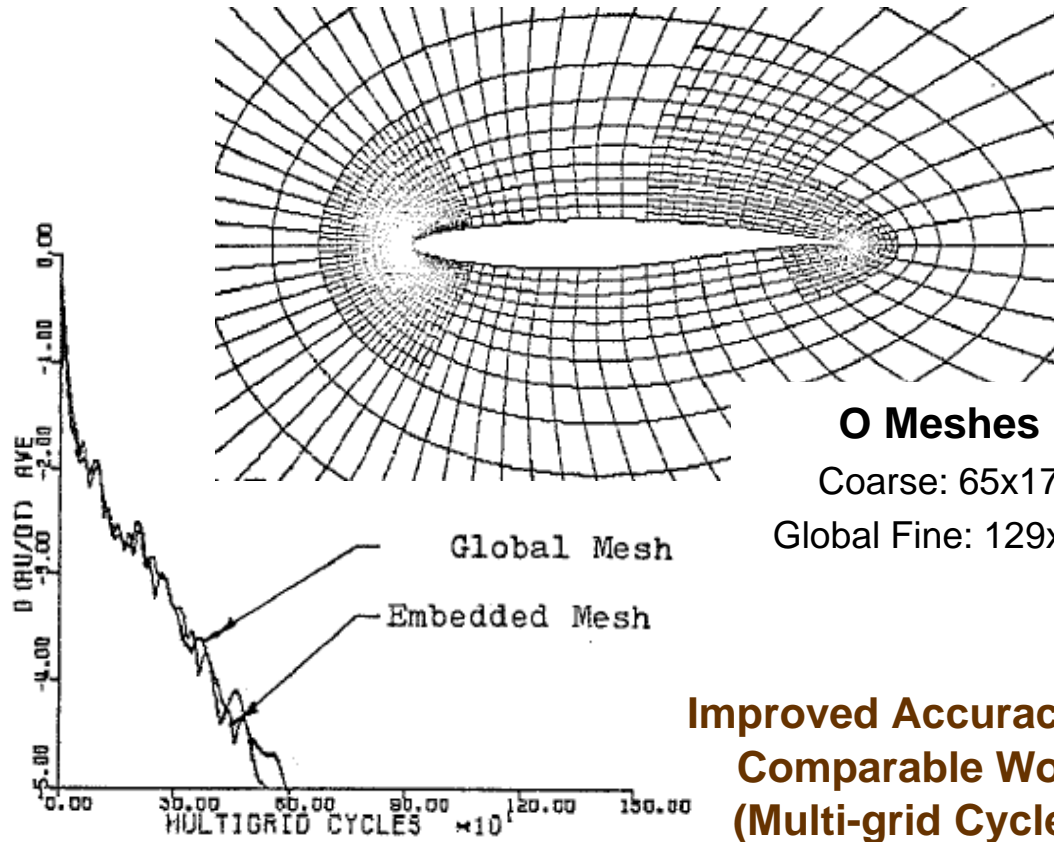

Improved Accuracy for Comparable Work (Multi-grid Cycles)

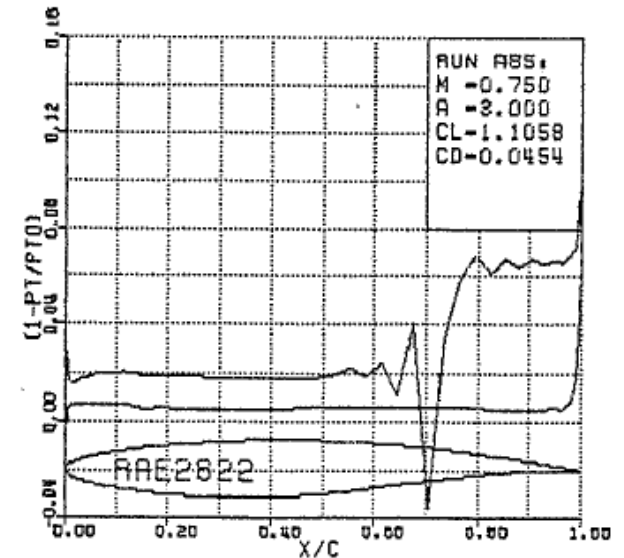
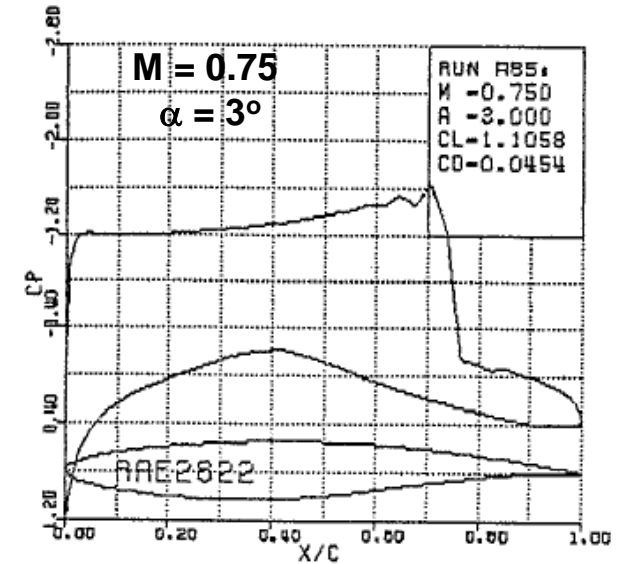

- **Jameson and Baker (1984)**
 - Multigrid solution for aircraft configurations—*AIAA Paper 84-0093*

Overlapping Embedded Mesh Scheme for Complex Geometries: 1985

Benek, Buning and Steger (1985)

- A 3-D Chimera grid embedding scheme—*AIAA Paper 85-1523*
- Boundary conforming grids on component parts of the geometry

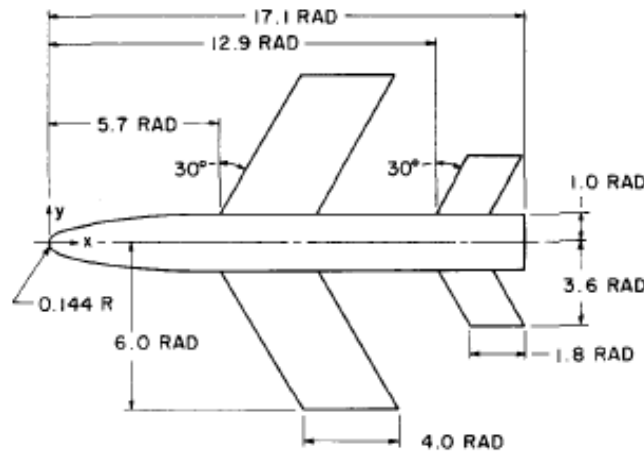
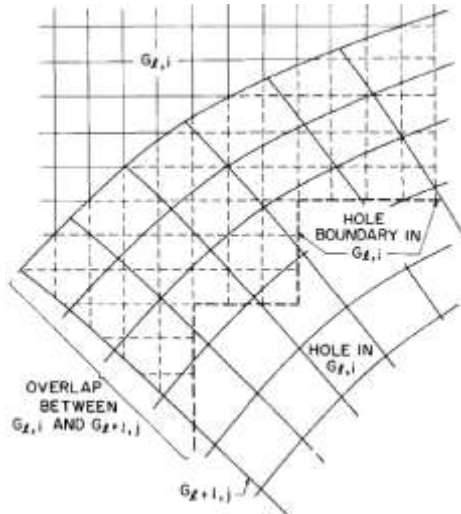

Wing/Body Computations

Fuselage Grid:

47x25x25

Wing Grid:

66x23x11

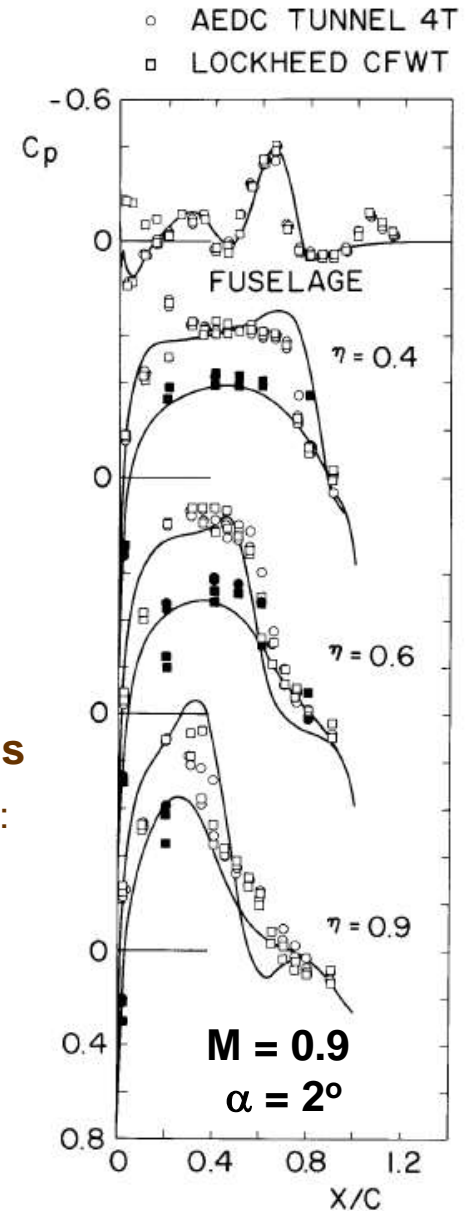
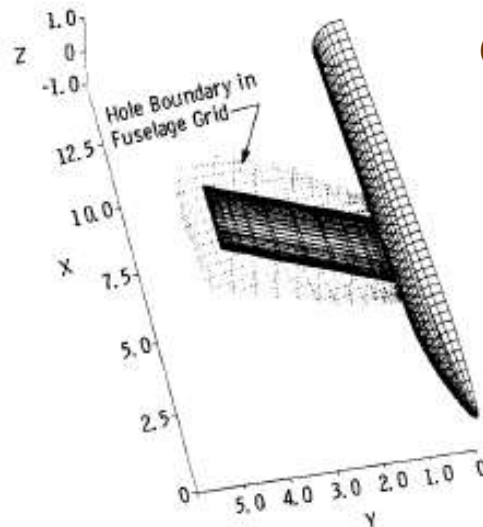
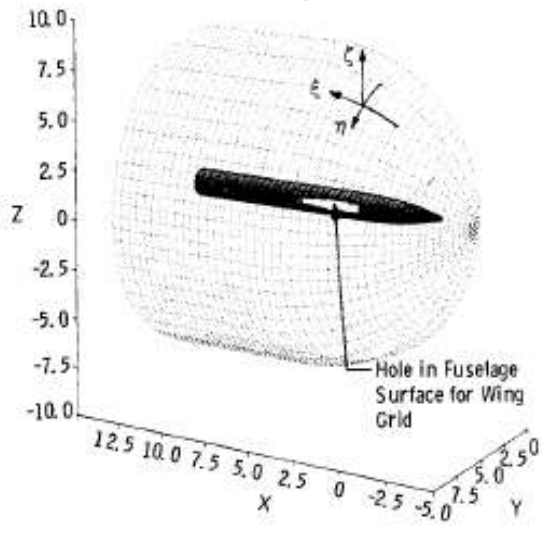

Löhner, Morgan, Peraire and Zienkiewicz (1985)

- Finite-element methods for high speed flows—*AIAA Paper 85-1531*

Mach 2 Inviscid Steady Flow past a Simulated Nose Cone Section

Adaptive Mesh Refinement

Inviscid Shock Reflection off Solid Wall

Adaptive Mesh Refinement

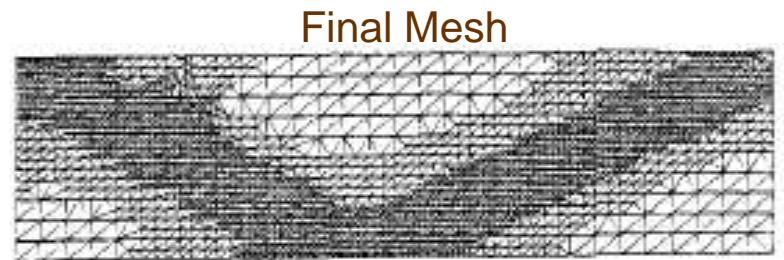
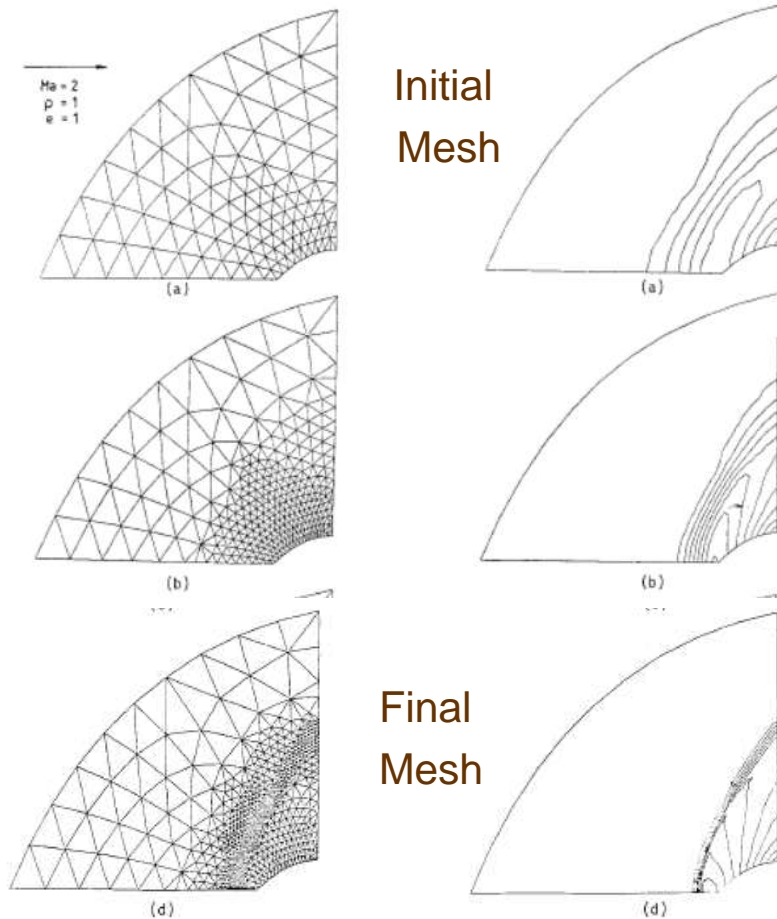

Jameson, Baker and Weatherill (1986)

- Calculation of Inviscid Transonic Flow over a Complete Aircraft—*AIAA Paper 86-0103*
- Generate separate meshes for each aircraft component
- Unite mesh points from several overlapping meshes to form a single cloud of points
- Use Delaunay triangulation to connect cloud of points to form tetrahedral cells
- Solve Euler equations using a new finite element approximation for polyhedral control volumes formed by the union of tetrahedra meeting at a common vertex

Preliminary Solutions for B747-200: Surface Pressure Contours

$$M = 0.84, \alpha = 2.73^\circ$$

Tetrahedral Mesh

12038 Nodes
57914 Cells

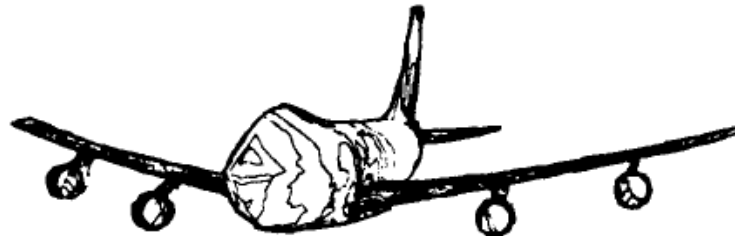
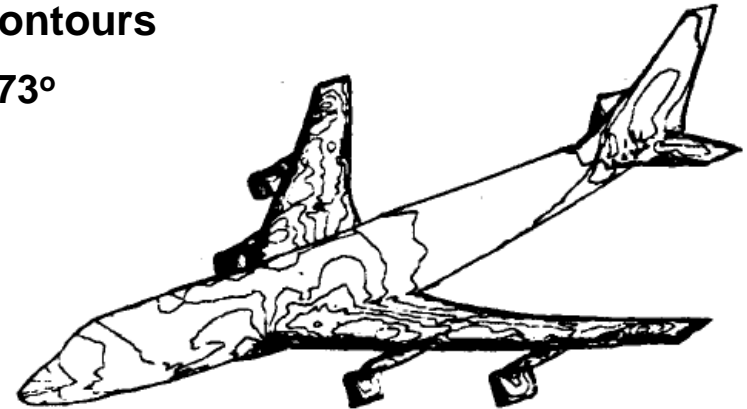
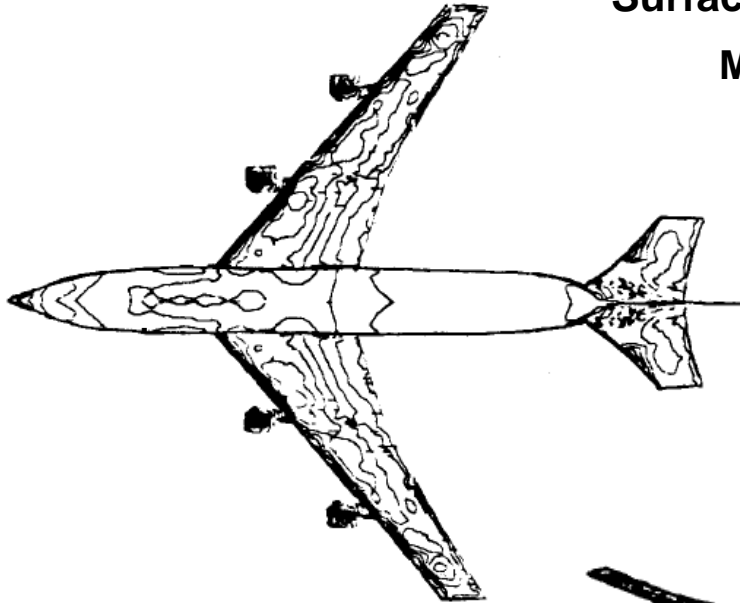

Accurate Euler Solutions on Unstructured Adaptive Meshes: 1988

Mavriplis (1988)

- Accurate multigrid solutions on unstructured and adaptive meshes—**NASA CR 181679**

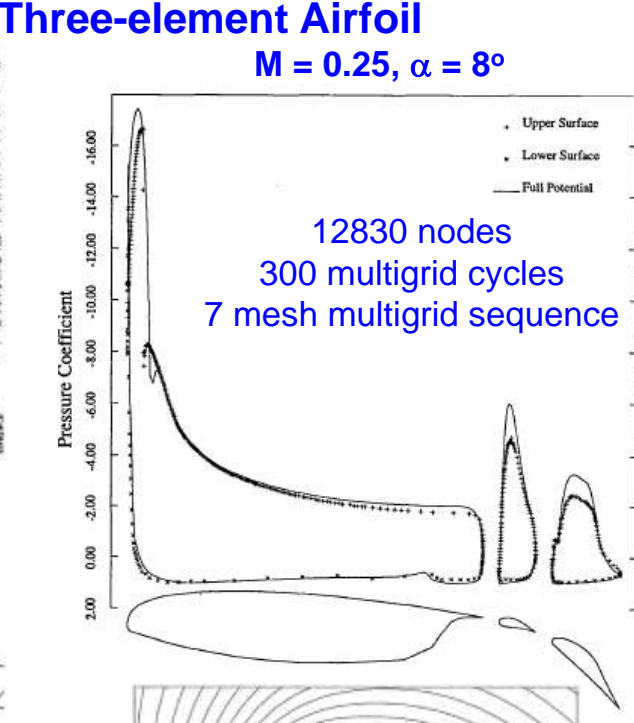
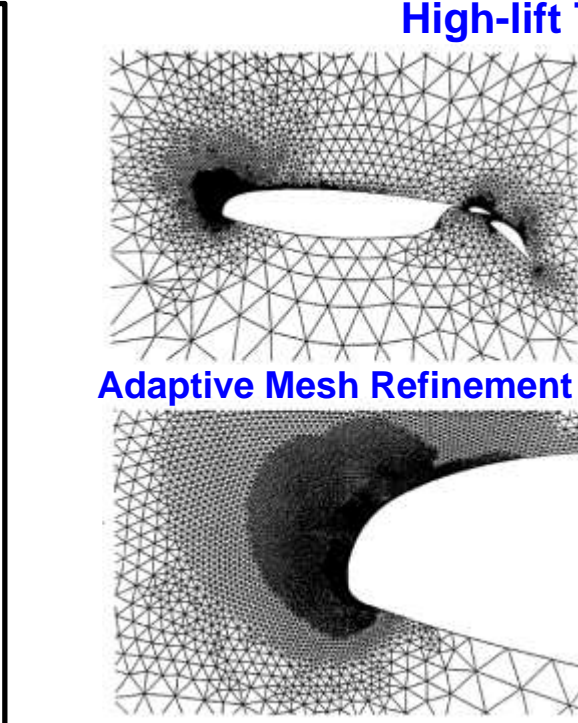
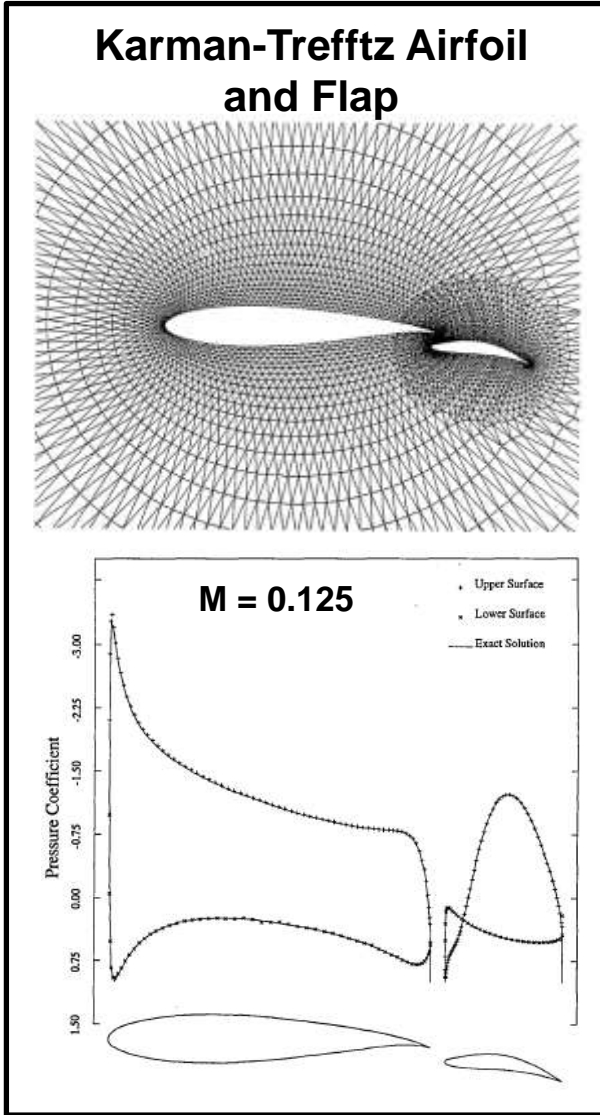

	Main Airfoil		Flap		Total	
	Cl	Cd	Cl	Cd	Cl	Cd
Nodal Scheme	1.7005	-0.0906	0.3357	0.0890	2.0362	-0.0016
Analytical Incompressible Solution	1.6915	-0.0898	0.3366	0.0897	2.0281	-0.0001

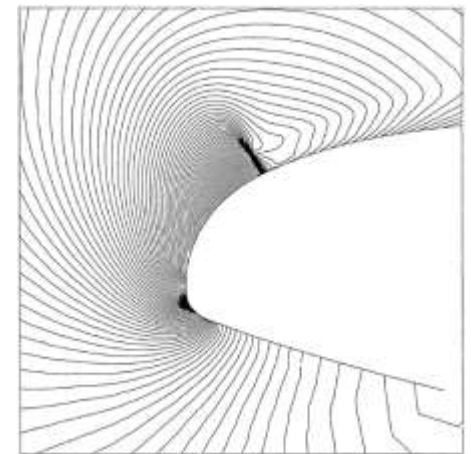

Lockheed Focus in the 1980s

Full Aircraft Euler Analysis to Meet ATF Needs

1981

- Jameson creates **FLO 57** code for swept wings (using JST scheme in AIAA 81-1259)
- Finite volume formulation decouples solver and grid
- **Shocks and wakes automatically “captured”** without explicit imposition of Kutta condition as long as the trailing edge is sharp

1982

- Lockheed initiates **FLO 57GWB** development (*PI: Raj*) by extending FLO-57 swept wing code to generalized wing-body configurations [*FLO 57 source code courtesy of R.M. Hicks, NASA-Ames*]
- **Alan Brown**, F-117A Program Manager and Chief Engineer, recommends research in free-vortex interaction with vertical tails!



1984

- Lockheed wins USAF Wright Research & Development Center (WRDC) contract for **Three-dimensional Euler Aerodynamic Method (TEAM)**
- **Antony Jameson** visits Lockheed! *A fascinating individual with singular intellect!*

1987

- USAF amends contract scope and extends period of performance
Three-dimensional Euler/Navier-Stokes Aerodynamic Method (TEAM)

1989

- USAF contract successfully completed; work documented in three USAF reports

USAF WRDC* Leads the Way

Towards Full Aircraft Computational Simulation Capability (1984)

Contract Requirements

- Aerodynamic analysis of fighter, transport, and flight research configurations with multiple lifting surfaces and flow-through or powered nacelles
- Symmetric or asymmetric flights at subsonic through hypersonic speeds for wide range of attitude angles
- Forces, moments, surface pressures, off-body pressures, velocities, etc.
- Validate code using 10 test cases

Lockheed Team

- Raj (Principal Investigator) with Brennan, Keen, Long, Mani, Olling, Sikora, and Singer contributing over five years under Miranda's leadership and supervision

USAF Monitors

- Jobe, Sirbaugh, Jochum, Witzeman, Sedlock, Kinsey

Strategy for Effectiveness

- **Modular Computational System:** (i) Pre-processor; (ii) Grid Generator; (iii) Euler Solver; and (iv) Post-processor—easier to incorporate technology advances
- **Patched Zonal Hexahedral Grids:** multiple topologies, grid generator of user's choice—facilitates analysis of complex configurations

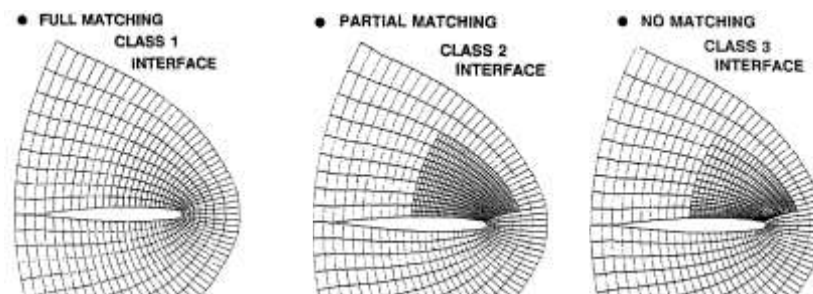

- **Spatial Discretization:** FLO-57 finite-volume formulation, cell-centered scheme with
 - JST adaptive dissipation—balanced accuracy and robustness
 - Characteristics-based—increased robustness for hypersonic flows
- **Time Discretization:** multistage pseudo-time stepping to steady state—faster turnaround

USAF/WRDC/Lockheed TEAM Code

TEAM Preprocessor Module

- **Primary Function: *Construct Suitable Surface Geometry of the Configuration to be Analyzed***
 - Surface grid is the starting point of field grid generation
- **Scope**
 - Depends on the complexity of the configuration, and the field-grid generation method
- **Approach**
 - Use Interactive Graphical Geometry Generation (I3G) in CDMS (Configuration Data Management System)

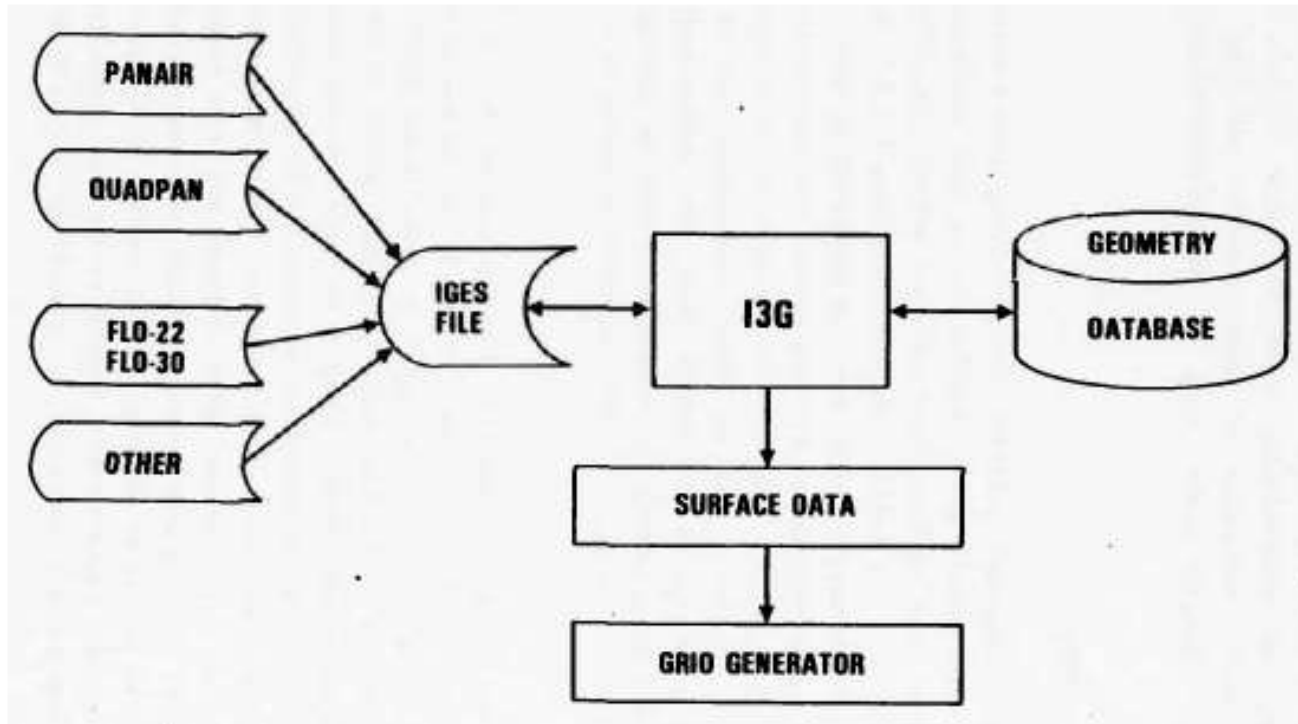

TEAM Grid Generation Module

- **Primary Function: Generate Suitable Structured Grids (Meshes) for Flow Analysis**

- An ordered set of points at the intersection of coordinate lines in a curvilinear system defined by a mapping of physical domain in Cartesian system to a rectangular box
- Hexahedral cells in 3D and quadrilateral in 2D

- **TEAM flow solver does *not* require functional description of curvilinear system, only the nodal point coordinates in the physical domain**

- Both domains must be right handed systems
- Grids must be boundary conforming, i.e., boundaries of physical domain should map to coordinate surfaces in Curvilinear domain

- **Desirable Grid Characteristics for TEAM Euler solver**

- Grid lines emanating from the configuration surface should be nearly normal to it
- Grid lines of same family should not cross each other
- Grid points should be distributed in a manner conducive to minimizing truncation error
- Abrupt changes in grid spacing should be avoided
- Zonal interfaces between grids of different densities should be away from critical flow regions
- Grid topologies that provide optimum resolution of flow features with minimum number of grid points are preferable

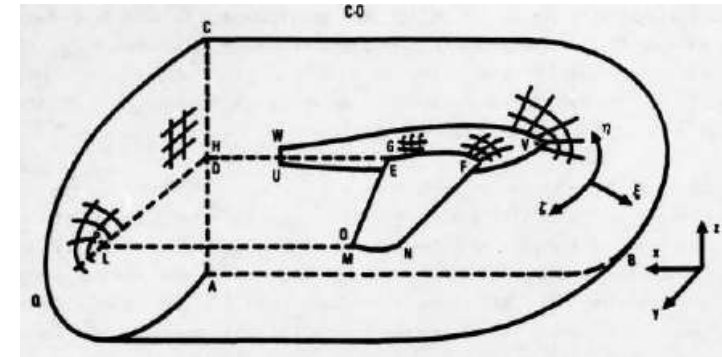

Physical domain

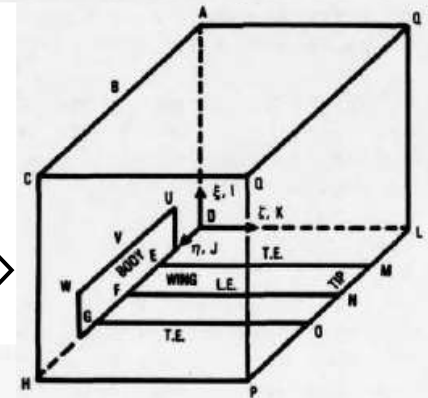

Mapped domain

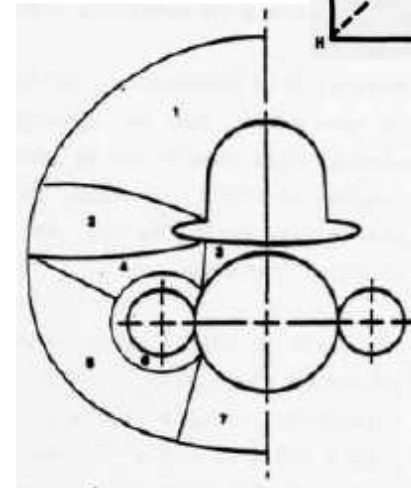

Zonal interfaces of a patched multi-zone grid

TEAM Structured Grid Topologies

- Structured Grids consist of an ordered set of quadrilateral (2D) or hexahedral (3D) cells
- Cells formed by the intersection of curvilinear coordinate surfaces

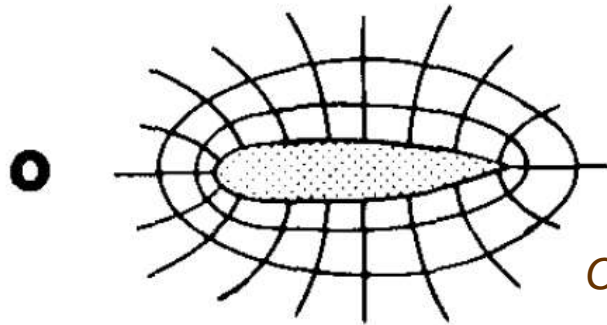

*O-O topology:
most efficient*

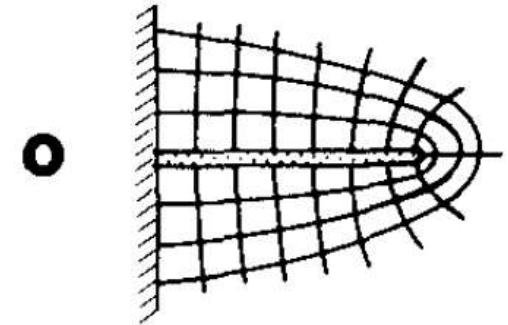

Chordwise Section: AB

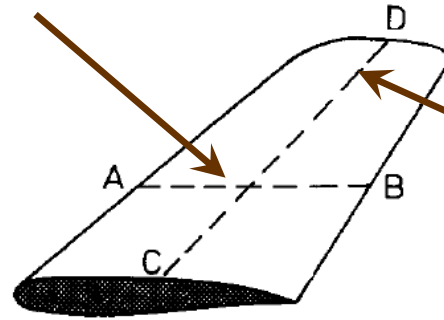

Spanwise Section: CD

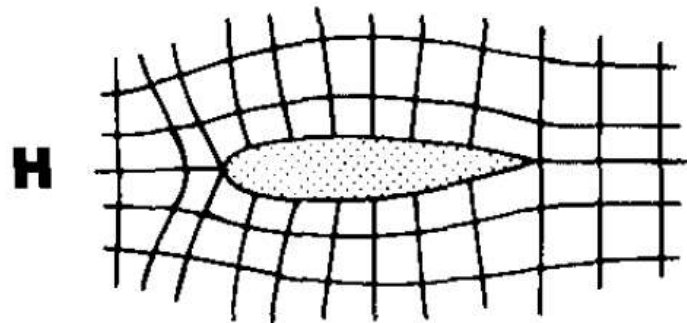
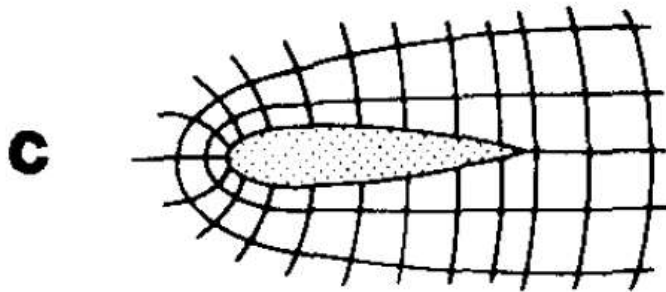

*H-H topology:
least efficient*

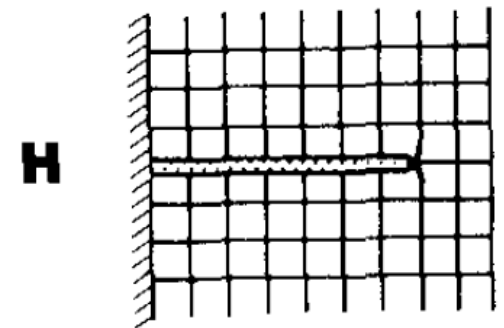

Codes	PACMAPS II	HYPERGRID	BIG	TFI3D	EAGLE
Formulation	Parabolic and Conformal Mapping	Hyperbolic PDE	Boundary Integral Grid Generation	Trans-finite Interpolation (Algebraic)	Elliptic PDE
Quality Factors	<ul style="list-style-type: none"> • Wing & Wing-Body • C-H grids only • Limited grid spacing control • No outer boundary control 	<ul style="list-style-type: none"> • Wing & Wing-Body • Surface grid determines field grid topology • Orthogonal grid lines • Grid spacing control • No outer boundary control 	<ul style="list-style-type: none"> • Wing; Wing-Body; and Wing-Body Tail/Canard • O-O or C-O grids • Orthogonal grid lines • No explicit grid spacing control • No outer boundary control 	<ul style="list-style-type: none"> • Full Aircraft • Explicit grid spacing control • Well-suited for multi-block grids 	<ul style="list-style-type: none"> • Full Aircraft • Grid spacing control
Acceptance Factors	<ul style="list-style-type: none"> • Automated • Fast and easy to use • Simple input: cross-sections only 	<ul style="list-style-type: none"> • Automated • Only surface grid input • Sensitive to initial data 	<ul style="list-style-type: none"> • Automated but compute-intensive • Easy to use • Only surface grid input 	<ul style="list-style-type: none"> • Extensive user interaction 	<ul style="list-style-type: none"> • Automated but compute-intensive • Needs user interaction

Varying Degrees of Effectiveness—None Satisfactory for Full Aircraft Grid Generation

TEAM Flow Solver Module

- **Primary Function: Solve Time-dependent, Integral Form of Euler (and RANS) Equations**
 - Based on Jameson's finite-volume formulation in FLO-57
- **Cell-centered Spatial Discretization**
 - Flow variables defined at cell centers, fluxes computed at faces
 - Central-difference scheme with 2nd order accuracy on smooth grids
 - Numerical dissipation terms added to (i) suppress odd-even decoupling; (ii) prevent instability; and (iii) cleanly capture shocks
 - **Adaptive Dissipation Models**
 - ✓ *Standard Adaptive Dissipation*: JST scheme, a blend of 2nd and 4th differences each scaled by user-specified factors; 2nd differences also scaled by normalized magnitude of the 2nd difference of static pressures
 - ✓ *Modified Adaptive Dissipation*: replaced user-specified factor for 2nd differences in each parametric direction by corresponding spectral radii, and bounded to produce locally Total Variation Diminishing (TVD) scheme
 - ✓ *Flux-limited Adaptive Dissipation*: non-oscillatory shock capture (Jameson, MAE Report 1653)
 - **Characteristics-based Dissipation Model**
 - ✓ Symmetric TVD provides appropriate upwind bias for supersonic and hypersonic flows
- **Multi-stage Time Stepping**
 - Local rather than global minimum time step (pseudo time) for computationally efficient convergence to steady state
 - Enthalpy damping and implicit residual smoothing to further accelerate convergence rate

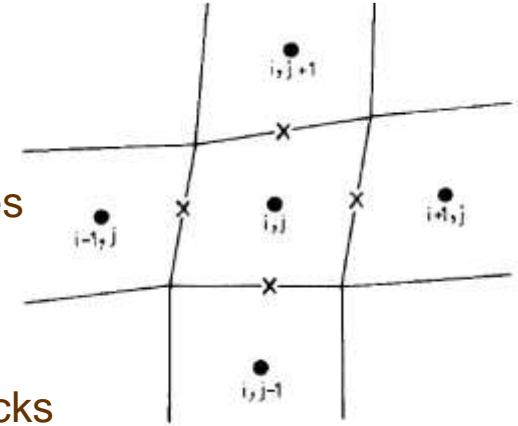

TEAM Postprocessor Module

- **Primary Function:** *Extract Meaningful Aerodynamic Data from Flow Solver Output Files*
- **Scope**
 - Forces and moments, surface pressure distributions, velocity fields, etc.
 - Display data in graphical form, such as charts, contour plots, etc.
- **Approach**
 - Use CDMS (Configuration Data Management System) capabilities

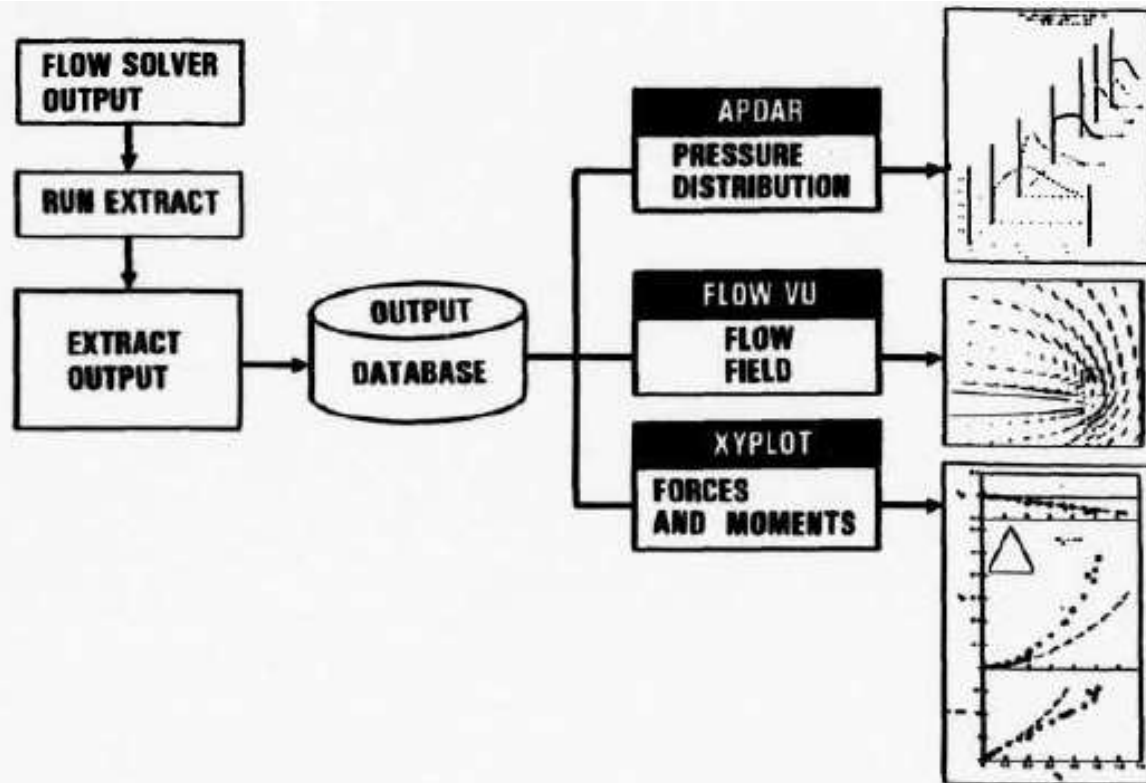

Team (Euler) Validation

1985-1988

- **NLR 7301 airfoil – Transonic Flow (2D)**
- **Wing/Body/Canard configuration – Subsonic & Transonic Flows (3D)**
 - *Subsonic ($M = 0.6$) and Transonic ($M = 0.9$)*
- **Three Internal Flow Test Cases – Subsonic & Supersonic Flow**
 - *Axisymmetric Diverging Nozzle*
 - *1-D Inlet Duct Hammershock*
 - *External Compression Mach 2.5 Axisymmetric Inlet*
- **Cone-derived Waverider – Hypersonic Flow**
- **Four Free-Vortex Flow Test Cases – Subsonic and Transonic Flow**
 - *Sharp-edged Cropped Delta Wing*
 - *Arrow Wing*
 - *Strake-Wing Body configuration*
 - *Double-Delta Wing Body configuration*

TEAM (Euler) Validation

NLR 7301 Airfoil – *Transonic Flow (2D)*

Comparison with exact shock-free hodograph solution

$$M_\infty = 0.721, \alpha = -0.194^\circ$$

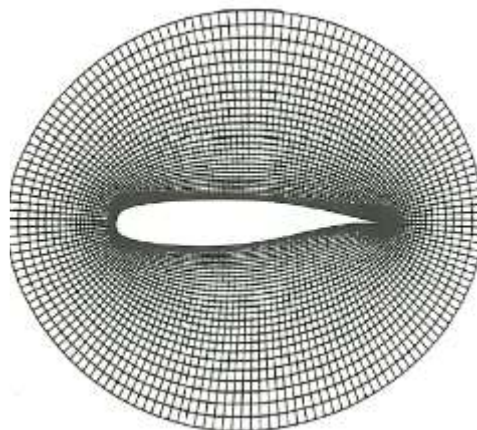

321 x 321 O Grid
(Far-field boundary
80 chords away)

Surface pressure distribution

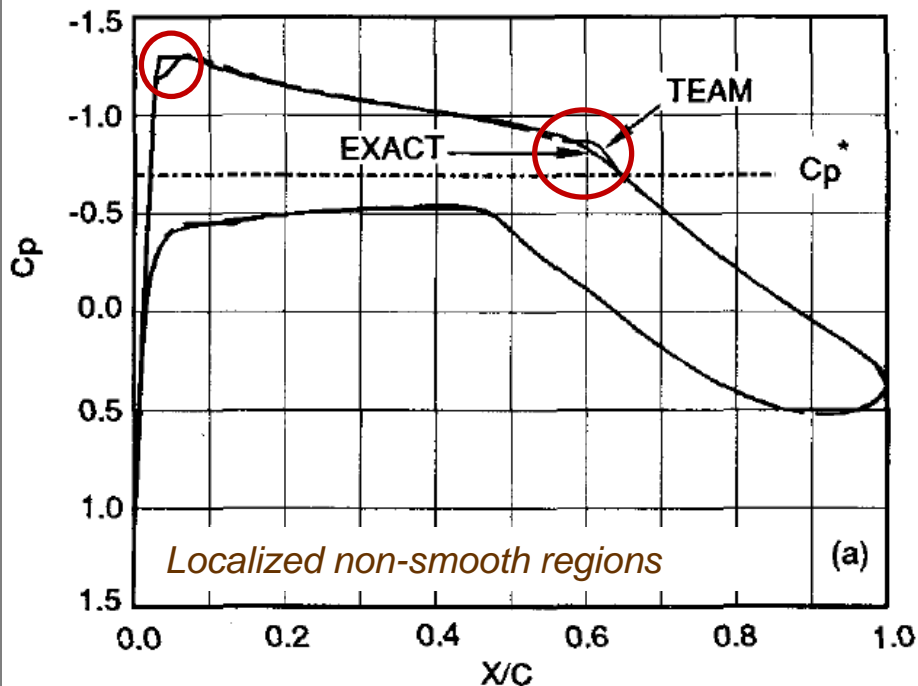

Surface total pressure loss distribution

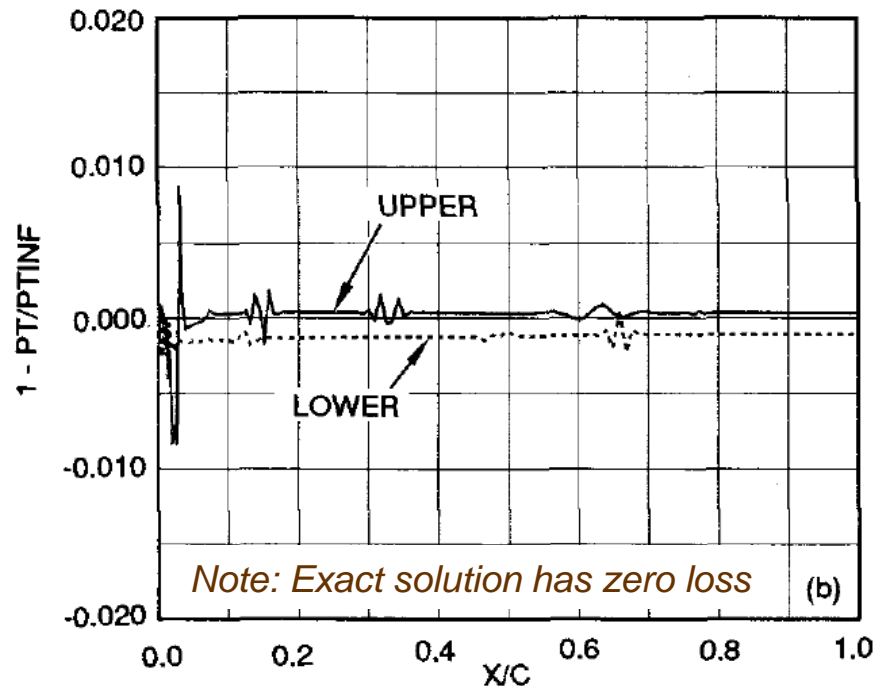

TEAM (Euler) Validation

NLR 7301 Airfoil - *Transonic Flow (2D)*

$M_\infty = 0.721$, $\alpha = -0.194^\circ$ Shock-free “exact” solution: $C_l = 0.5939$, $C_d = 0.0$

Sensitivity of Euler Solutions to Grid Density and Numerical Dissipation

- **Grid density (O grids)**

- Far-field boundary 80 chords away to avoid using far-field vortex correction
- Non-smooth C_p distribution near the leading edge on the upper surface most likely due to small ‘non-smooth’ region of the airfoil geometry that was defined by a discrete set of points
- Computed solutions exhibit “wiggle” in transition from supersonic to subsonic flow
 - amplitude *increases* as grid points in circumferential direction increase from 161 to 241 to 321 for points in radial direction (between surface and far-field boundary) fixed at 49
 - Wiggle amplitude *decreases* as grid density changes from 33x241 to 49x241 to 65x241 to 81x241
- Exact shock-free solution should have zero drag; but numerical integration of discretized surface pressures (of “exact” solution) gives C_d of 0.0005 (and C_l of 0.5949)!

- **Sensitivity of computed drag coefficient to numerical dissipation and grid density**

Numerical Dissipation Scheme ↓	Grid Density →	49 x 321	81 x 321	161 x 321	321 x 321
Standard Adaptive Dissipation (SAD)		0.000577	0.000294	0.00025	0.00027
Modified Adaptive Dissipation (MAD-1)		0.000464	0.000282	0.000241	0.000241
Modified Adaptive Dissipation (MAD-2)		0.000354	0.000245	0.000206	0.000207
Flux-limited Adaptive Dissipation (FAD)		0.000804	0.000505	0.000394	0.000367

Team (Euler) Validation

Canard-Wing-Body Configuration – Subsonic Flow (3D)

Canard-Wing Interaction Effect

168 x 84 x 34 H-H grid

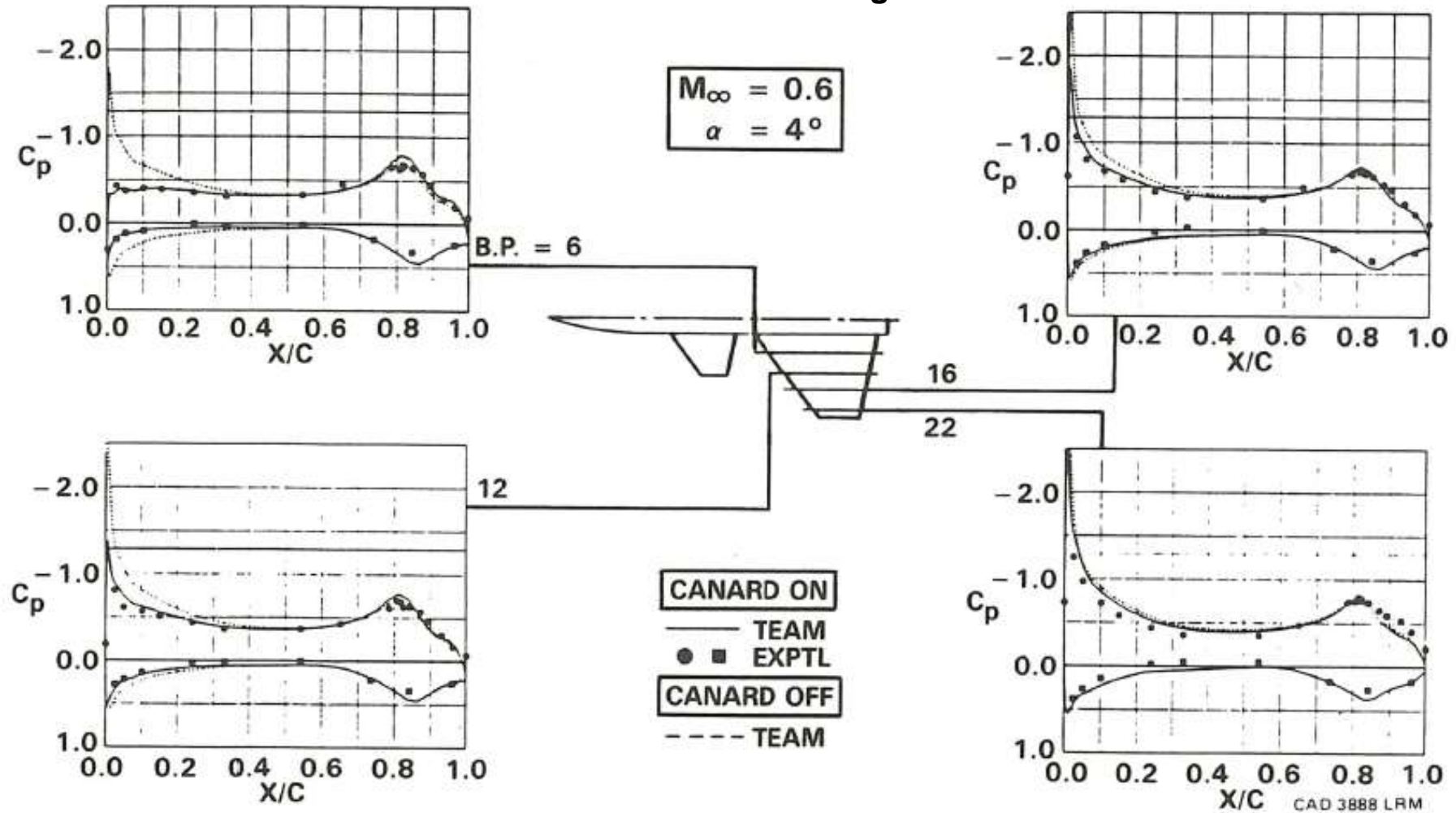

Team (Euler) Validation

Canard-Wing-Body Configuration – Transonic Flow (3D)

Canard-Wing Interaction Effect

168 x 84 x 34 H-H grid

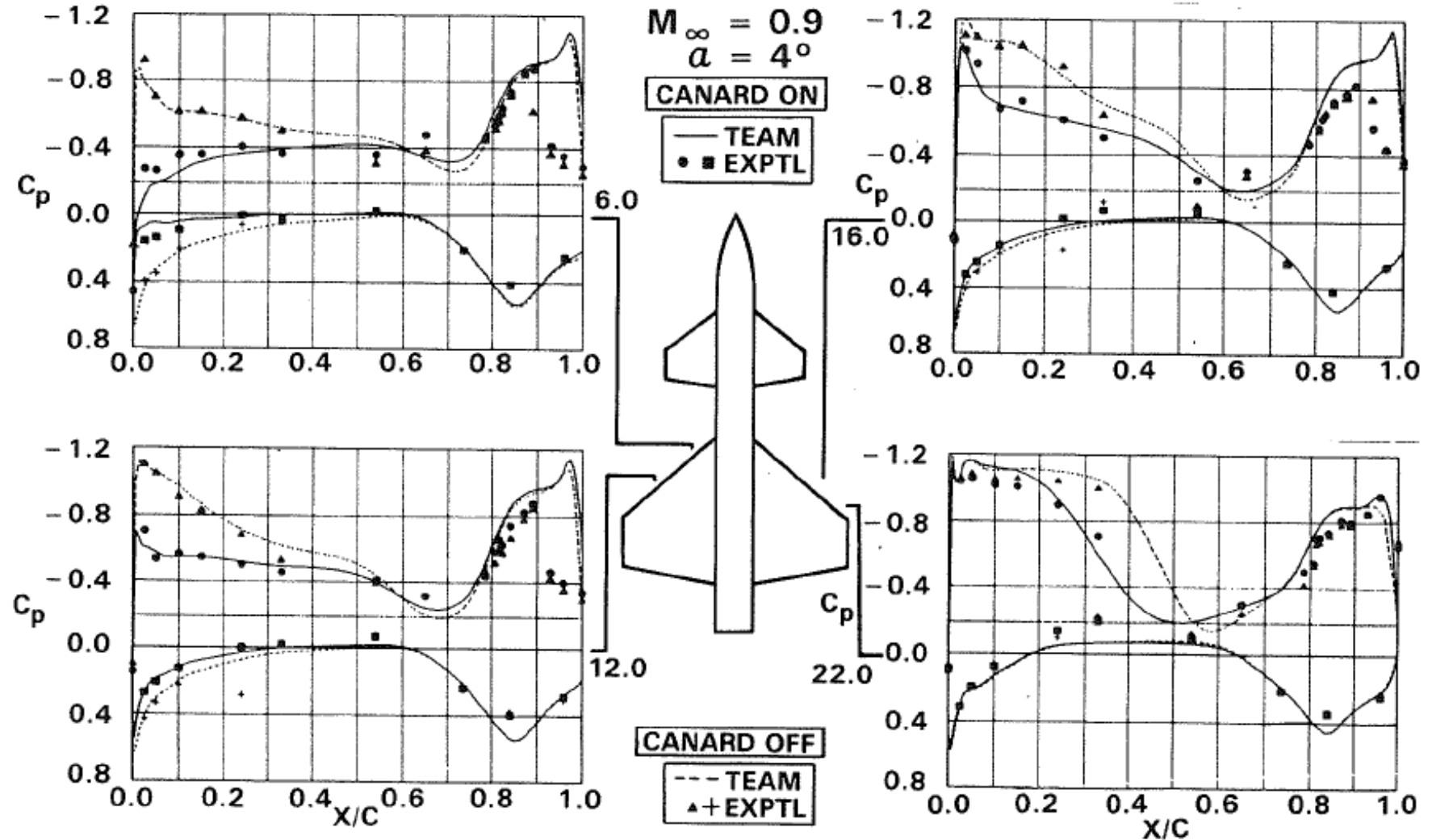

TEAM (Euler) Validation

Internal Flow – Three Test Cases

A. Axisymmetric Diverging Nozzle

$$a(x) = 1.398 + 0.347 \tanh(0.8x - 4) \quad \text{for } 0 < x < 10$$

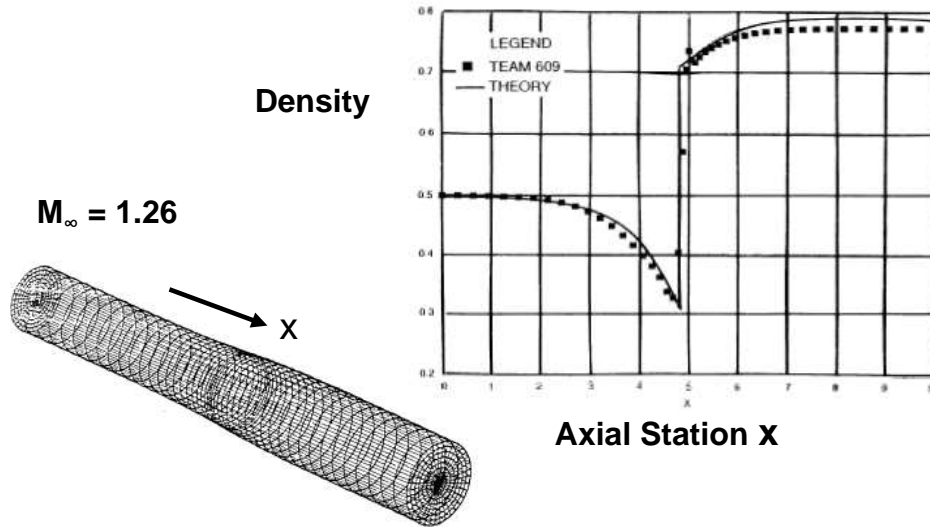

B. 1-D Inlet Duct Hammershock

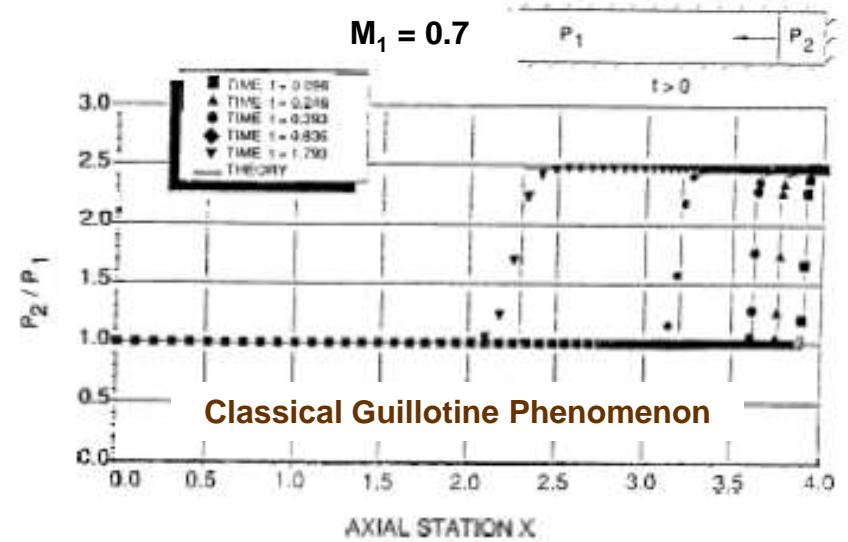

C. External Compression Mach 2.5 Axisymmetric Inlet

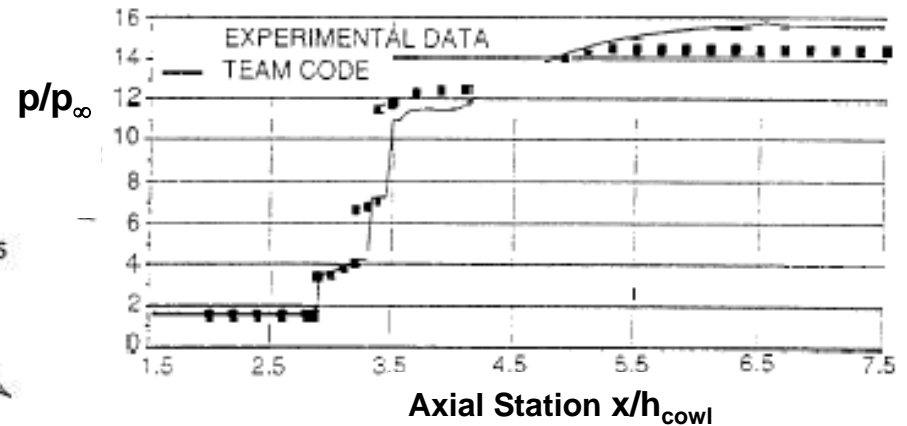
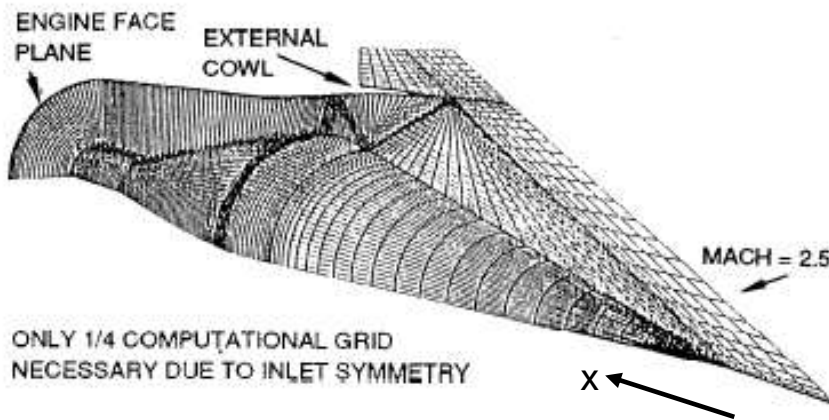

TEAM (Euler) Validation

Cone-derived Mach 6 Waverider – Hypersonic Flow

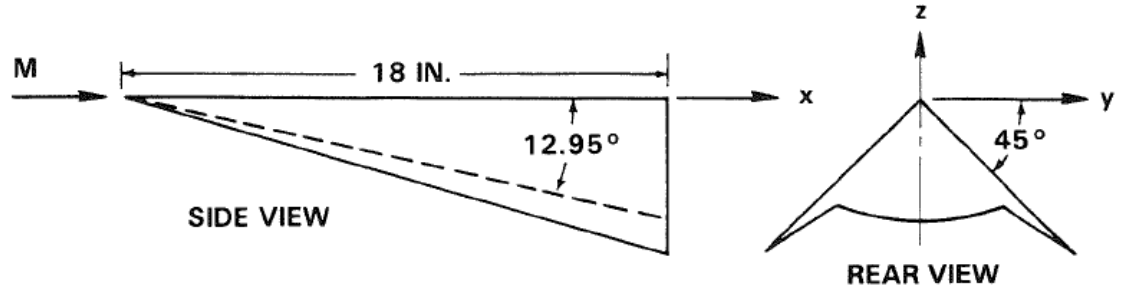
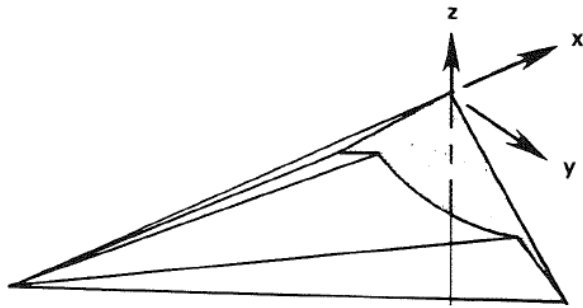

$M_\infty = 6, \quad \alpha = -4^\circ, 0^\circ, 4^\circ$

45 x 30 x 39 O-H Grid

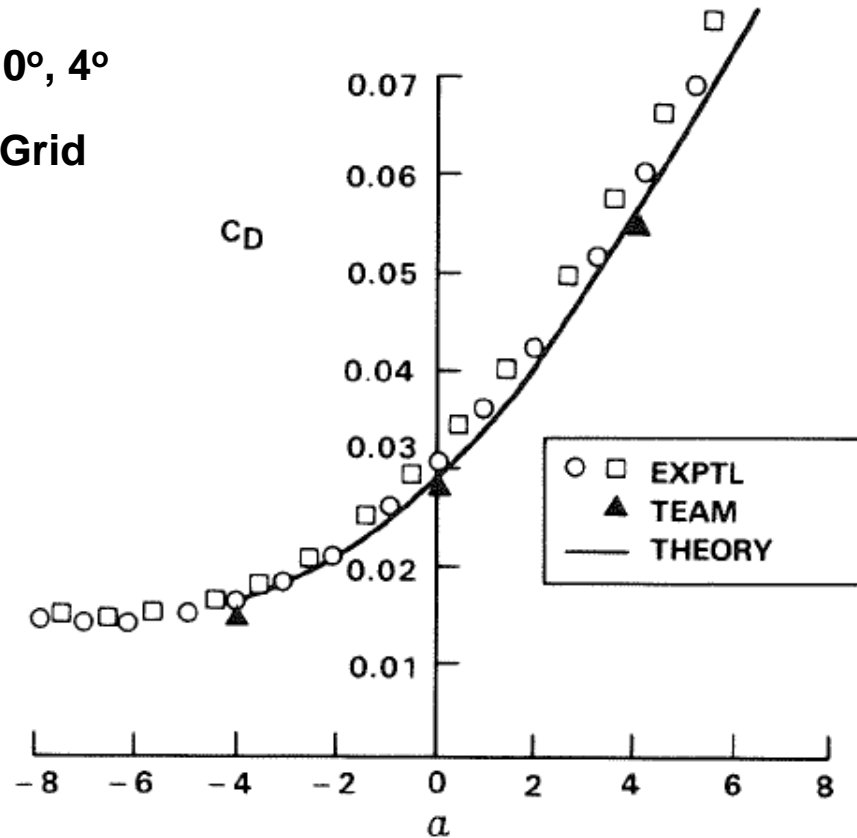
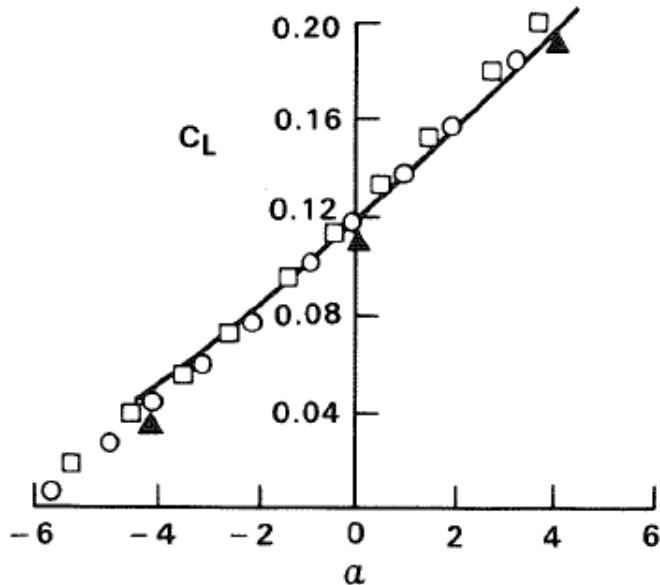

Free-vortex Flow Simulation Using Euler Codes

- **Eriksson and Rizzi (1981); Hitzel & Schmidt (1984); Murman & Rizzi (1986)**
 - Euler equation solutions on delta wing at 0.9 and 1.5 Mach numbers and $\alpha = 15^\circ$; free vortices captured automatically—1981 IV GAMM Conference
 - 1984: *Journal of Aircraft*, 21 (10); 1986: AGARD Symposium, Aux-Ed-Provence, France
- **Raj and Sikora (1984)—Recent Encounters with an Euler Code* (FLO-57GWB)**
Sharp-edged cropped delta wing ($M = 0.6$)

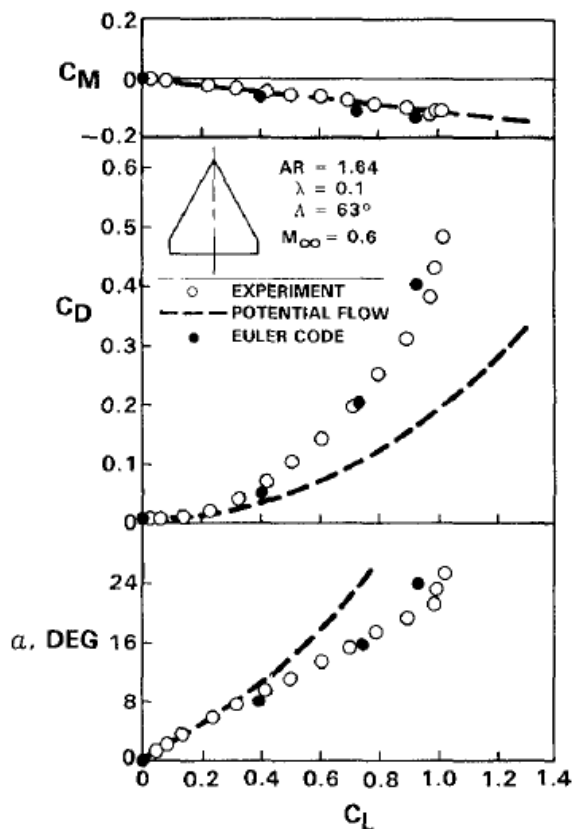

Arrow wing ($M = 0.85$)

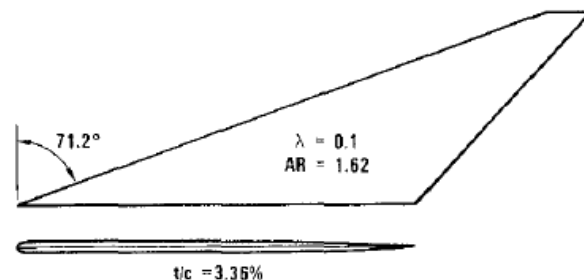
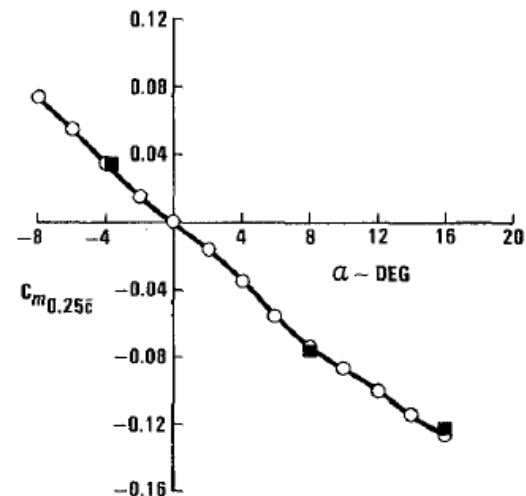
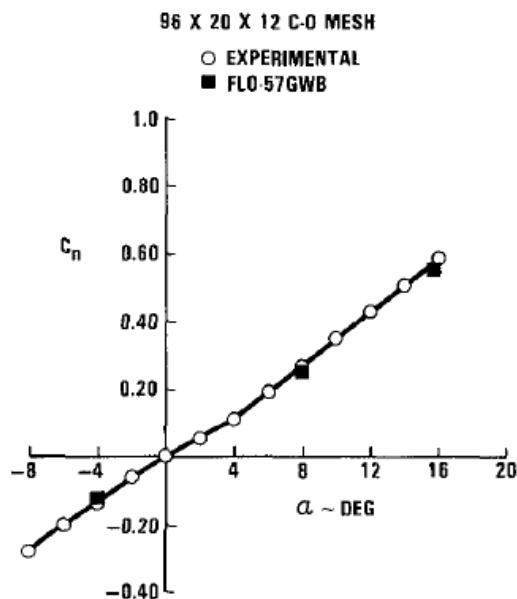

*inspired by Steven Spielberg's *Close Encounters of the Third Kind*—a 1977 American SciFi classic—he wrote and directed

Team (Euler) Validation

Strake-Wing-Body Configuration – Free-Vortex Flows

- Raj, Sikora and Keen (1986) - ICAS 86-1.5.2

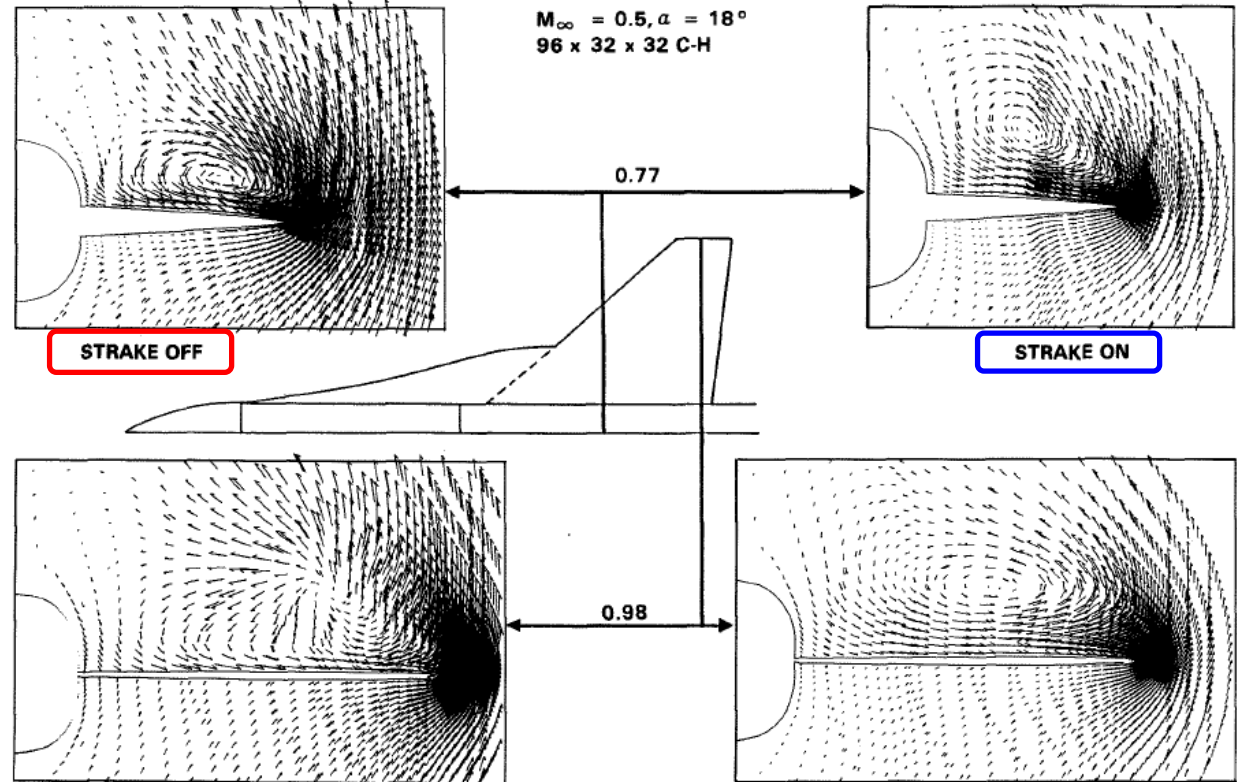
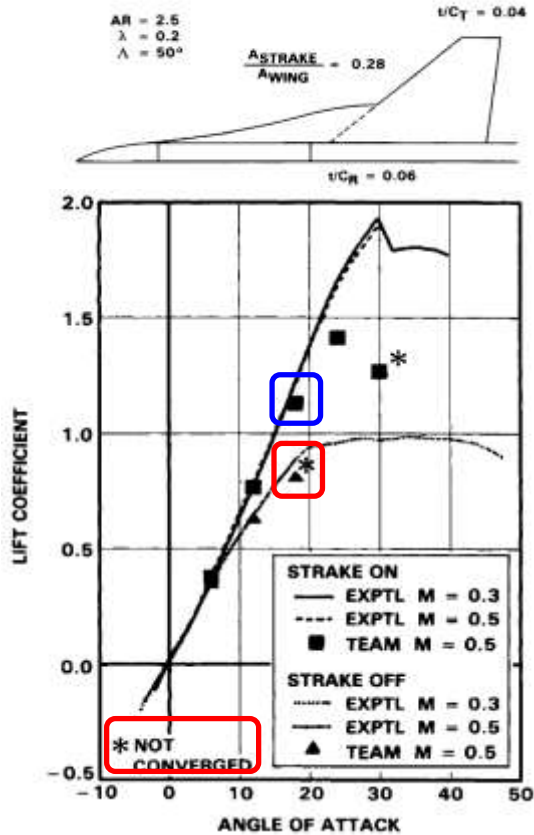

“...generation of vortices about sharp-edged wings due to the total pressure losses is quite insensitive to the actual magnitude of numerical dissipation, as long as there is some.”

Euler Codes More Effective Than The-then RANS Codes

Team (Euler) Validation

75°/62° Double-Delta Wing Body Configuration

Free-Vortex Flows

Raj, Keen, and Singer

AIAA paper 88-2517, 1988

$M_\infty = 0.3, \alpha = 20^\circ$

TEAM Computations
49 x 145 x 33 C-H Grid

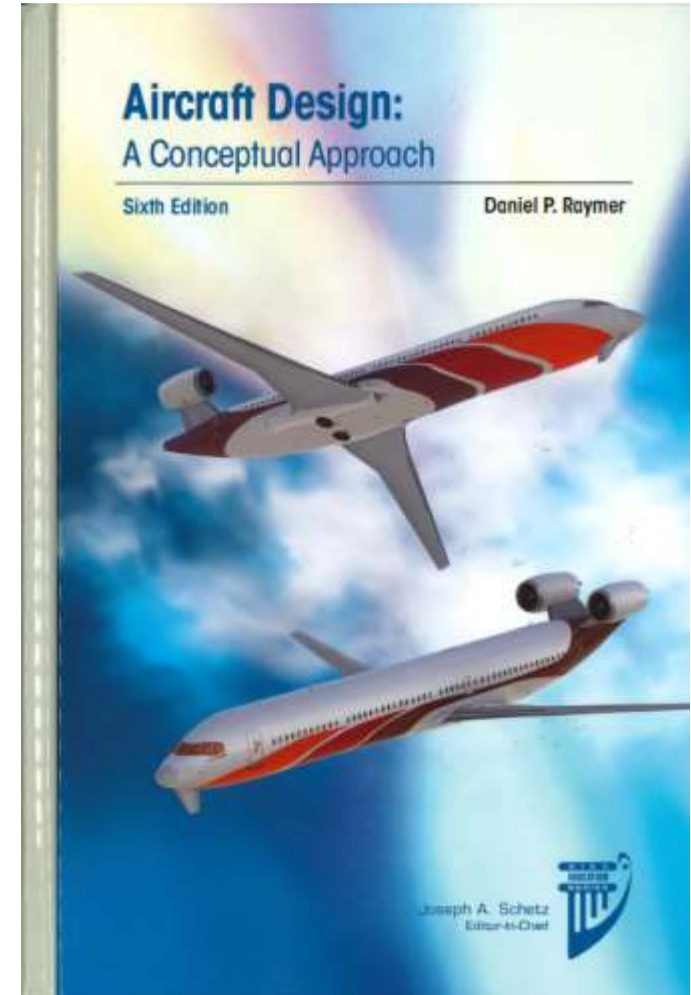
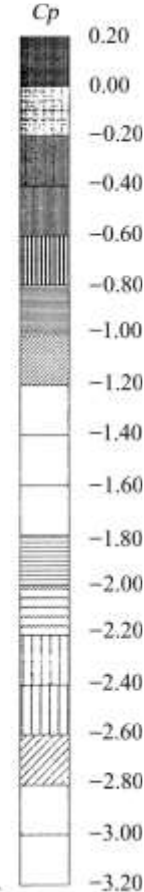
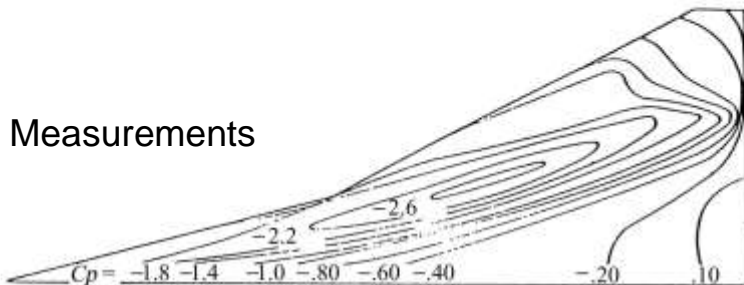
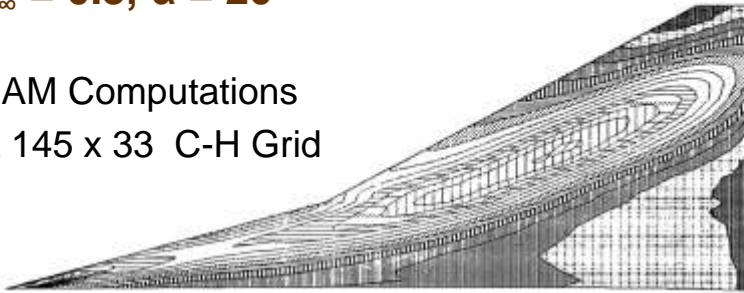

→ Fig. 12.42 (p 457)

“Recognition” by Aircraft Designer—Doesn’t Get Better Than That!

TEAM Capabilities: *Evolution Summary*

	<i>Configuration Geometry</i>	<i>Grids</i>	<i>Free-stream Mach number</i>	<i>Flow Model</i>
1984	<ul style="list-style-type: none"> •Wing •Wing-Body 	<ul style="list-style-type: none"> •Single Zone (Block) •C-H, C-O, O-O topologies 	Subsonic Transonic Supersonic	Inviscid (Euler)
1986	<ul style="list-style-type: none"> •Wing •Wing-Body •Wing-Body-Tail/Canard 	<ul style="list-style-type: none"> •Single Zone (Block) •C-H, C-O, O-O •O-H, H-H topologies added 	Subsonic Transonic Supersonic	Inviscid (Euler)
1988	<ul style="list-style-type: none"> •Wing •Wing-Body •Wing-Body-Tail/Canard •Full Aircraft with Inlet and Exhaust Systems 	<ul style="list-style-type: none"> •Single Zone (Block) •Patched Multi-Zone (Multi-Block) •C-H, C-O, O-O, O-H, and H-H topologies 	Subsonic Transonic Supersonic Hypersonic	<ul style="list-style-type: none"> •Inviscid (Euler) •Viscous (RANS with just Baldwin-Lomax Turbulence Model) •Equilibrium Real Gas

USAF/WRDC/Lockheed TEAM Code Offers Full Aircraft Aerodynamic Analysis Capability in 1988 for ATF (Inviscid Euler Much More Effective than Viscous RANS)

TEAM (Euler) Application: YF-22 Dem/Val

1988: Full-aircraft Analysis for Airloads Prediction (Reaser and Singer)

- Several transonic and supersonic Mach numbers
- Symmetric and asymmetric flight conditions
- Flow-through as well as powered nacelles

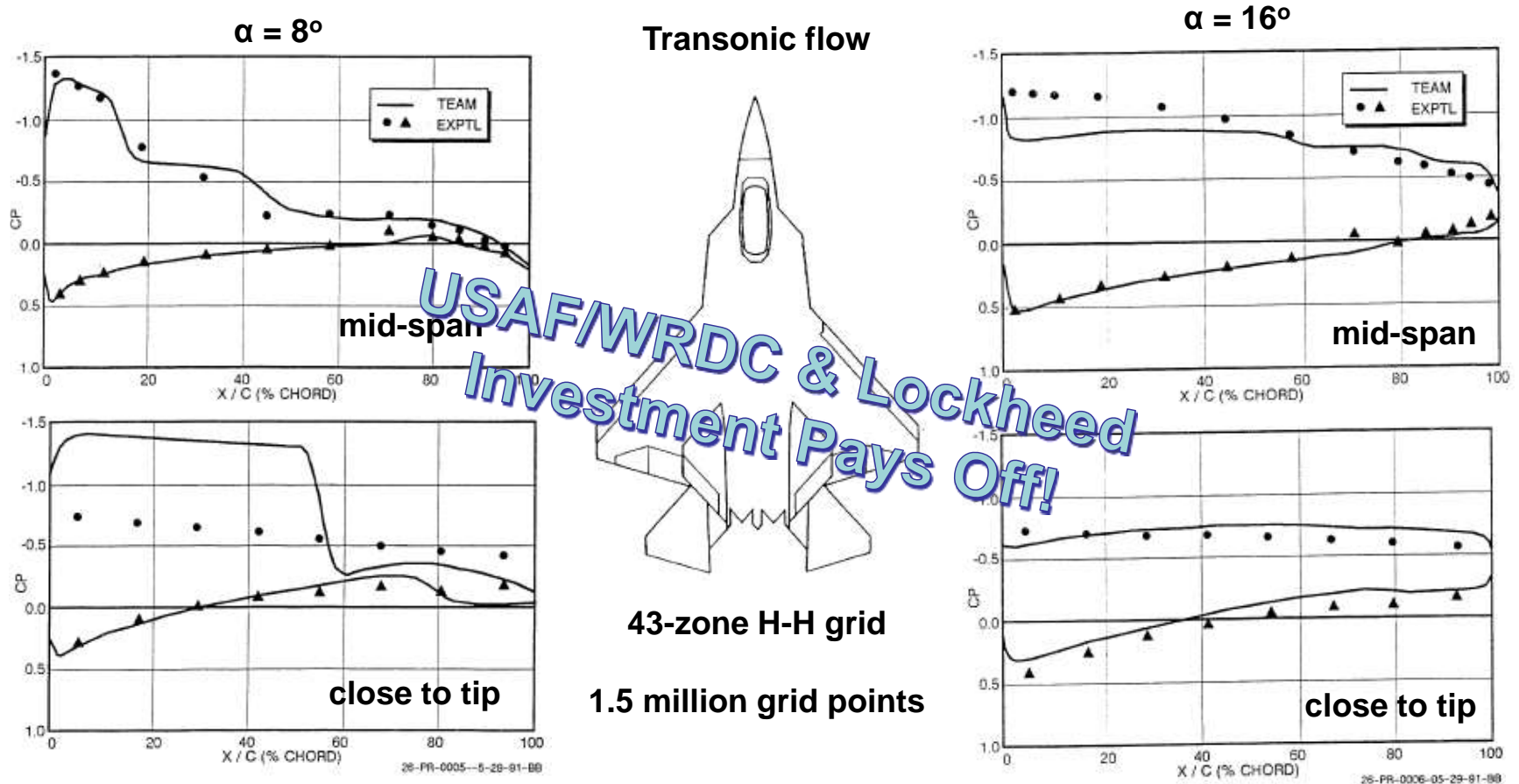

TEAM results generated before wind-tunnel pressure model test

Code used in *predictive mode**; no grid adjustments made for 'better/improved' correlations!

Computing Advances: *Key Enablers*

1975-1990: About 3 to 4 orders of magnitude improvement in speed and memory

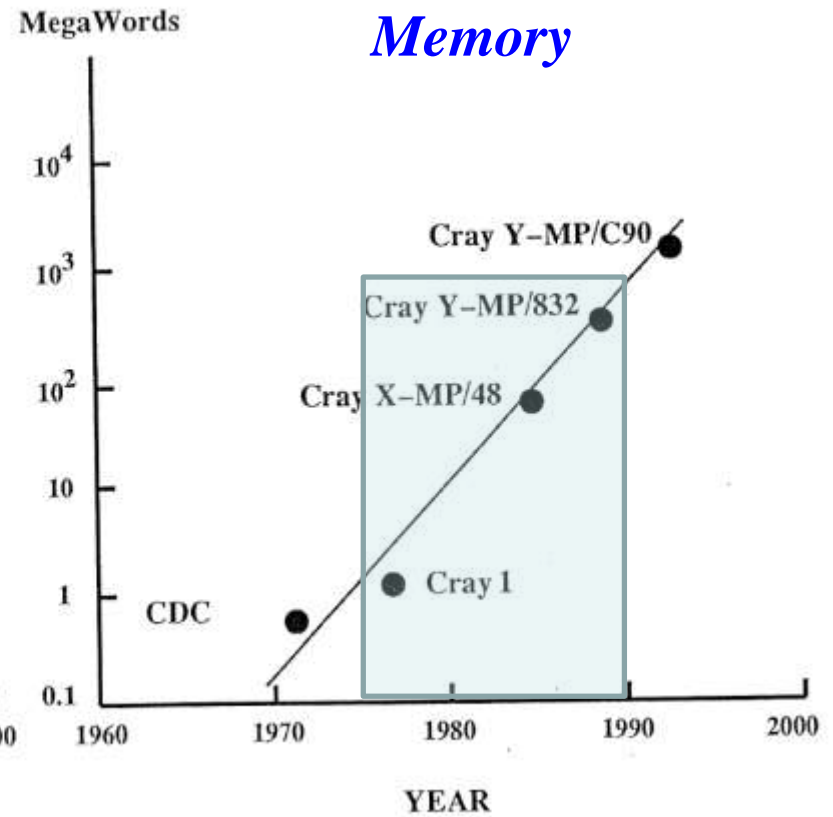
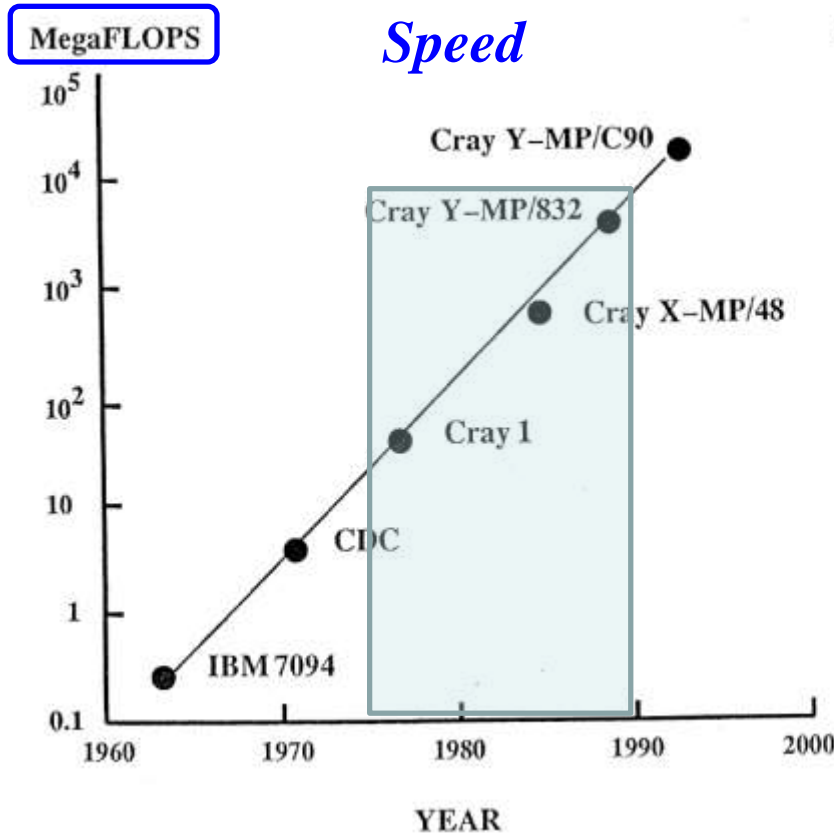

TEAM Computational Time

Cray Y-MP: 15 to 30 seconds per time step for a million cell grid

TEAM Computational Memory

Cray Y-MP: Approx. 40 times the maximum number of cells

By 1990, Euler Solutions on Million-cell Grid in 6 to 8 Hours...But Weeks of Grid-Generation Time Hampers Effectiveness!

TEAM (Euler) Application: YF-22 Dem/Val Effectiveness Assessment (1988-1989)

- **Long Turnaround Time:** Tedious and time consuming grid generation
 - Two engineers spent **few hundred man-hours** over **several weeks** to build a **43-zone H-H topology hexahedral grid** with approximately **1.5 million nodes** for half the configuration
- **Only Inviscid Drag:** Program personnel want total drag—not getting it is one of their key complaints

Lift reasonably well predicted for transonic flight conditions

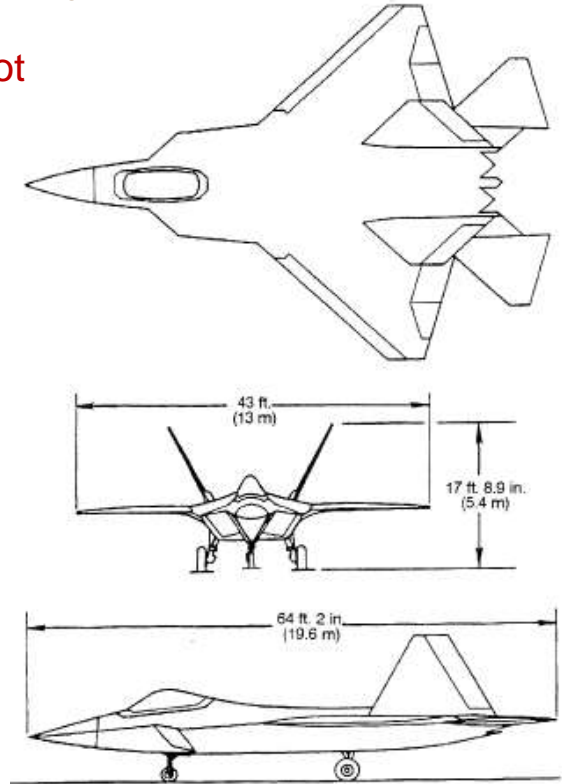
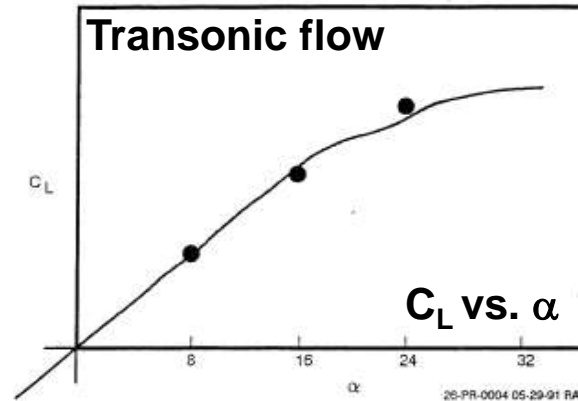

- **Detailed Surface Pressures Useful:** for structural design as well as thermodynamics groups
 - **Structural Design group** wants force, moment, and surface pressure **increments** due to control surface deflections

Challenge: Too Many Grids, Too Little Time!

TEAM Run Times 'Reasonable', but Effectiveness Too Low to Meet the Needs of F-22 EMD that Lockheed Hoped to win in 1991

Efforts to Increase TEAM Effectiveness

1989 – 1991

- **Total (Absolute) Drag:** *add viscous effects for increased realism*
 - Coupling with integral boundary-layer codes? *Not well suited for fighter analyses*
 - Extend TEAM by adding N-S viscous terms? *In-house TRANSAM efforts initiated in 1986*
- **Grid Generation:** *make it faster and less labor-intensive*
 - Multi-block hexahedral grids
 - Overlapping grids
 - Cartesian grids
 - Unstructured tetrahedral grids

- **AIRPLANE Code:** Lockheed procured unstructured tetrahedral grid Euler code in 1990 from Jameson's Intelligent Aerodynamics, Inc., Princeton, NJ



Key Challenge:

How to develop requisite level of competency and confidence in a brand new code in order to lower the risk enough by early 1991 for F-22 EMD applications?

In 1990, aerospace industry went into depression leading to (a) reduction in the number of qualified engineers, and (b) significant cuts in R&D funding!

- **Interim Path Forward:** make maximum use of multi-zone structured grid—*once it's built*—as structured grid generation methodology was the most mature at that time
 - *Use surface transpiration concept to “simulate” the effect of control surface deflection by appropriately changing the no-normal-flow surface boundary condition*

Innovative Approach to Estimating Incremental Loads Due to Control Surfaces

- **Customer's Problem:** Estimate incremental aerodynamic forces, moments, and surface pressures due to control surface deflections for multiple settings and flight conditions to support structural design
- **Solution:** Use *surface transpiration concept* to “simulate” the effect of control surface deflection by appropriately changing the no-normal-flow surface boundary condition
 - NO NEED TO CHANGE THE INITIAL GRID!
 - The concept—originally proposed by Lighthill—had enjoyed great success in simulating the effect of boundary layer on inviscid flow modeled using potential or Euler methods

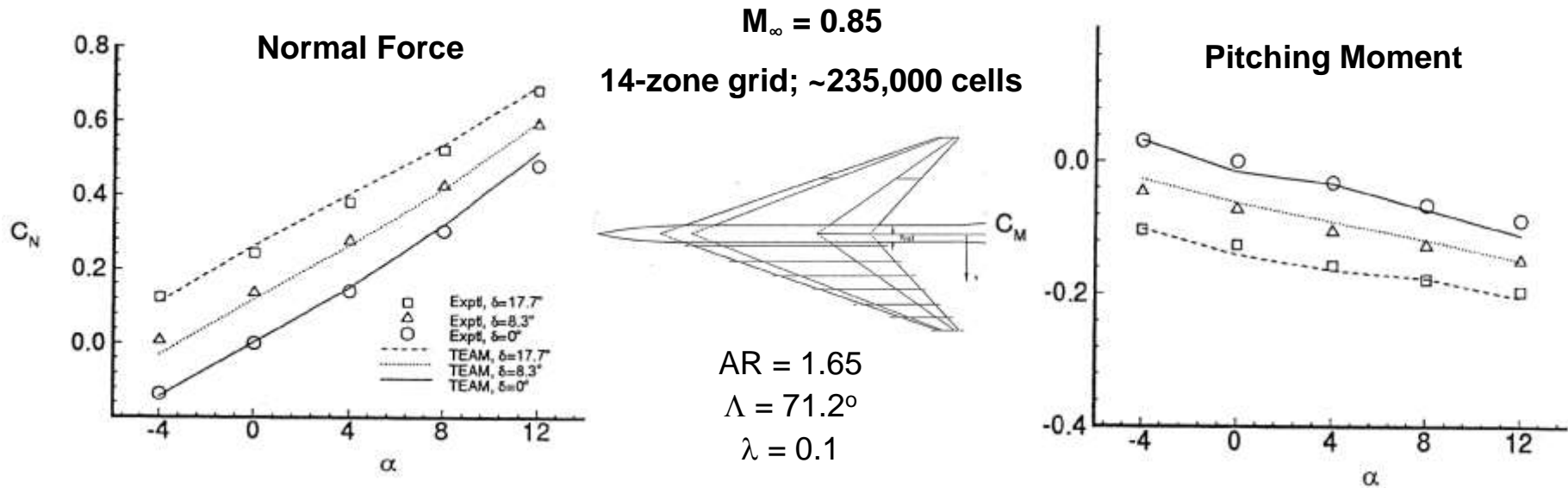

Solution developed and implemented in 1989-90; published in 1993, AIAA Paper 93-3506

Results Contributed to 'Customer Confidence'

The Exciting Eighties!

- **April 12, 1981: Launch of the First Space Shuttle Mission**
 - Mission Commander **John Young** had already flown in space four times, including a walk on the Moon in 1972
 - **Bob Crippen**, the pilot, was a Navy test pilot who would go on to command three future shuttle missions
- **June 1981: USAF ATF Request for Information (RFI)**
- **September 26, 1981: Boeing 767 First Flight**
 - September 8, 1982: original 767-200 entered service with United Airlines
 - October 1986: 767-300 followed by 767-300ER in 1988
- **February 19, 1982: Boeing 757 First Flight**
 - January 1, 1983: original 757-200 entered service with Eastern Airlines
 - Compared with 707 and 727, it consumed approx. 40% less fuel per seat, on typical medium-haul flights
- **December 14, 1984: Grumman X-29 First Flight**
 - Experimental aircraft that tested forward-swept wing, canard control surfaces, and other novel technologies
- **September 1985: USAF ATF Request for Proposal (RFP)**
- **October 1986: Lockheed and Northrop Awarded 50-month Prototype Dem/Val Contracts**
 - First Flights: YF-22 (29 Sep 1990); YF-23 (27 Aug 1990)
- **February 22, 1987: Airbus 320 First Flight**
 - 18 April 1988: entered service with Air France



The Exciting Eighties (for the Author!)

Personal

1980

- **Granted US Permanent Resident status**
- **And...**



1981
1st son

1985
2nd son

1985
Naturalized US Citizen

Professional

- **AIAA & SAE**
 - AIAA ASM: St. Louis (1981), Reno (1983, 1984, 1987)
 - AIAA APA: Danvers (1983), Williamsburg (1988)
 - AIAA Euler Solvers Workshop: Monterey (1987)
 - SAE Aerospace Tech Conf. & Expo: Anaheim (1988)
 - Two AIAA Technical Committees: *Fluid Dynamics* (1985-88) and *Applied Aerodynamics* (1988-91)
- **ICAS* Congress**
 - Toulouse (1984), London (1986), Stockholm (1990)
- **3rd Intl. Congress of Fluid Mech., Egypt** (1990)
- **After-hours teaching (1985-1990)**
 - Lockheed Employee Edu. Pgm. (*Aerodynamics for Designers*)
 - UCLA Continuing Education (*Introduction to Aerodynamics*)
 - Lockheed Tech Institute (*Computational Fluid Dynamics*)
- **Lockheed consolidation (1987)**
 - **Three companies into one: Lockheed Aeronautical Systems Company (LASC) headquartered in Burbank, California**
 - **Loss of CFD and ACA talent and expertise in Georgia**
- **Appointed Comp Aero Technical Lead (1989)**
 - Represented LASC on Corporate Task Force on Advanced Computing Methods (ACM)

*International Council of the Aeronautical Sciences

The Exciting Eighties (for the Free World)

Final Collapse of the USSR & Emergence of the New World Order



A Pivotal Event in World History: November 9, 1989



Fall of Berlin Wall Created New Geo-political Realities

The Nasty Nineties Followed the Exciting Eighties!

- **“Peace Dividend”—Major Contributor to Depression in US Aerospace Industry**
 - Loss of 495,000 people (37% of workforce) in just five years (1990-1994)
 - Overall sales down 9% in 1994 after single-year 10% drop in 1993
 - Dramatic reductions in Research & Development funding in aerospace industry
- **Consolidations, Mergers, and Reorganizations—To Reduce Capacity & Cost**
 - Dec 1992: Lockheed acquires General Dynamics military aircraft division
 - Mar 1995: Lockheed and Martin Marietta formally merge
 - Dec 1996: Boeing and McDonnell Douglas announce merger

Grumman
Westinghouse*
Northrop

Texas Instruments*
Raytheon*
E-Systems
GM Hughes*

General Dynamics*
Loral
GE Aerospace
Martin Marietta
Lockheed

McDonnell Douglas
Rockwell*
Boeing

*aerospace defense unit

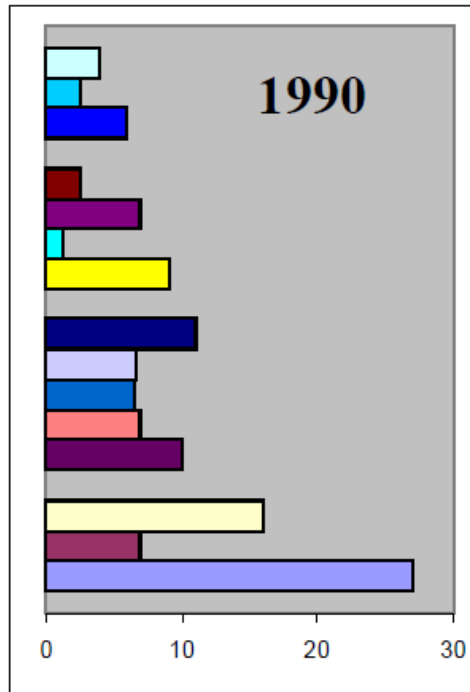

(size of the bar represents sales volume)

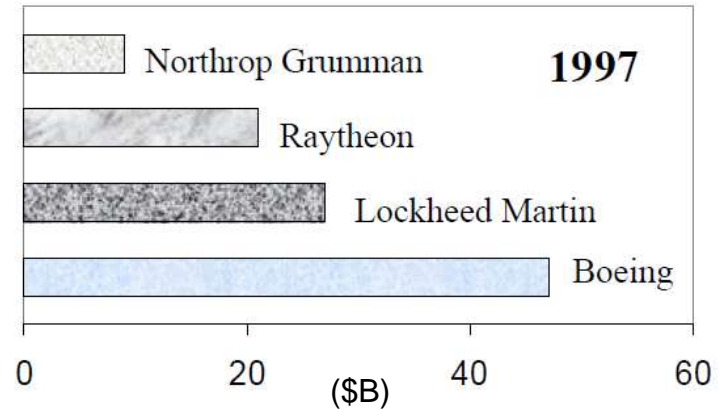

- Reduce Excess Capacity
- Reduce Overhead Costs

15 down to 4 in 7 years!

New Opportunities: *Early 1990s*

- **May 1990: Lockheed Reorganization—*one company into two!***
 - Decides to vacate Burbank—split operations between Palmdale and Marietta
 - Lockheed Advanced Development Company (LADC), Palmdale, California
 - Lockheed Aeronautical Systems Company (LASC), Marietta, Georgia
- **23 April 1991: *YF-22 is the winner!***
 - Secretary of the US Air Force Donald Rice announced Lockheed's **YF-22** as the **winner**
 - LASC to work the F-22 Engineering and Manufacturing Development (EMD) contract in Georgia
 - ***Raj relocates to Georgia in August 1991***
- **13 December 1991: *LASC selects two Technical Fellows in the inaugural year***
 - **Chellman (Structures) & Raj (CFD)**
 - Most Senior Rank in Technical Track
 - Increased Emphasis on Mentoring and Technical Leadership
 - **Key Challenge: Rebuild Capabilities in Georgia**



Raj's Tech Fellow Mission Spurred by "A Jolt of Reality"

- **Engineer's Week Celebration, San Fernando Valley, California (23 February 1991)**
 - Conversation over cocktails about CFD and YF-22
 - Caren asks: *How many more "design cycles" on YF-22 could we do because of [higher level] CFD?*
 - The answer: **ZERO!**
- **As Tech Fellow, Raj embarks on a mission in 1992 to better understand and address issues related to **CFD effectiveness for aircraft design****

- **1993–1997: AIAA Multi-disciplinary Design Optimization (MDO) TC member**
- **1994: US Multi-disciplinary Aerodynamic Design Environment (US-MADE)**
Proposal to DARPA by Jameson (IAI–Lead), Gregg (Boeing), Raj (Lockheed); *not funded*
- **1997: CFD at a Crossroads: An Industry Perspective (Invited)**, *Thirty Years of CFD and Transonic Flow* Symposium to honor Prof. Earl Murman on his 55th Birthday, Everett, WA [also in *Frontiers of Computational Fluid Dynamics*, Caughey & Hafez (eds.), 1998, pp. 429-445]
- **1998: Aircraft Design in the 21st Century: Implications for Design Methods (Invited)**, AIAA Paper 98-2895, 29th AIAA Fluid Dynamics Conference, Albuquerque, NM
- **2007: Computational Uncertainty: Achilles' Heel of Simulation Based Aircraft Design (Invited)**, NATO/RTO Air Vehicle Technology (AVT) Symposium, Athens, Greece

Robert P. "Chris" Caren



Exec. VP, Sci. and Engineering
Lockheed Corp.
25 Dec 1932 – 3 Jul 2017

TEAM (Euler) Application: F-22 EMD (1991)

Full-aircraft forces, moments and airloads prediction (Kinard & Harris)

- **42-zone grid, 1.25 million nodes** (for half the configuration)
 - ✓ Grid built using AFRL GRIDGEN in 6 weeks from CATIA design loft
- **370 airloads cases; 3 months; 1600 CPU hours* on Cray-Y/MP 2/16**
 - ✓ Six Mach numbers (0.6 to max speed)
 - ✓ Angles of attack: - 4° to +24°; Side-slip angles: 0° to 5°
 - ✓ Leading and trailing-edge flaps, horizontal tail, and rudder deflections

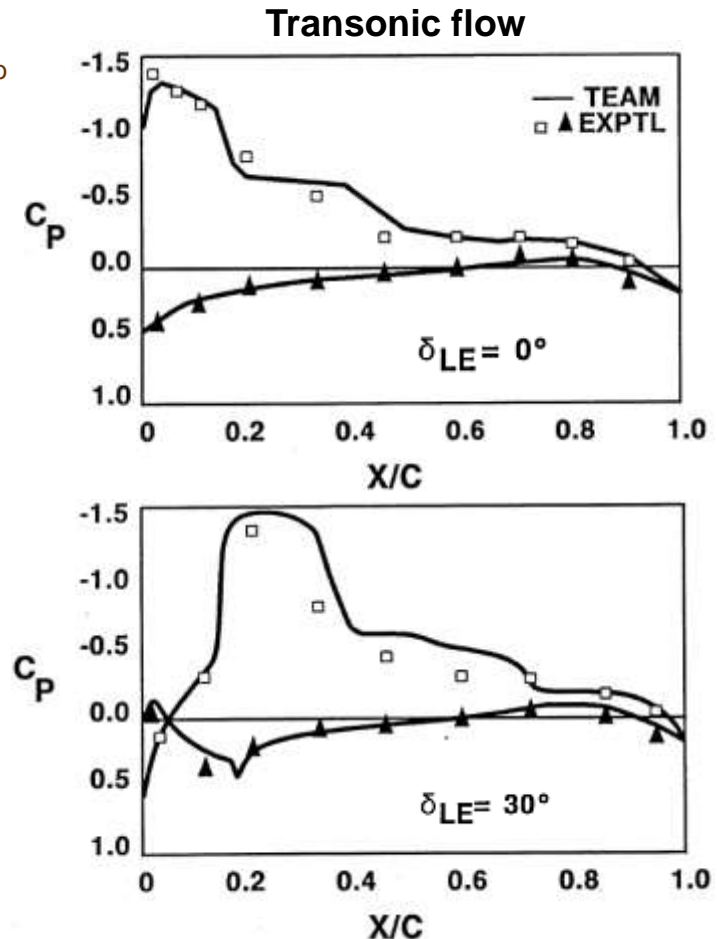
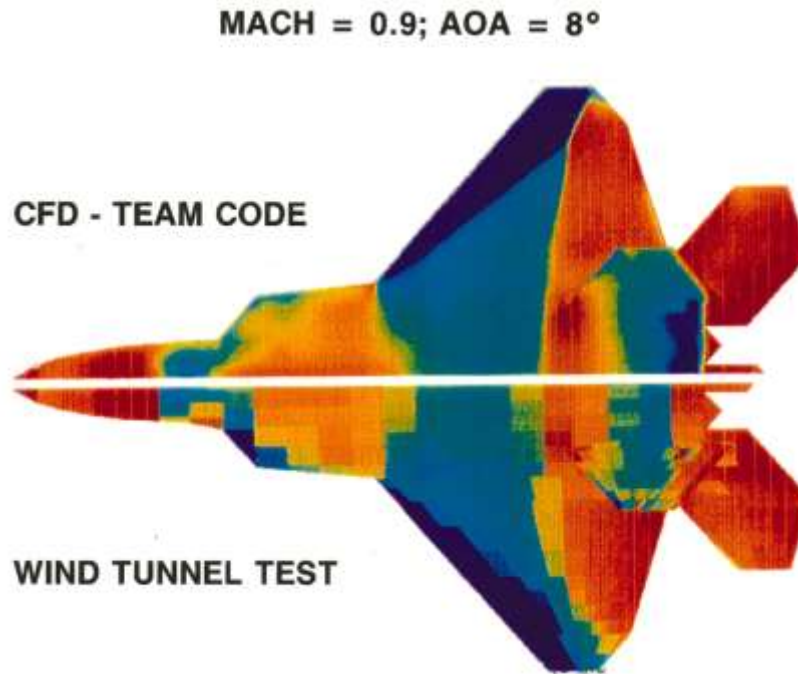

\$40M Estimated Cost Avoidance

**Equivalent to 24 hours a day, 5 days a week, for 13 weeks! Probably an industry record at that time.*

Inlet Hammershock Simulation

- **Grid:** Built (for half the configuration) using AFRL GRIDGEN on geometry from CATIA design loft
 - **External geometry:** 49-zone grid with 1.535 million nodes
 - **Internal (inlet) geometry:** single-zone grid with 259,200 nodes
- **Time-accurate analyses:** performed using YF119 engine face surge overpressure waveform for three Mach numbers: 1.2, 1.5 and 1.7
- **Simulations used NASA NAS Cray C-90**
 - 35 sec/time step; step size 1.4 μ s

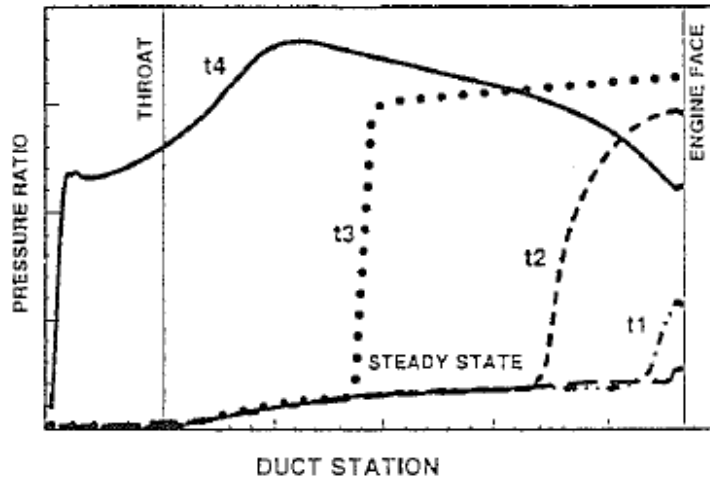
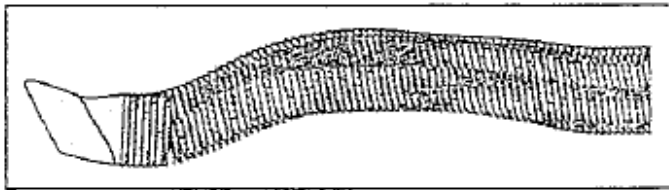

Computed pressure loads replaced those from less-sophisticated analyses leading to significant weight savings

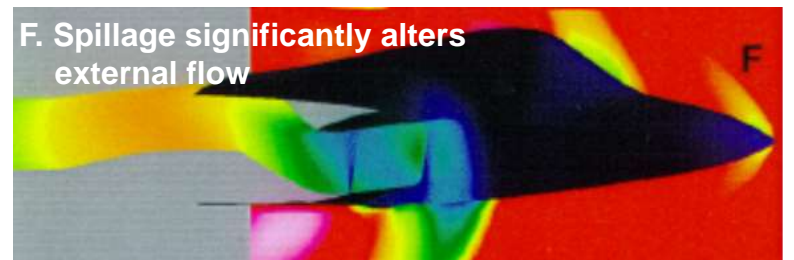

Demonstrated for Wide Range of Geometries & Flow Conditions

Typical Example: Supersonic-Cruise Vehicle with Over/Under Engine Arrangement

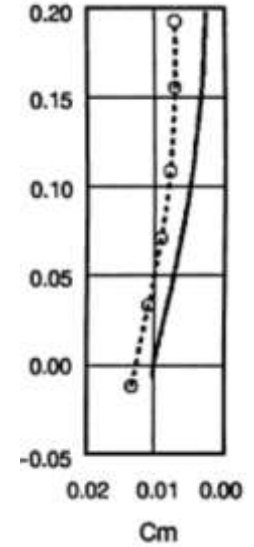
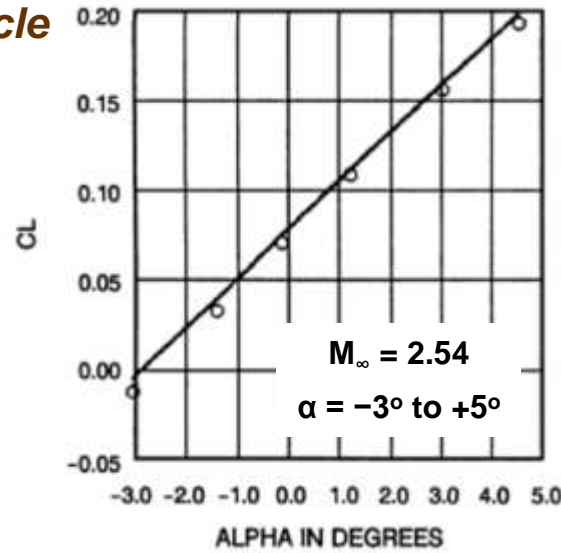
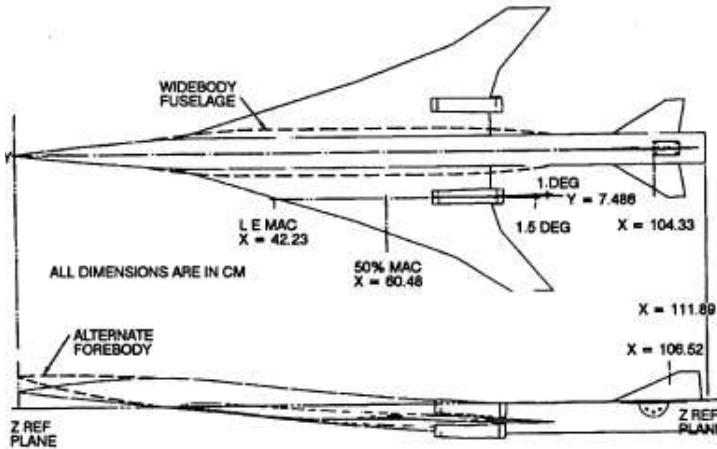

Grid: 10-Zone H-O topology; 185,520 Cells

Lift Values Well Predicted, Moment and Total Drag Not So Well...But Trends Captured Well!

Two Key Issues Hamper Effectiveness: Long Grid Generation Times and Lack of Viscous Effects

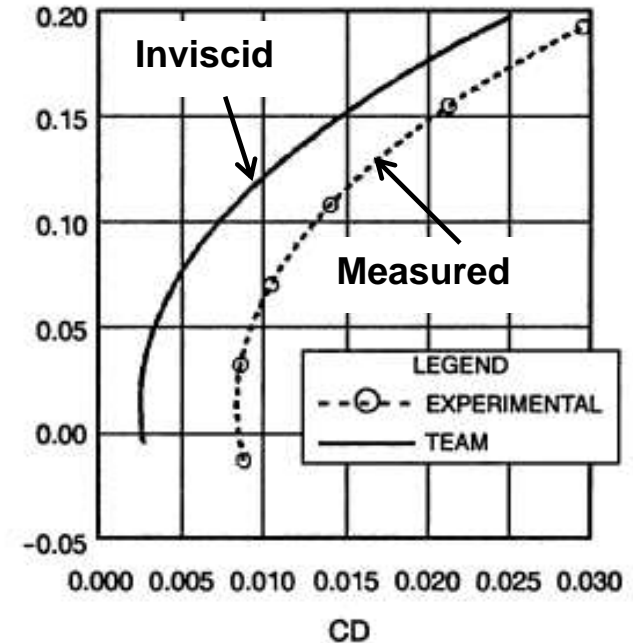

Lockheed Addresses Grid Generation Issue 1990s

Explore potential benefits of unstructured grids by participating in studies sponsored by Dr. Jim Luckring, NASA-LaRC (1993-1996)

- **NASA Study Objective:** To assess capabilities and limitations of rapidly evolving unstructured-grid Euler methods for preliminary design applications
- **Kinard and Harris, *Evaluation of two unstructured CFD methods—AIAA Paper 94-1877***
 - ✓ **AIRPLANE** code (Meshplane and FLOPLANE)
 - ✓ **TetrUSS** code (Vgrid and USM3D)
 - ✓ Three test cases: 74° delta wing; Wing C; and Arrow wing-body
 - ✓ Needs for improvement identified
- **Kinard, Finley and Karman, *Prediction of compressibility effects using unstructured Euler analysis on vortex dominated flow fields—AIAA Paper 96-2499***
 - ✓ **SPLITFLOW** code (Cartesian grids)
 - ✓ **TetrUSS** code (Vgrid/USM3D)
 - ✓ Compressibility increments predicted well for forces, but not for moments
 - ✓ More details in NASA CR 4710 and CR 4711

	Memory (words/cell)	CPU time $\mu\text{s}/\text{cell}/\text{cycle}$
FLOPLANE	34	11
USM3D	45	18

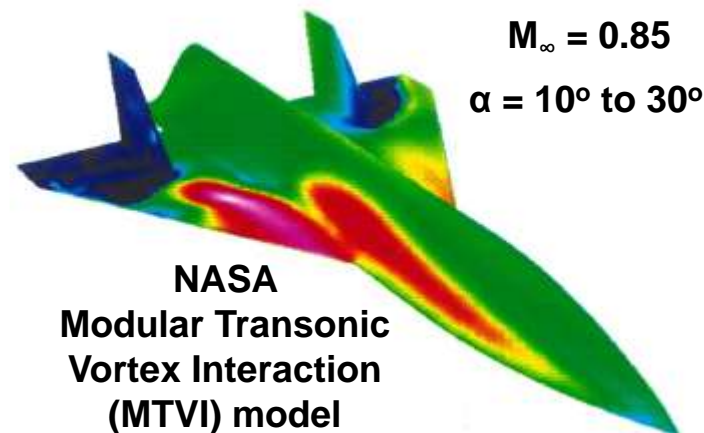

**All Unstructured Grid Methods
More Effective than TEAM!**

Level IV RANS Methods 1990s - present

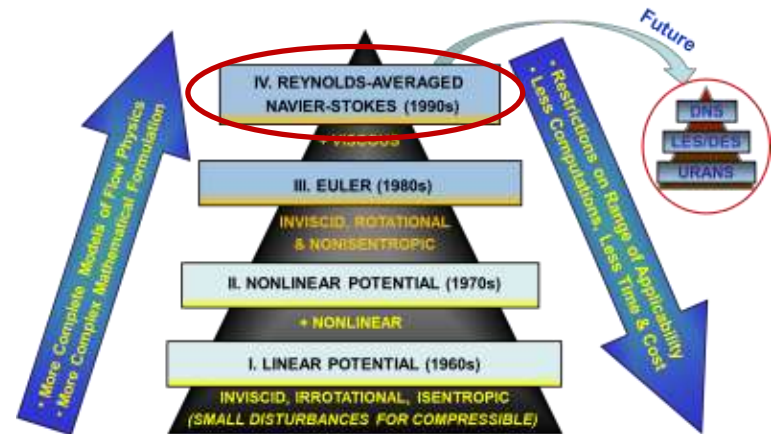

Flow Model

$$Q_t + F_x + G_y + H_z = Re^{-1} (R_x + S_y + T_z)$$

$$Q = (\rho, \rho u, \rho v, \rho w, \rho E)$$

- Laminar flows—Navier-Stokes equations; no assumption (other than continuum)
- Turbulent flows—Reynolds-Averaged Navier-Stokes (RANS) equations
 - ✓ Turbulence models of nonlinear Reynolds stress terms needed for closure

Applicability

- All Mach numbers and all flow configurations

- **Olling, Raj, and Miranda (1986)**

- Initiated **TRANSAM*** (*Three-dimensional Reynolds-Averaged Navier-Stokes Aerodynamic Method*) development by extending TEAM Euler solver to RANS equations; TRANSAM served as a testbed for turbulence models
 - ✓ Zero, one- and two-equation turbulence models incorporated; all with fixed transition location

- **Raj, Olling and Singer (1988)**

- **TEAM** renamed (*Three-dimensional Euler/Navier-Stokes Aerodynamic Method*) with ability to perform either Euler or RANS analyses
- Applied to many test cases: results for airfoils, wings, and full aircraft in **ICAS-90-6.4.4** and **IPAC 911990**

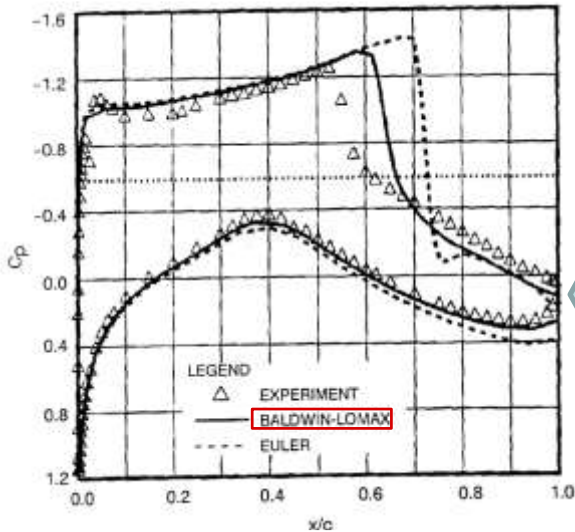

RAE 2822 (AGARD Case 10)

$M_\infty = 0.75, \alpha_{\text{corrected}} = 2.81^\circ$

$Re = 6.2 \times 10^6$

129 x 257 C Grid

Baldwin-Lomax algebraic turbulence model

Johnson-King half-equation turbulence model

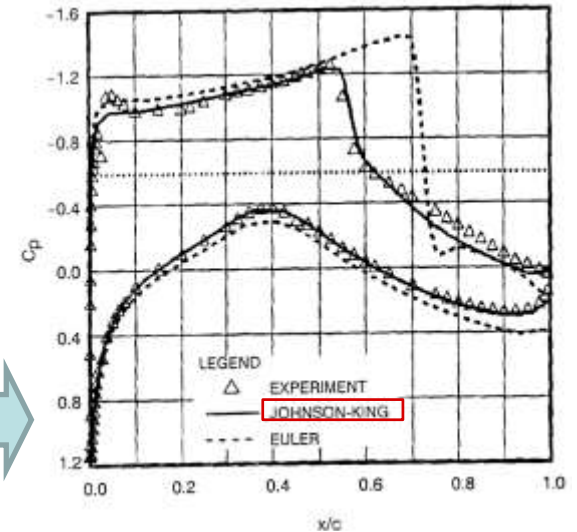

Simulation of shock/boundary-layer interaction improves realism

- **Goble, Raj and Kinard (1993)**

- USAF Wright Labs TEAM Version 713 User's Manual—**WL-TR-93-3115**
- Many improvements along with Baldwin-Lomax and Chien k- ϵ turbulence models

TEAM (RANS) Validation

Transonic Flow (2D)

AGARD Test Case 10: RAE 2822 Airfoil

$$M_\infty = 0.75, \alpha = 2.8^\circ, Re_c = 6.2 \times 10^6$$

129 x 257 C Grid

$y^+ < 1$ in cells next to the surface

Surface pressure distribution

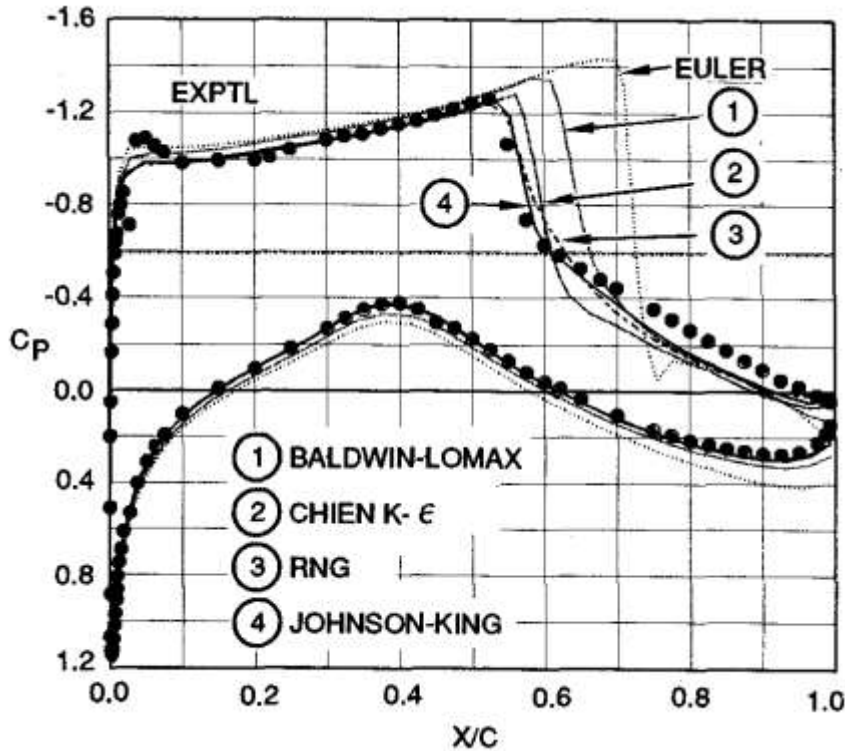

Skin friction coefficient distribution

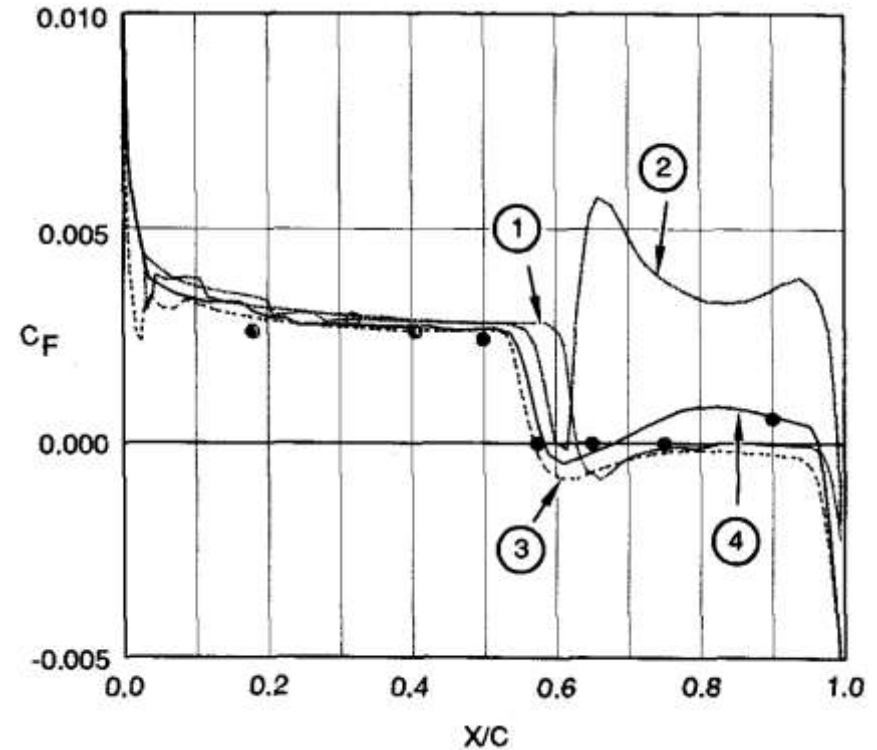

Solution Exhibits Sensitivity to Turbulence Models

TEAM (RANS) Validation

Transonic Flow (3D)

AFOSR-Lockheed Wing C: Surface Pressure Comparisons

7 zone C-O grid (51 x 257 x 35)

Baldwin-Lomax turbulence model

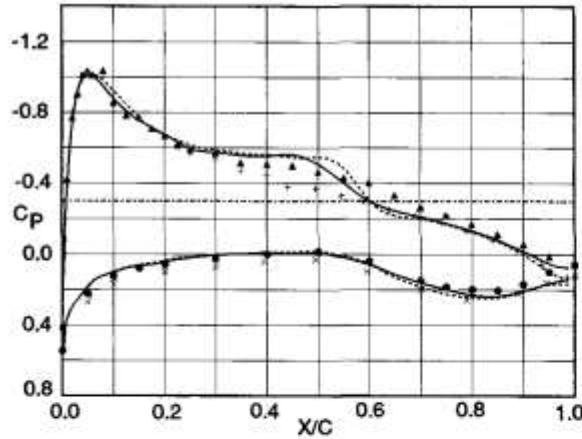

$M_\infty = 0.85$
 $\alpha = 5^\circ$
 $Re_{mac} = 10 \times 10^6$

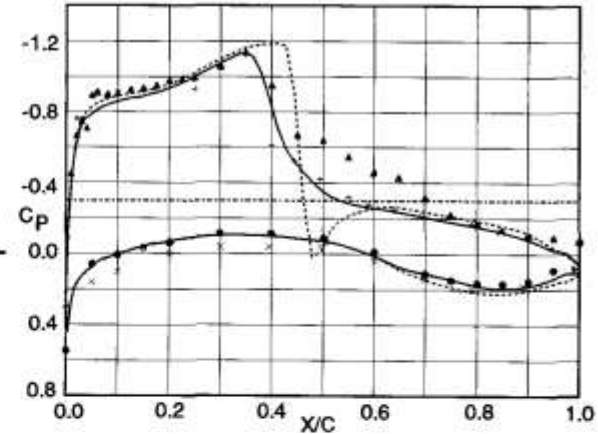

Viscous (RANS) analysis: 6 inner zones
Inviscid (Euler) analysis: 1 outer zone

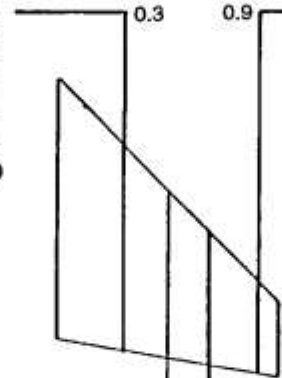

▲ ● Large-scale test
+ × Small-scale test

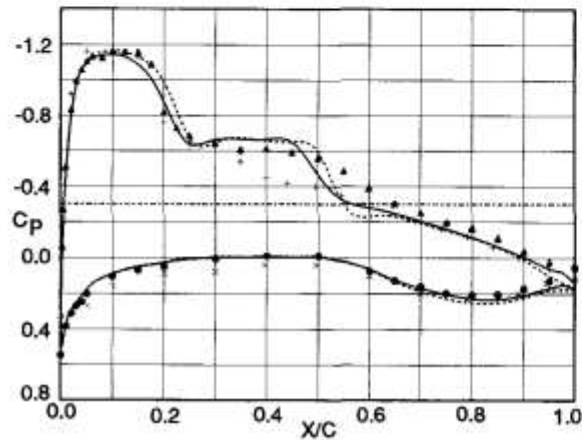

— TEAM (VISCOUS)
- - - TEAM (INVISCID)
▲ ● EXPTL [32]
+ × EXPTL [33]

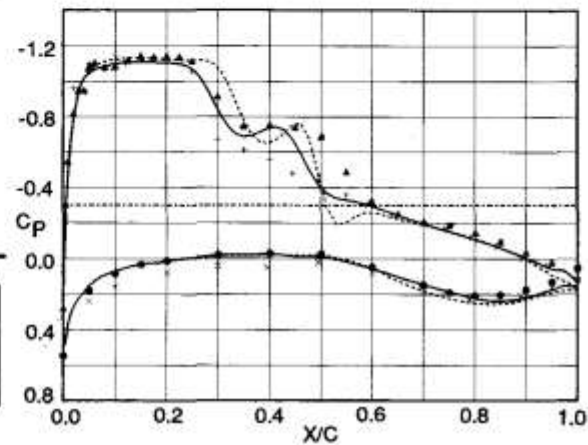

TEAM (RANS) Effectiveness (early 1990s)

In spite of improved 'quality' of simulated results, achieving high levels of Effectiveness for the RANS version of TEAM remained elusive due to

- (a) labor-intensive and time-consuming process for structured grid generation about full aircraft configurations, and***
- (b) the use of expensive high performance computing for acceptable turnaround times.***

Goal (set in early 1990s)

Less than 24 hour RANS aero analysis turnaround without increased cost by 2000!

Strategy

- Automated grid generation***
- Affordable high performance computing***

Out with TEAM, In with TetrUSS!

(Later half of 1990s)

- **TetrUSS Software: A Modular System Developed by NASA-LaRC**
 - GridTool—Graphical User Interface (GUI) for surface definition
 - VGRID/ VGRIDns—advancing front method to generate tetrahedral grids
 - USM3D/ USM3Dns—cell-centered finite-volume upwind flow solver
 - VPLOT3D—interactive, menu-driven extraction and display of flow data
- **Rapid Capability Advancements in the 1990s**
 - Frink: *Three-dimensional Upwind Scheme for Solving Euler Equations on Unstructured Tetrahedral Grids*, Ph.D. dissertation, Virginia Tech, 1991
 - Pirzadeh: *Structured Background Grids for Generation of Unstructured Grids by Advancing Front Method*, AIAA J, 31(2), 1993
 - Frink, Pirzadeh, and Parikh: *An Unstructured-grid Software System for Solving Complex Aerodynamic Problems*, NASA CP-3291, 1995
 - Frink and Pirzadeh: *Tetrahedral Finite-Volume Solutions to the Navier-Stokes Equations on Complex Configurations*, NASA/TM-1998-208961

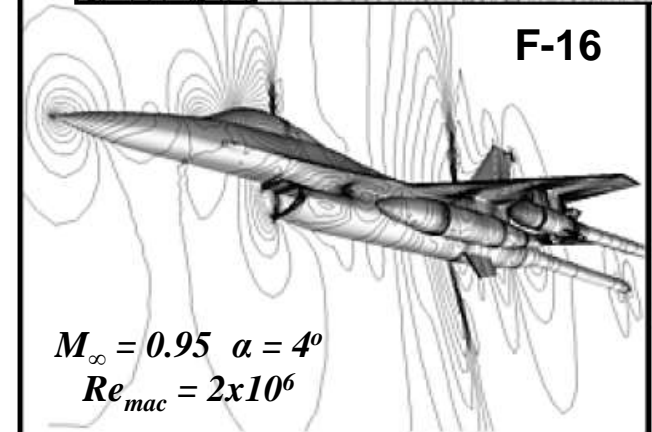
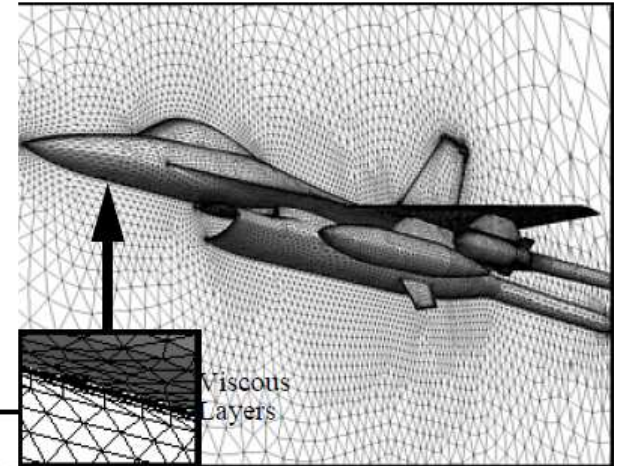

Decision Driven by Careful Cost-Benefit Assessment of the-then Prevalent Environment of Very Low In-house R&D Investments

Y2K: Mission Accomplished!

Goal of less than 24-hour turnaround time of full aircraft RANS simulation, set in early '90s, was achieved using TetrUSS (Thanks to the hard work and dedication of the ACA team in Georgia)

- **P-3C Airloads (Goble and Hooker)**

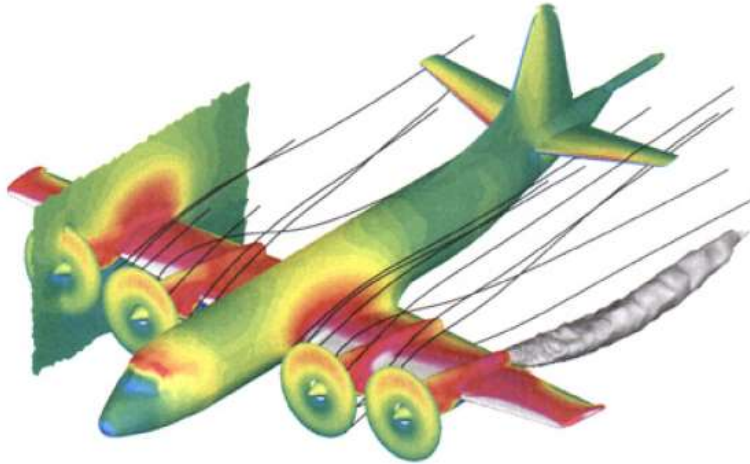

- Supported US Navy's Service Life Assessment Program (SLAP)
- Full aircraft grids with 7 million+ cells
- Nearly **300 aerodynamic loads cases** over entire flight envelope using **Cray T3E** and **SGI Origin 2000**
- Details in **AIAA 2001-1003**

- **KC-130J Refueling Pod (Hooker)**

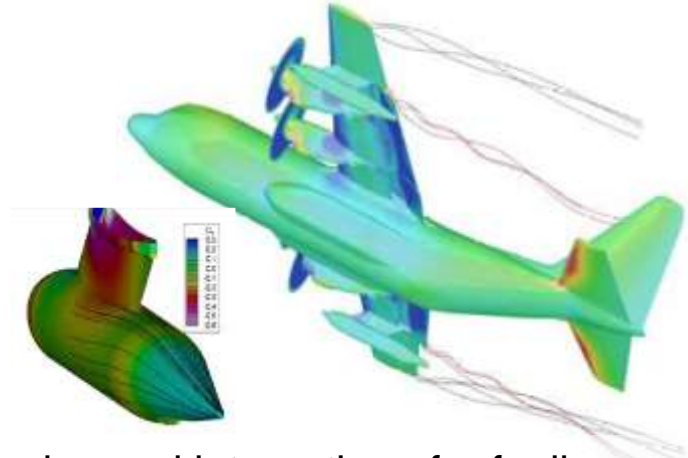

- Design and integration of refueling pods
- Full aircraft viscous grid with 7 million cells
- **Six full aircraft viscous solutions per day** with dedicated use of two **64-node PC clusters**; each node made up of **dual 850 MHz Intel Pentium III processors** with **768 MB RAM**
- Details in **AIAA 2002-2805**

RANS: Full Steam Ahead!

RANS-based ACA: Full Aircraft Analysis

Comparison of computed surface pressures with wind-tunnel test data for full-span 4% scale model of C-5 aircraft with flow-through HBPR TF-39 nacelles

$M_\infty = 0.75$ $\alpha = 2^\circ$ $Re_{mac} = 4.5 \times 10^6$

TetrUSS
~10 million cells
AIAA 2006-0856

Spalart-Allmaras turbulence model

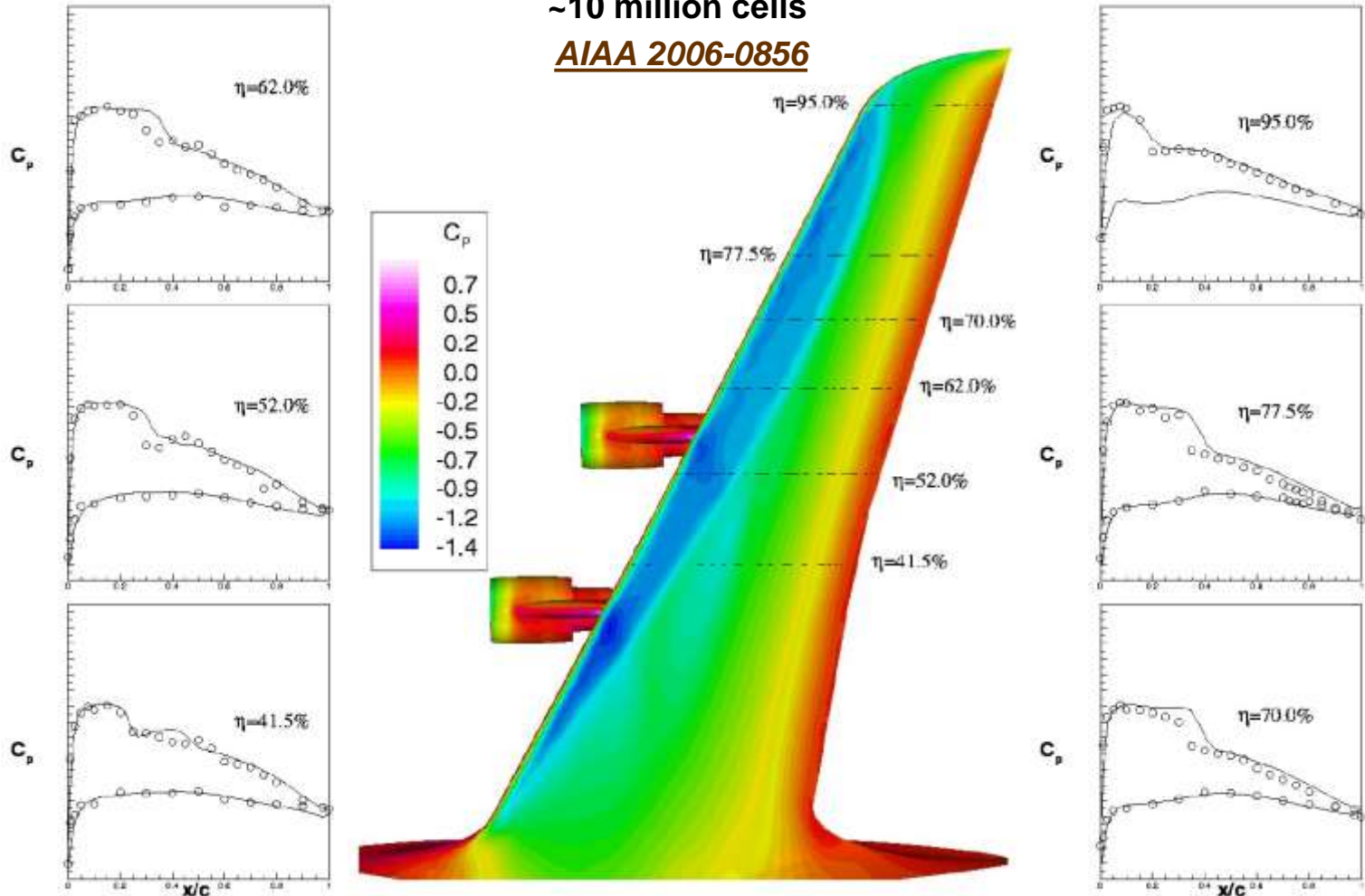

Good Agreement for Relatively Benign Flow Conditions

RANS-based ACA

Impressive Capabilities Demonstrated throughout the 2000s

F-22 Tail Buffet (2005)

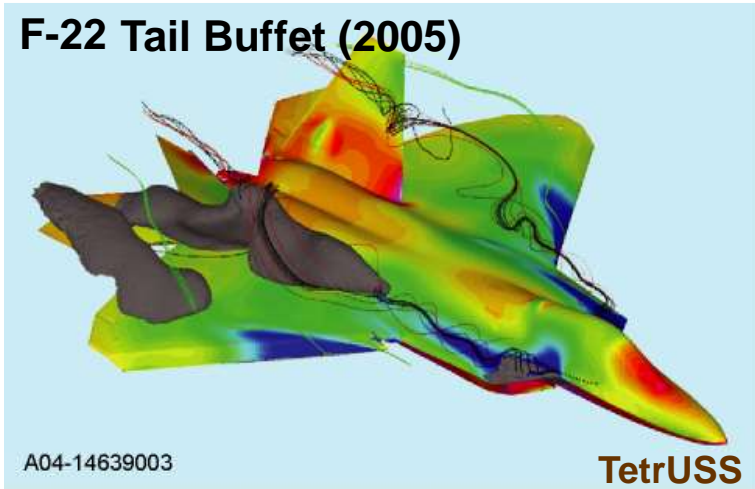

C-5M Re-engining (2006)

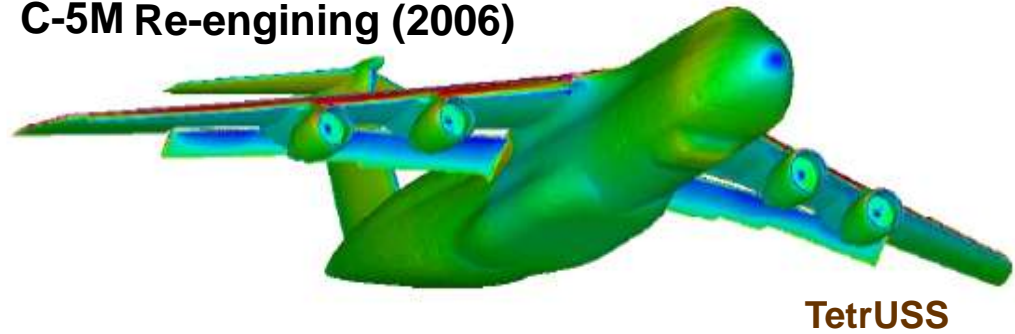

F-35 Performance (2007)

Bottom View

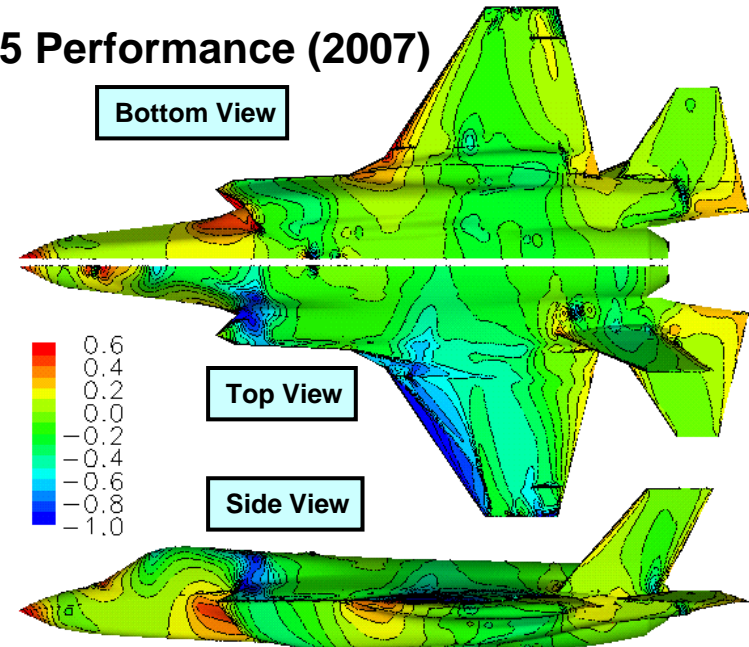

Falcon

**Low-boom
Supersonic
Airliner (2012)**

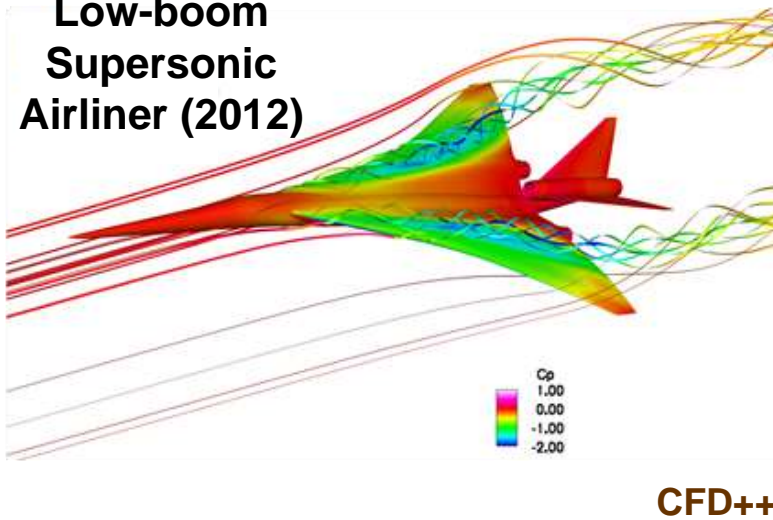

***Reasonably Quick and Affordable Flow Simulations for
a Wide Variety of Full Aircraft Configurations***

An Unexpected Turn in the Road As the 1990s Wind Down

- **July 1999: Author's Tech Fellow tenure ends! Management career begins!**

- Raj *appointed* Department Manager, Aerodynamics, Lockheed Martin Aeronautical Systems (LMAS), Marietta, Georgia, to manage technical staff, technology base, tools and processes to support all lines of business including F-22, C-130J, C-5M, etc.

“When you come to a fork in the road, take it.”
– Yogi Berra, American “Philosopher”



- **August 2000: Author's Skunk Works® tenure begins!**

- Lockheed Martin Aeronautics Company (LMAC) created in January 2000 by combining three legacy companies (LM Skunk Works, California; LM Aeronautical Systems, Georgia; LM Tactical Aircraft Systems, Texas) in Aeronautics Sector into one with 3 sites (California, Georgia, Texas) to improve chances of winning Joint Strike Fighter!
- Raj selected to serve as Senior Manager, Vehicle Science & Systems, Technology Development & Integration, Advanced Development Programs (the Skunk Works®), LMAC--Palmdale, California, site
- Primary Responsibility: lead high caliber teams to meet technology needs in *Aerodynamics & CFD, Acoustics, Airframe Propulsion Integration, Flight Control, Mass Properties, Vehicle Management System, Utility Systems Integration, and Electrical Power Distribution* for all LMAC product lines at the three sites

“The Only Constant in Life Is Change.”
– Heraclitus of Ephesus
Ancient Greek pre-Socratic philosopher

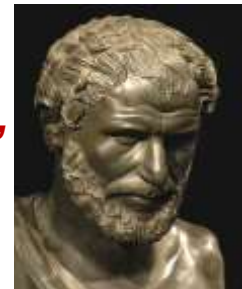

- **CFD in the 1980s**
 - **Golden era of Euler methods!**
 - **Rapid progress characterized by advances in**
 - **Pre-processing**—*extract “watertight” surface geometry from CAD or other sources*
 - **Grid generation**—*discretize computational domain*
 - ✓ many new methods evolved structured hexahedral and unstructured tetrahedral grids
 - **Euler solver**—*solve the unsteady form of Euler equations using a code with following algorithmic features*
 - ✓ Finite volume or finite element formulations
 - ✓ Node centered or cell-centered schemes
 - ✓ Central difference with explicitly added numerical dissipation or Upwind difference with implicit dissipation
 - ✓ Pseudo-time marching and multigrid for accelerated convergence to steady state
 - **Post-processing**—*plot forces, moments, surface pressures and flow field data*
 - **Lockheed Focus: Full Aircraft Euler Analysis to Meet Advanced Tactical Fighter Needs (*flows with strong shocks and with free-vortices or leading-edge vortices*)**
 - Development of **TEAM** code (**T**hree-dimensional **E**uler/**N**avier-**S**tokes **A**erodynamic **M**ethod) under a USAF, WRDC (Wright Research & Development Center) contract (1984-1989)
 - Strategy for **Effectiveness**
 - ✓ Modular Computational System—*ease of incorporating technology advances*
 - ✓ Patched Zonal Hexahedral Grids—*analysis of complete aircraft*
 - ✓ Solver based on Jameson’s FLO-57 code—*robust and economical method*
 - finite-volume formulation, cell-centered scheme
 - central differences with Jameson-Schmidt-Turkel (JST) adaptive dissipation
 - Multistage pseudo time stepping to steady state

Section 5.2: Key Takeaways (2 of 3)

- Team validation using many configurations and a range of flow conditions
- 1988: TEAM (Euler) analysis of full YF-22 Dem/Val configuration
- 1988-1989: Assessment of TEAM (Euler) Effectiveness based on YF-22 Dem/Val Application
 - Grid Generation: Tedious and time consuming
 - Extensive Validation: Limited value (*Lesson Learned: must be done for geometries and flow conditions that aren't substantially different from the intended application*)
 - Total Drag: Unable to predict using inviscid Euler code
 - Surface Pressures: Deemed useful for structural design...but increments for deflected control surfaces would be really useful
- Many promising technologies to increase Effectiveness, but none mature enough to meet the anticipated needs of F-22 EMD effort in 1991 time frame
- Interim Path Forward
 - Make maximum use of the multi-zone grid for the baseline configuration—once it is built
- 1990: Innovative Approach to estimation of incremental loads due to control surface deflections for multiple settings
 - Surface transpiration concept incorporated in TEAM to simulate control surface deflections

Section 5.2: Key Takeaways (3 of 3)

- **The Exciting Eighties**
 - Launch of the 1st Space Shuttle (*April 12, 1981*)
 - USAF Advanced Tactical Fighter (ATF): *RFI (Jun 1981); RFP (Sep 1985); 50-month Dem/Val contract award to Lockheed and Northrop (Oct 1986)*
 - Boeing: *767 first flight (Sept 26, 1981); 757 first flight (Feb 26, 1982)*
 - Grumman X-29 First Flight (*Dec 14, 1984*)
 - Airbus First Flight (*Feb 22, 1987*)
- **The Nasty Nineties**
 - “Peace Dividend” contributed to US aerospace industry depression resulting in mergers and consolidations: 15 down to 4 in 7 years!
- **Feb 1991: Realization [by author] that higher level CFD (Euler/Navier-Stokes) had little to no impact on reducing the number of YF-22 design cycles—*more design cycles in a given time is key to affordable quality!***
 - An area of author’s focus ever since assuming Tech Fellow position in Jan 1992
- **April 1991: Lockheed awarded F-22 EMD contract**
- **Fall 1991: F-22 EMD Team (Euler) Application**
 - Full-aircraft forces, moments and airloads predictions for a wide range of flow conditions--with and without control surface deflections
 - 370 cases run over three months, using 1600 CPU hours on Cray-Y/MP 2/16
 - ***But...NO TOTAL DRAG! ACA wasn't ready. F-22 Program relied on wind-tunnel testing***
- **Throughout 1990s: Focus on increasing TEAM effectiveness**
 - Extend TEAM to solving RANS equations for full configurations
 - Explore and implement means of automating grid generation and affordable HPC
- **Y2K: 24-hour turnaround time of full-aircraft RANS analysis using TetrUSS!**
- ***“The only constant in life is change”***

BIBLIOGRAPHY

SECTION 5

5. Evolution of Applied Computational Aerodynamics (1950-2000)

5.2 Pursuit of Effectiveness (1980–2000)

- 5.2.1 Miranda, L. R., "Application of computational aerodynamics to airplane design", AIAA Journal of Aircraft, Vol. 21, No. 6 (1984), pp. 355-370. (Also AIAA Paper 82-0018, 20th Aerospace Sciences Meeting, Orlando, Florida, January 11-14, 1982) <https://doi.org/10.2514/3.44974>
- 5.2.2 Rizzi, A. and Eriksson, L.E., "Transfinite Mesh Generation and Damped Euler Equation Algorithm for Transonic Flow Around Wing-Body Configurations," AIAA Paper 81-0999, June 1981.
- 5.2.3 Jameson, A., Schmidt, W. and Turkel, E., "Numerical Solution of the Euler Equations by Finite-Volume Methods Using Runge-Kutta Time-Stepping Schemes," AIAA Paper 81-1259, June 1981.
- 5.2.4 Usab, Jr., W.J. and Murman, E.M., "Embedded Mesh Solutions of the Euler Equations Using a Multi-grid Method," AIAA 83-1946-CP, 6th Computational Fluid Dynamics Conference, Danvers, MA, 13-15 July 1983 <https://doi.org/10.2514/6.1983-1946>
- 5.2.5 Jameson, A. and Baker, T.J., "Multigrid Solution of the Euler Equations for Aircraft Configurations," AIAA-84-0093, 22nd Aerospace Sciences Meeting, Reno, Nevada, January 1984.
- 5.2.6 Benek, J.A., Buning, P.G., and Steger, J.L., "A 3-D Chimera Grid Embedding Technique," AIAA Paper 85-1523-CP, 7th Computational Physics Conference, Cincinnati, Ohio, 15-17 July 1985.
- 5.2.7 Löhner, R., Morgan, K., Peraire, J., and Zienkiewicz, O.C., "Finite Element Methods for High Speed Flows," AIAA-85-1531-CP, 7th Computational Physics Conference, Cincinnati, Ohio, 15-17 July 1985.
- 5.2.8 Jameson, A., Baker, T.J., and Weatherill, N.P., "Calculation of Inviscid Transonic Flow over a Complete Aircraft," AIAA Paper 86-0103, 24th Aerospace Sciences Meeting, Reno, Nevada, January 6-9, 1986.
- 5.2.9 Mavripllis, D.J., "Accurate multigrid solution of the Euler equations on unstructured and adaptive meshes," NASA CR 181679, June 1988.
- 5.2.10 Raj, P., "A Generalized Wing-Body Euler Code, FLO-57GWB," Lockheed-California Company Report, LR 30490, June 1983.
- 5.2.11 Sikora, J. S., and Miranda, L. R., "Boundary Integral Grid Generation Technique," AIAA Paper 85-4088, 3rd Applied Aerodynamics Conference, Colorado Springs, Colorado, October 14-16, 1985.
- 5.2.12 Singer, S.W., and Mattson, E.A., "Internal and External Flow Simulation Using Multizone Euler/Navier-Stokes Aerodynamic Method," SAE Paper 901856, October 1990.
- 5.2.13 Raj, P, Olling, C.R., Sikora, J.S., Keen, J.M., Singer, S.W., and Brennan, J.E., "Three-dimensional Euler/Navier-Stokes Aerodynamic Method (TEAM), Volume I: Computational Method and Verification," AFWAL-TR-87-3074, June 1989 (*supersedes December 1987 release*).

BIBLIOGRAPHY

SECTION 5.2 (contd.)

- 5.2.14 Raj, P, Olling, C.R., Sikora, J.S., Keen, J.M., Singer, S.W., and Brennan, J.E., “Three-dimensional Euler/Navier-Stokes Aerodynamic Method (TEAM), Volume II: Grid Generation User’s Manual,” AFWAL-TR-87-3074, June 1989 (*supersedes December 1987 release*).
- 5.2.15 Raj, P, Olling, C.R., Sikora, J.S., Keen, J.M., Singer, S.W., and Brennan, J.E., “Three-dimensional Euler/Navier-Stokes Aerodynamic Method (TEAM), Volume III: Flow Analysis User’s Manual,” AFWAL-TR-87-3074, June 1989 (*supersedes December 1987 release*).
- 5.2.16 Raj, P., “Aerodynamic Analysis Using Euler Equations: Capabilities and Limitations,” Chapter 18, Applied Computational Aerodynamics, Progress in Astronautics and Aeronautics, Vol. 125, AIAA, Washington D.C., 1990, Henne, P.A. (Editor).
- 5.2.17 Singer, S.W., and Mattson, E.A., “Internal and External Flow Simulation Using Multizone Euler/Navier-Stokes Aerodynamic Methods,” SAE Paper 901856, Aerospace Technology Conference and Exposition, Long Beach, CA, October 1-4, 1990.
- 5.2.18 Eriksson, L.E., and Rizzi, A., “Computation of Vortex Flows Around Wings Using the Euler Equations,” Proceedings of the 4th GAMM Conference on Numerical Methods in Fluid Mechanics, October 1981.
- 5.2.19 Hitzel, S.M. and Schmidt, W., “Slender Wings with Leading Edge Vortex Separation: A Challenge for Panel Methods and Euler Solvers,” AIAA Journal of Aircraft, Vol. 21, No. 10, 1984, pp 751-759.
- 5.2.20 Raj, P., and Sikora, J.S., “Free-Vortex Flows: Recent Encounters with an Euler Code,” AIAA Paper 84-0135, 22nd Aerospace Sciences Meeting, Reno, NV, January 9-12, 1984.
- 5.2.21 Murman, E.M., and Rizzi, A., “Applications of Euler Equations to Sharp Edge Delta Wings with Leading Edge Vortices,” AGARD Symposium on Application of Computational Fluid Dynamics in Aeronautics, Aux-Ed-Provence, France, April 1986.
- 5.2.22 Raj, P., Sikora, J.S. and Keen, J.M., “Free-Vortex Flow Simulation Using a Three-dimensional Euler Aerodynamic Method,” ICAS Paper 86-1.5.2, Proceedings of the 15th Congress of the International Council of the Aeronautical Sciences, London, England, U.K., September 7-12, 1986.
- 5.2.23 Raj, P., Keen, J.M., and Singer, S.W., “Applications of an Euler Aerodynamic Method to Free-Vortex Flow Simulation,” AIAA paper 88-2517, Proceedings of the 6th Applied Aerodynamics Conference, Williamsburg, VA, June 6-8, 1988. (Also in AIAA Journal of Aircraft, Vol. 27, No. 11, November 1990, pp 941-949).
- 5.2.24 Raj, P., “An Euler Code for Nonlinear Aerodynamic Analysis: Assessment of Capabilities,” SAE Transactions, Vol. 97, Section 1: JOURNAL OF AEROSPACE (1988), pp. 1305-1320. (Also SAE Paper 881486, October 1988)
- 5.2.25 Raj, P., “Recent Developments in the Computational Solutions of Euler Equations (Invited),” Third International Congress of Fluid Mechanics, Cairo, Egypt, January 1990.
- 5.2.26 Raj, P., and Singer, S.W., “Computational Aerodynamics in Aircraft Design: Challenges and Opportunities for Euler/Navier-Stokes Methods,” SAE Transactions, Vol. 100, Section 1: JOURNAL OF AEROSPACE, Part 2 (1991), pp 2069-2081 (Also iPAC 911990, International Pacific Air & Space Technology Conference, Gifu, Japan, October 7-11, 1991).

BIBLIOGRAPHY

SECTION 5.2 (contd.)

- 5.2.27 Steinbrenner, J.P., Chawner, J.R., and Fouts, C.L., "A Structured Approach to Interactive Multiple Block Grid Generation," Application of Mesh Generation to Complex 3-D Configurations, AGARD-CP-464, March 1990.
- 5.2.28 Steinbrenner, J.P., Chawner, J.R., and Fouts, C.L., "Multiple Block Grid Generation in the Interactive Environment," AIAA 90-1602, AIAA 21st Fluid Dynamics, Plasma Dynamics and Lasers Conference, Seattle, WA, June 18-20, 1990.
- 5.2.29 Steinbrenner, J.P., Chawner, J.R., and Fouts, C.L., "The GRIDGEN 3D Multiple Block Grid Generation System," WRDC-TR-90-3022, July 1990.
- 5.2.30 Steinbrenner, J.P., and Anderson, D.A., "Grid Generation Methodology in Applied Aerodynamics," Chapter 4, Applied Computational Aerodynamics, Progress in Astronautics and Aeronautics, Vol. 125, AIAA, Washington D.C., 1990, Henne, P.A. (Editor).
- 5.2.31 Clarke, D.K., Salas, M.D., and Hassan, H.A., "Euler Calculations for Multielement Airfoils using Cartesian Grids," AIAA Journal, Vol. 24, No. 3, March 1986, pp. 353-358.
- 5.2.32 Raj, P., and Harris, B., "Using Surface Transpiration with an Euler Method for Cost-effective Aerodynamic Analysis," AIAA 93-3506, Proceedings of the 11th AIAA Applied Aerodynamics Conference, Monterey, CA, August 9-11, 1993.
- 5.2.33 Bangert, L.H., Johnston, C.E., and Schoop, M.J., "CFD Applications in F-22 Design," AIAA Paper 93-3055, July 1993.
- 5.2.34 Goble, B.D., King, S., Terry, J., and Schoop, M.J., "Inlet Hammershock Analysis Using a 3-D Unsteady Euler/Navier-Stokes Code," AIAA 96-2547, 32nd AIAA, ASME, SAE and ASEE, Joint Propulsion Conference and Exhibit, Lake Buena Vista, FL, July 1-3 1996
- 5.2.35 Kinard, T.A., and Harris, B.W., "Evaluation of Two Unstructured CFD Methods," AIAA Paper 94-1877, 12th Applied Aerodynamics Conference, Colorado Springs, Colorado, June 20-24, 1994.
- 5.2.36 Kinard, T.A., Finley, D.B., and Karman, Jr., S.L., "Prediction of Compressibility Effects Using Unstructured Euler Analysis on Vortex Dominated Flow Fields," AIAA 96-2499, 14th Applied Aerodynamics Conference, New Orleans, Louisiana, June 17-20, 1996.
- 5.2.37 Raj, P., Kinard, T.A., and Vermeersch, S.A., "Vortical Flow Simulation Using an Unstructured-Grid Euler Method," ICAS 96-1.4.5, Proceedings of the 20th Congress of the International Council of the Aeronautical Sciences, Sorrento, Italy, September 1996.
- 5.2.38 Olling, C.R., and Mani, K.K., "Navier-Stokes and Euler Computations of the Flow Field Around a Complete Aircraft," SAE paper 881488, October 1988.
- 5.2.39 Raj, P., Olling, C.R., and Singer, S.W., "Application of Euler/Navier-Stokes Aerodynamic Methods to Aircraft Configuration," ICAS Paper 90-6.4.4, Proceedings of the 17th Congress of the International Council of the Aeronautical Sciences, Stockholm, Sweden, September 9-14, 1990.
- 5.2.40 Goble, B.D., Raj, P., and Kinard, T.A., "Three-dimensional Euler/Navier-Stokes Aerodynamic Method (TEAM) Upgrade, Version 713 User's Manual," WL-TR-93-3115, February 1994.

BIBLIOGRAPHY

SECTION 5.2 (contd.)

- 5.2.41 Kinard, T.A., Harris, B.W., and Raj, P., “An Assessment of Viscous Effects in Computational Simulation of Benign and Burst Vortex Flows on Generic Fighter Wind-Tunnel Models Using TEAM Code,” NASA Contractor Report 4650, March 1995.
- 5.2.42 Kinard, T.A., Harris, B., and Raj, P., “Computational Simulation of Benign and Burst Vortex Flows,” AIAA Paper 95-1815, Proceedings of the 13th Applied Aerodynamics Conference, San Diego, CA, June 19-22, 1995.
- 5.2.43 Frink, N.T., Pirzadeh, S., and Parikh, P., “An Unstructured-Grid Software System for Solving Complex Aerodynamic Problems,” NASA CP 3291, pp 289-308. (Also NASA Workshop on Surface Modeling, Grid Generation and Related Issues in Computational Fluid Dynamics (CFD) Solutions, NASA-Lewis Research Center, Cleveland, OH, May 9-11, 1995)
- 5.2.44 Frink, N.T., and Pirzadeh, S.Z., “Tetrahedral Finite-Volume Solutions to the Navier-Stokes Equations on Complex Configurations,” NASA/TM-1998-208961, December 1998.
<https://ntrs.nasa.gov/archive/nasa/casi.ntrs.nasa.gov/19990007832.pdf>
- 5.2.45 Goble, B.D., and Hooker, J.R., “Validation of an Unstructured Grid Euler/ Navier-Stokes Code on a Full Aircraft with Propellers,” AIAA Paper 2001-1003, 39th Aerospace Sciences Meeting, Reno, Nevada, 8-11 January 2001.
- 5.2.46 Hooker, J.R., “Aerodynamic Development of a Refueling Pod for Tanker Aircraft,” AIAA Paper 2002-2805, 20th Applied Aerodynamic Conference, St. Louis, Missouri, 24-26 June 2002.
- 5.2.47 Cunningham, A.M., Jr., Anderson, W.D., Patel, S.R., and Black, C.L., “Lockheed Martin Aeronautics Perspective on Aircraft Buffet Prediction and Analysis,” Symposium on Flow-Induced Unsteady Loads and Impact on Military Applications, Applied Vehicle Technology Panel (AVT), NATO, Budapest, Hungary, 25-28 April 2005.
- 5.2.48 Hooker, J.R., Hoyle, D.L., and Be6.1s, D.N., “The Application of CFD for the Aerodynamic Development of the C-5M Galaxy,” AIAA 2006-0856, 44th Aerospace Sciences Meeting, Reno, Nevada, 9-12 January 2006.
- 5.2.49 Wooden, P.A., Smith, B.R. and Azevedo, J.J., “CFD Predictions of Wing Pressure Distributions on the F-35 at Angles-of-Attack for Transonic Maneuvers,” AIAA-2007-4433, 25th Applied Aerodynamics Conference, Miami, Florida, 25-28 June 2007.
- 5.2.50 Morgenstern, J., Buonanno, M., and Norstrud, N., “N+2 Low Boom Wind Tunnel Model Design and Validation,” AIAA 2012-3217, 30th Applied Aerodynamics Conference, New Orleans, LA, 27 June 2012.

	Slide #
Preface	3
1. Introduction and Scope	11
2. Genesis of Fluid Dynamics (<i>Antiquity to 1750</i>)	52
3. Fluid Dynamics as a Mathematical Science (<i>1750–1900</i>)	77
4. Emergence of Computational Fluid Dynamics (<i>1900–1950</i>)	98
5. Evolution of Applied Computational Aerodynamics (<i>1950–2000</i>)	124
5.1 <i>Infancy through Adolescence (1950–1980)</i>	127
Level I: Linear Potential Methods (LPMs)	127
Level II: Nonlinear Potential Methods (NPMs)	138
5.2 <i>Pursuit of Effectiveness (1980–2000)</i>	163
Level III: Euler Methods	167
Level IV: Reynolds-Averaged Navier-Stokes (RANS) Methods	210
6. ACA Effectiveness: Status and Prospects (<i>2000 and Beyond</i>)	229
6.1 <i>Assessment of Effectiveness (2000–2020)</i>	231
6.2 <i>Prospects for Fully Effective ACA (Beyond 2020)</i>	261
7. Closing Remarks	286
Appendix A	295

ACA Evolution Has Paralleled *Gartner Hype Cycle of CFD Technology!*

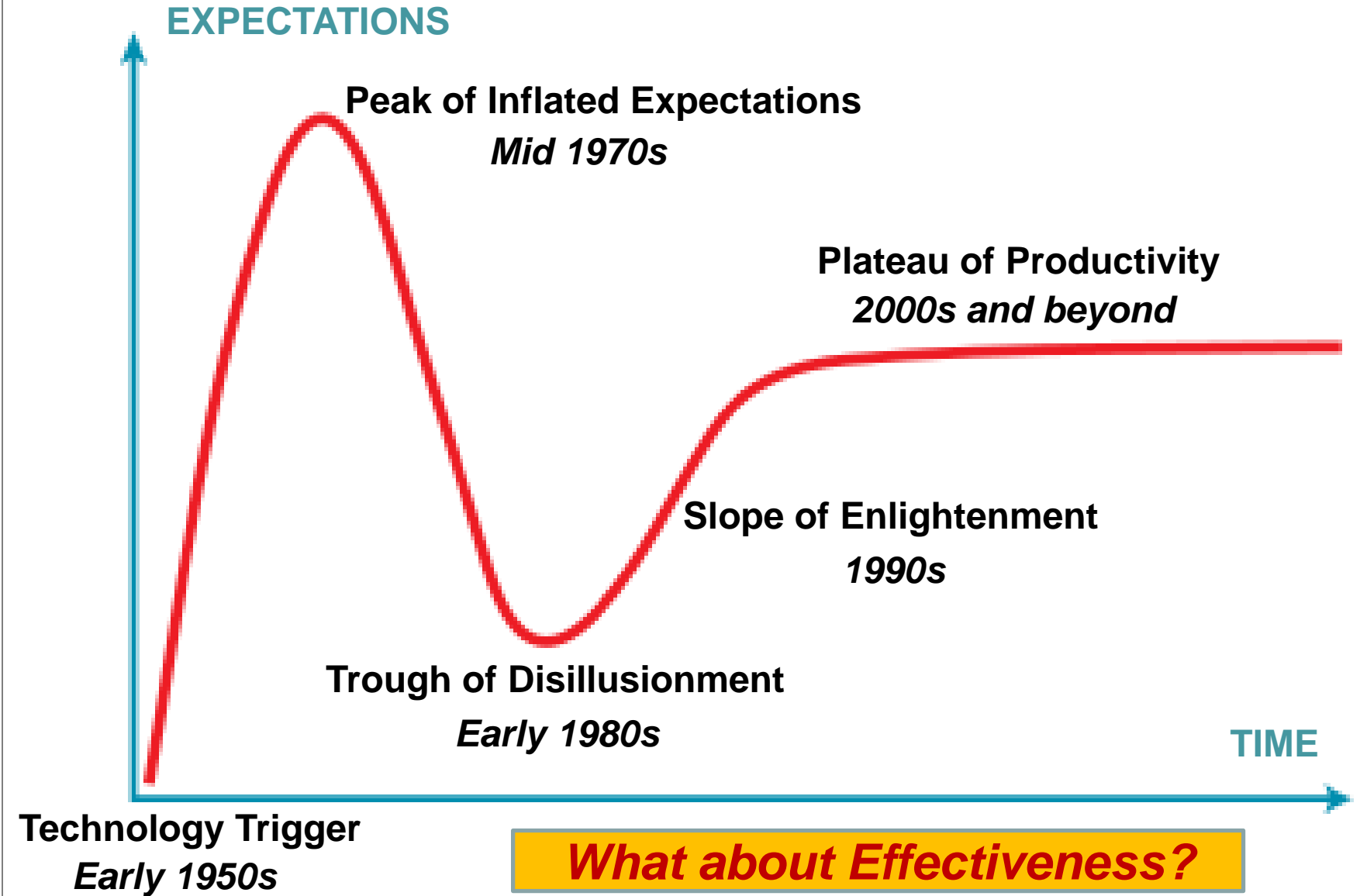

Status of ACA Effectiveness

In this section, we more closely examine

- (a) the status of the effectiveness of RANS-based ACA since the 2000s when RANS CFD methods were finding widespread use as their productivity had reached an acceptable level, and*
- (b) barriers to achieving fully effective ACA.*

Maximizing Effectiveness Has Been the “North Star” of Author’s ACA Efforts Since the Inception of “Miranda’s Law” in 1980

Degree of ACA Effectiveness Depends on the Ability to Provide Credible Solutions (that Replicate Reality) While Meeting Cost & Schedule Constraints

- **Qualitative Approach**

- This is the approach proposed by Miranda
- Assessment is based on engineer's judgment about 'quality' and 'acceptance' factors

- **Quantitative Approach**

- A simple *quasi*-quantitative approach is devised and proposed by the author
- It uses an "effectiveness index" as a composite of a "quality index" and an "acceptance index" (See Appendix A)

Design Teams, in Collaboration with ACA Practitioners, Are Best Suited to Assess ACA Effectiveness, Not the Developers

Author's Assessment of the Effectiveness of RANS-based ACA (ca early 2000s)

Although RANS simulations of full aircraft configurations are [acceptably?] quick and affordable, predictions of aerodynamic characteristics aren't always credible* *especially for complex flows dominated by separation and free vortices!*

*credible: how faithfully do the predictions imitate reality

Dilemma when designing novel configurations in a simulation based design environment

- If RANS simulations predict flow separation or free vortices, are the data credible enough to invest additional time and effort for configuration redesign?
- If expensive and time-consuming wind-tunnel tests must be done for validating RANS predictions—doesn't it defeat the purpose of using RANS in the first place?

ACA Effectiveness: Less Than Satisfactory!

Boeing Assessment of RANS CFD for Aircraft Design Applications (2005)

Tinoco, E., Bogue, D., Kao, T., Yu, N., Li, P., and Ball, D., "Progress toward CFD for full flight envelope," *The Aeronautical Journal*, Royal Aeronautical Society, Volume 109, Issue 1100, October 2005, pp 451-460.

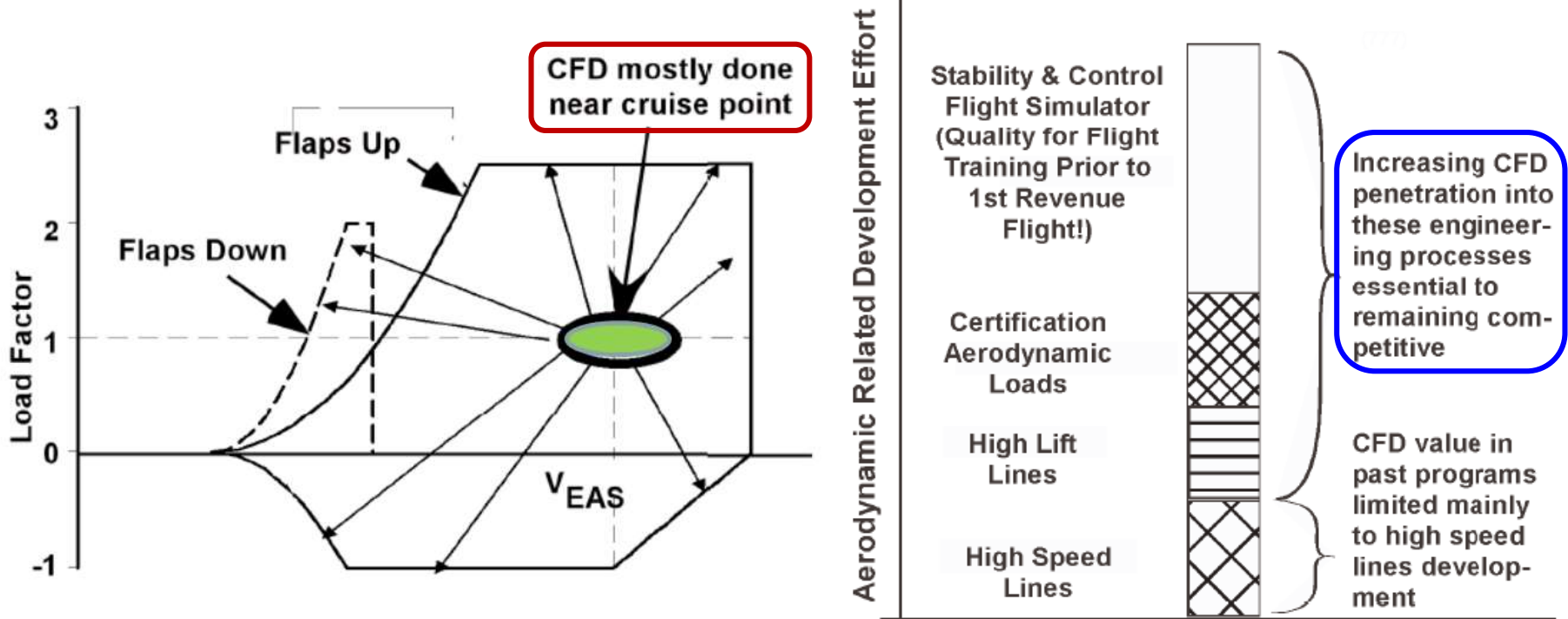

“The major impact of CFD, delivered to date at Boeing, has mainly been related to its application to *high speed cruise*.”

Severely Limited Scope of Applications

TetrUSS simulations by Frink et al, *AIAA Journal of Aircraft*, 2012

NATO RTO AVT-161: Stability And Control CONfiguration (SACCON)

$M = 0.149$; $\alpha = 0^\circ$ to 30° ; $Re = 1.6 \times 10^6$

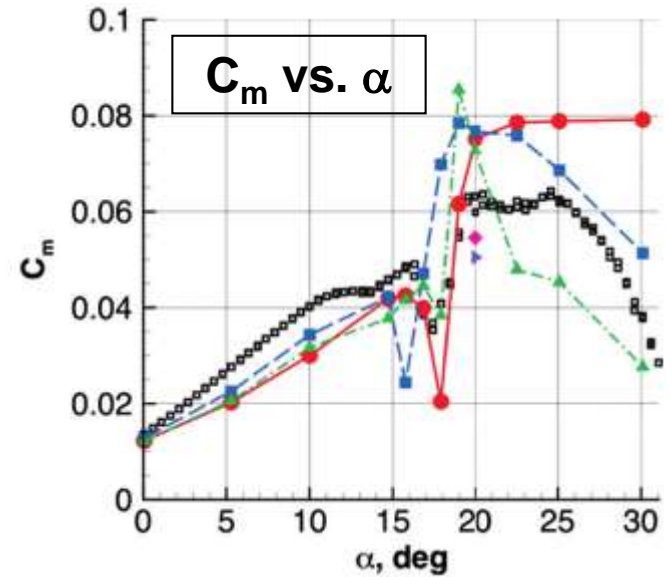
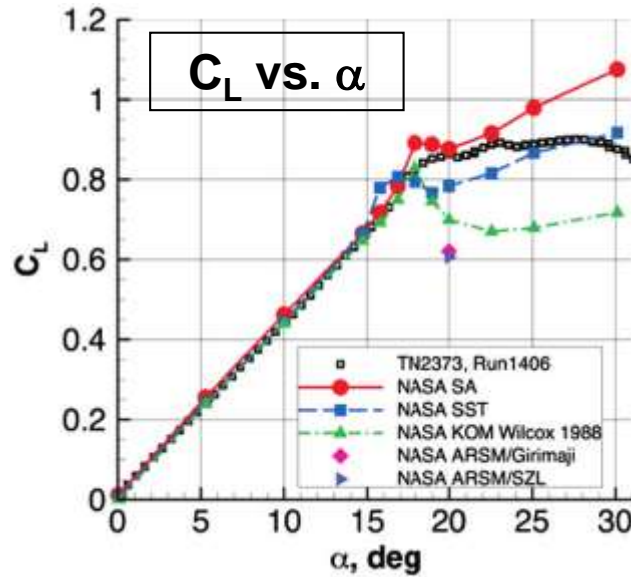
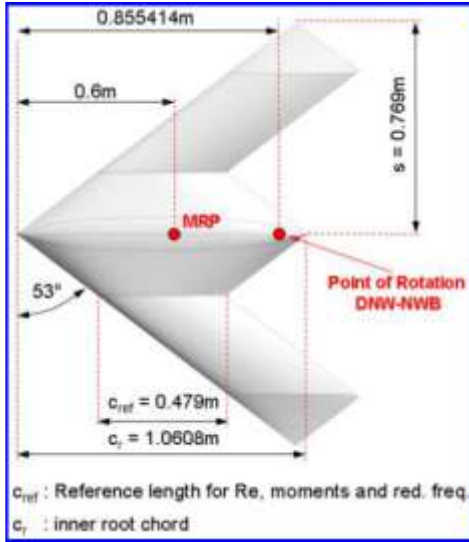

Wide variation in data among state-of-the-art turbulence models!

Laminar-to-turbulent transition modeling: yet another challenge!

Predictions are NOT Credible for Flows with Separation and/or Free Vortices

RANS-based ACA: *The Overarching Challenge*

PRODUCING CREDIBLE SOLUTIONS

***Assessing and Overcoming this Challenge
Has Been a Constant Focus of
the ACA Community Ever Since the Early 2000s***

Assessment of RANS Predictions: *Absolute (Total) Drag*

AIAA CFD Drag Prediction Workshops (DPWs)

- **Formally initiated in 2000**; seven (7) workshops to date: 2001, 2003, 2006, 2009, 2012, 2016, and 2022; numerous publications
- **Primary Goal:** *Assess state-of-the-art CFD methods as practical aerodynamic tools for the prediction of forces and moments on industry-relevant geometries, with a focus on absolute drag.*
- **Test Cases:** *Variants of commercial transport wing-body configurations; transonic flows; many meshes and flow-solvers; multiple turbulence models*



Importance of Accurate Prediction Cannot Be Over Emphasized!

Importance of Accurate Drag Estimation

C-141 Cruise Drag (early 1960s)

- Total Drag predicted based on wind-tunnel tests was within **One Count (0.0001) of flight data...**
...but good agreement was due to Compensating Errors!
 - Minimum Profile Drag: *underpredicted*
 - Compressibility Drag: *overpredicted*
- DoD Aeronautical Test Facilities Assessment Team (1997)
 - **Question: Can we do better with improved wind-tunnel test techniques combined with CFD?**
 - **Answer: Cruise drag would be underpredicted by 3.5%**
 - *Considering only Reynolds Number Scaling*
 - *Minimum Profile Drag Underprediction—about eight (8) counts*
 - *Compressibility Drag Overprediction—eliminated*



Erroneous Predictions would Increase Fuel Cost by \$688M (FY96 dollars) for Entire Fleet over Service Life

Importance of Accurate Drag Estimation

C-5 Cruise Drag (mid 1960s)

- **Total drag overpredicted by 2.5% based on wind-tunnel tests**

- Minimum Profile Drag: *underpredicted by one scale-up method and correctly predicted by another*
- Compressibility Drag: *overpredicted*



- **DoD Aeronautical Test Facilities Assessment Team (1997)**

- **Question: Can we do better with improved wind-tunnel test techniques combined with CFD?**
- **Answer: Cruise drag would be underpredicted by 1.5%**
 - *Considering only Reynolds Number Scaling*
 - Minimum Profile Drag Underprediction—*1% to 3%*
 - Compressibility Drag Overprediction—*eliminated*

Erroneous Predictions would Increase Fuel Cost by \$153M (FY96 dollars) for Entire Fleet over Service Life!

Importance of Accurate Drag Estimation

F-22 Cruise Drag Example (1990s)

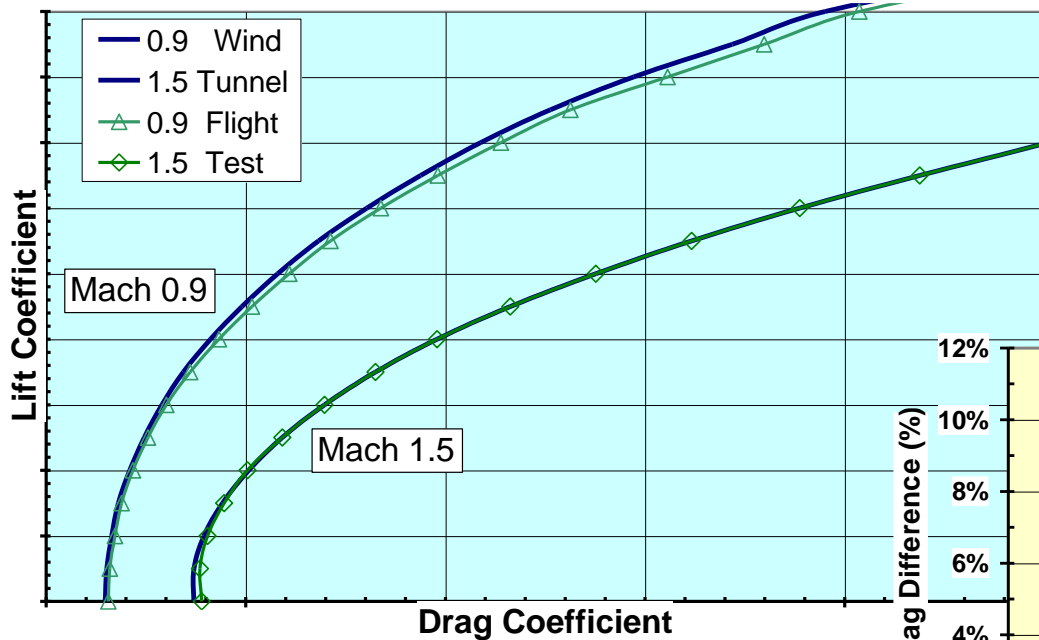

Percent Drag Difference between Preliminary Flight Test Results and Wind Tunnel Predictions at 1G

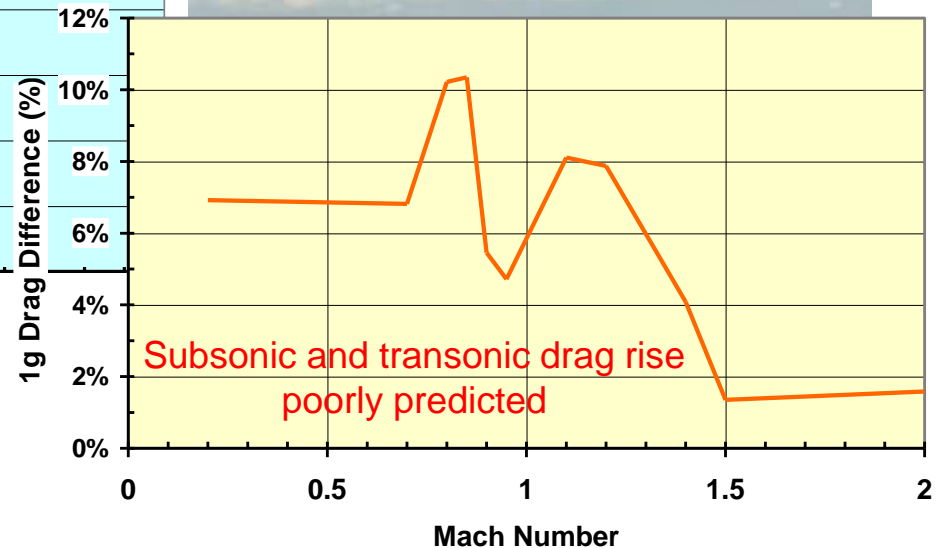

- Drag predicted using wind-tunnel tests matched well with flight test data for Mach 0.9 and 1.5

- Differences may be due to a combination of interpolated pieces
 - Thrust effects, auxiliary inlet and vents, control surface scheduling

Poor Drag Predictions Impacted Accelerations, Decelerations, Cruise and Loiter Performance

Importance of Accurate Drag Estimation

HSCT Conceptual Design MDO Study (mid 1990s)

- High Speed Civil Transport
 - Cruise Mach Number: 2.4
 - Range: 5,500 nm
 - Payload: 250 passengers

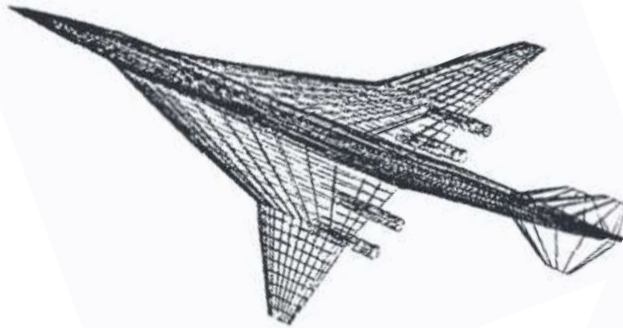

- TOGW = 772,907 lbs.
- Fuel Weight Fraction = 0.52
- Empty Weight Fraction = 0.39
- Aspect Ratio = 2
- $(L/D)_{\max} = 9.16$

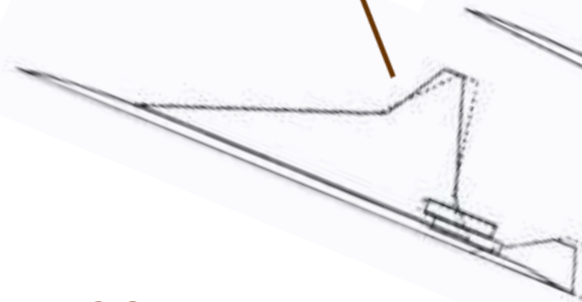
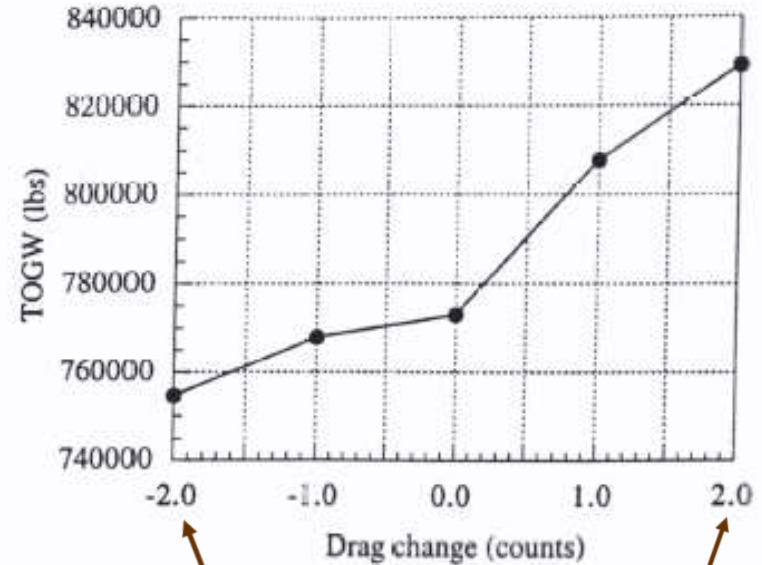

TOGW = 754,560 lbs.

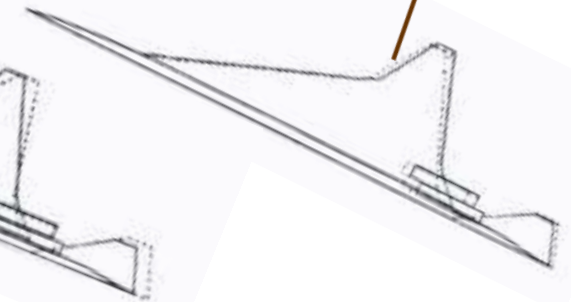

TOGW = 829,100 lbs.

Just Two-count Cruise Drag Overestimation Increases Take-Off Gross Weight by More Than 7%!

Some Interesting Findings: Tinoco et al, *Journal of Aircraft*, 55 (4), 2018

- **NASA Common Research Model (CRM) Wing-Body (WB)**

- $M = 0.85$; $Re = 40$ million; $C_L = 0.5$
- 54 datasets; multiple turbulence models
- *Solutions exhibited “tighter” convergence of total drag with a spread of less than 10 counts [1 count = 0.0001]*



- **NASA CRM WB Static Aeroelastic Effect**

- *Higher lift predicted at a given angle of attack, and more negative (nose down) pitching moment at a given lift coefficient than observed in test data.*

- **NASA CRM Wing-Body-Nacelle-Pylon**

- *Drag increment predicted within the uncertainty of the test data... this is of significant importance to industry design processes*



“One must ask if steady RANS is adequate for modeling this flow regime [with shocks and uffet]. Will URANS be adequate, or must one go to an eddy resolving method such as detached Eddy simulation to accurately simulate this flow regime?”

AIAA 7th CFD DPW (2022): Case 2a

- Wing-Body static aeroelastic/buffet study
 - Investigate CFD predictions where significant flow separation is expected [around $\alpha = 4^\circ$]
 - $M = 0.85$; $Re = 20$ million; α sweep, 2.50° to 4.25° in 0.25° increments
 - 29 datasets; six turbulence models

NASA Common Research Model (CRM)

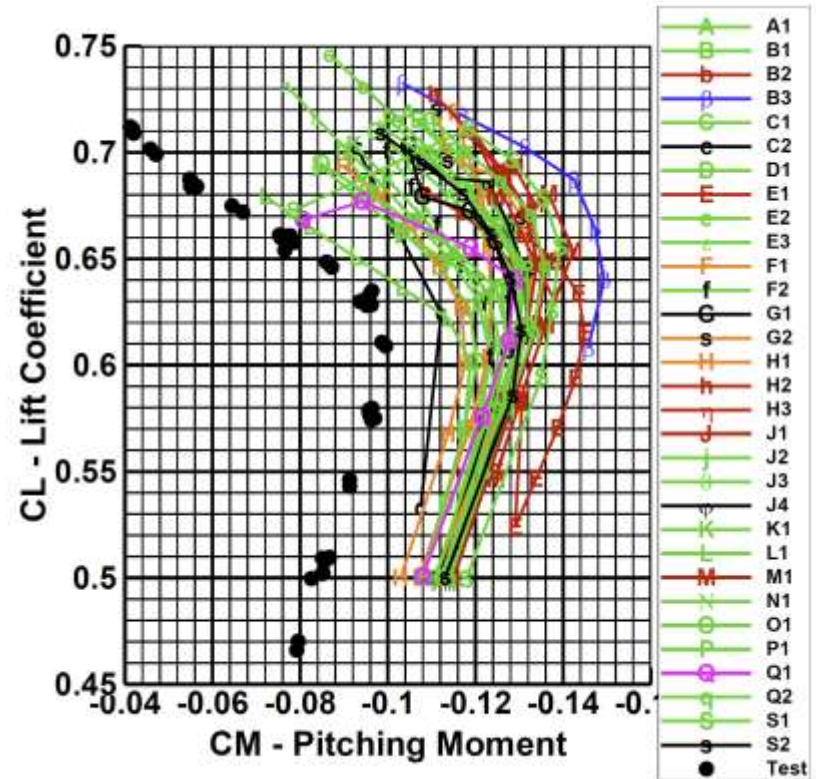
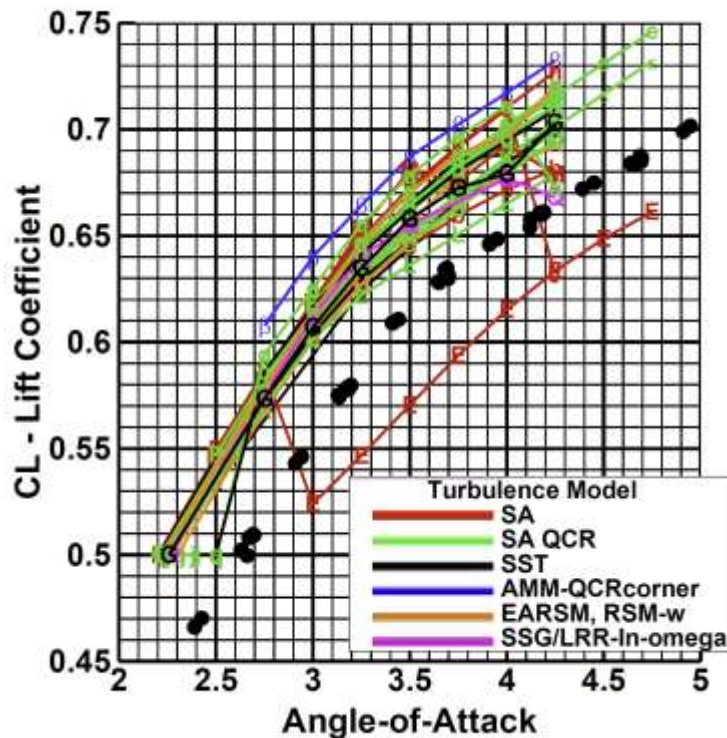

AIAA 7th CFD DPW (2022): Case 2a

- Wing-Body static aeroelastic/buffet study:
 - $M = 0.85$; $Re = 20$ million; Alpha sweep, 2.50° to 4.25° in 0.25° increments
- Investigate CFD predictions where significant flow separation is expected
 - 29 datasets; six turbulence models

NASA Common Research Model (CRM)

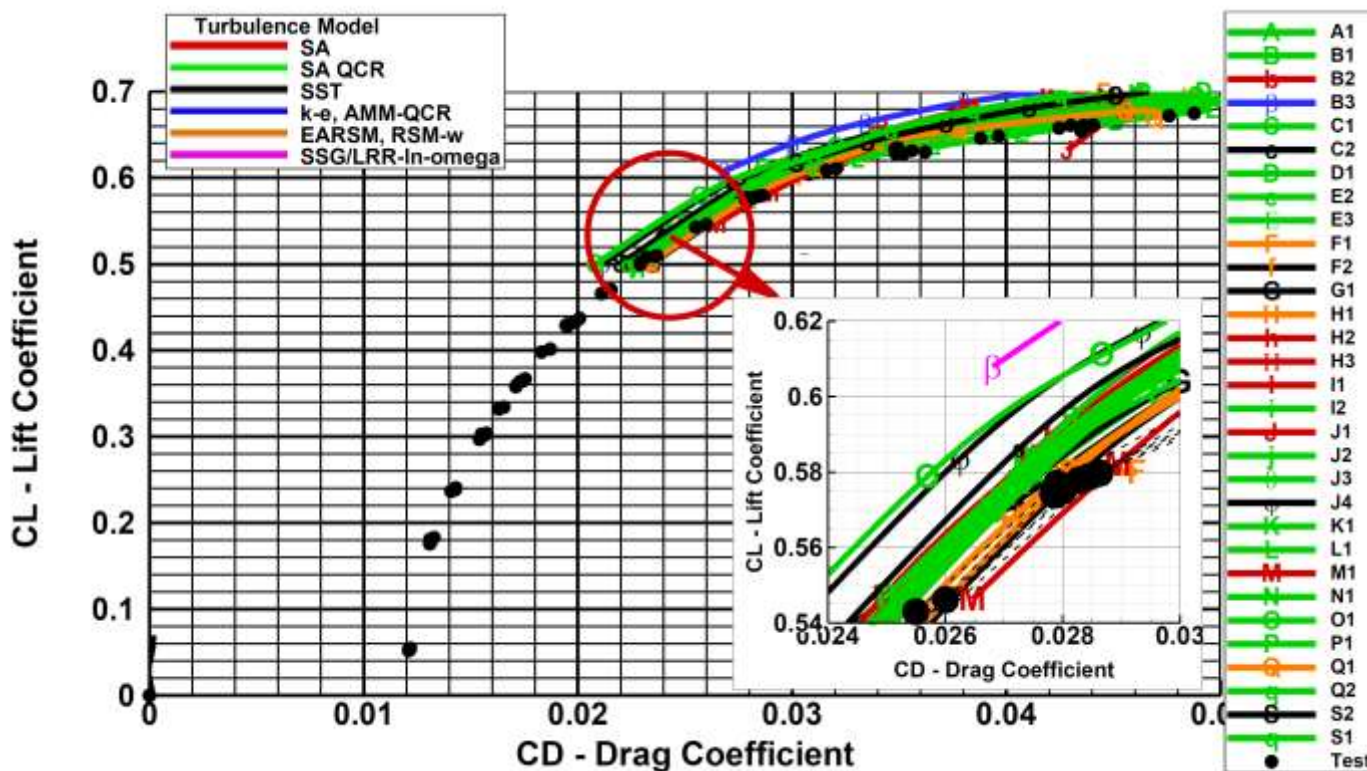

Drag characteristics plotted in terms of idealized profile drag: $C_{DP} = C_D - C_L^2 / (\pi AR)$

Assessment of RANS Predictions: High-Lift Configurations

AIAA High Lift Prediction Workshops (HLPWs)

- **Formally initiated in 2009**; four (4) workshops to date: 2010, 2013, 2017, 2022; numerous publications
- **Primary Goal:** *Assess the numerical prediction capability (mesh, numerics, turbulence modeling, high-performance computing requirements, etc.) of current-generation CFD technology for swept, medium/high-aspect ratio wings in landing/takeoff (high lift) configurations.*
- **Test Cases:** *Variants of commercial transport configurations; subsonic flows; variety of grid systems and flow solvers; multiple turbulence models*
- **Interesting Findings from 3rd HiLiftPW:**
Rumsey et al, AIAA 2018-1258
 - JAXA Standard Model High-lift Configuration with and without Pylon/Nacelle
 - ✓ *Fairly tight clustering of results in the linear lift-curve range, and very large scatter in results near maximum lift*
 - ✓ *Differences between nacelle/pylon on and off were well predicted in general*
 - ✓ *Significant influence of grid for the solutions near maximum lift*
 - ✓ *Transition model results were inconsistent near maximum lift; reasonable results for the wrong reasons!*

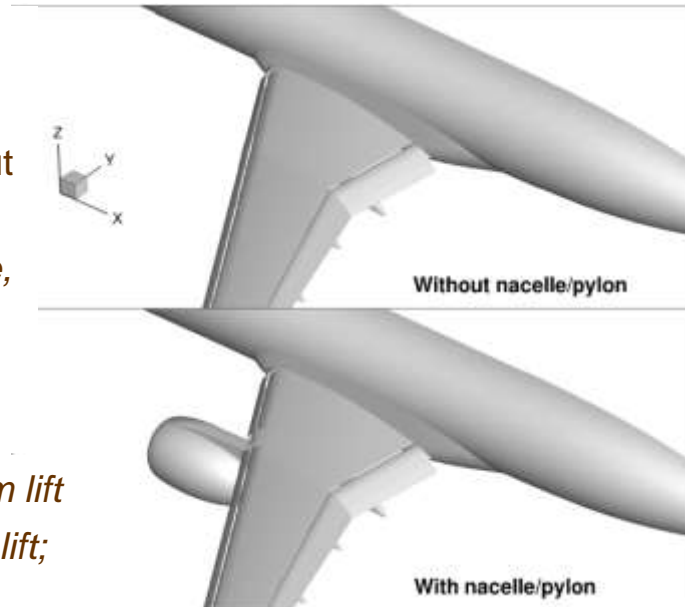

Two Key Factors Hamper Credibility of RANS Predictions

1. Numerical Models

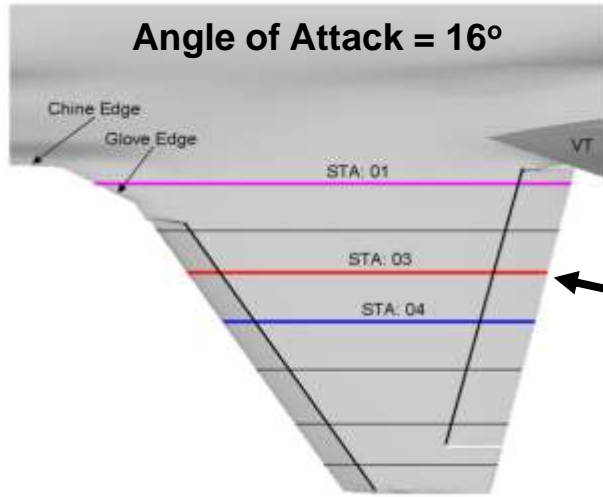

Example: Solution sensitivity to compression factor in limiter function in MUSCL * scheme of Falcon V3.4 code

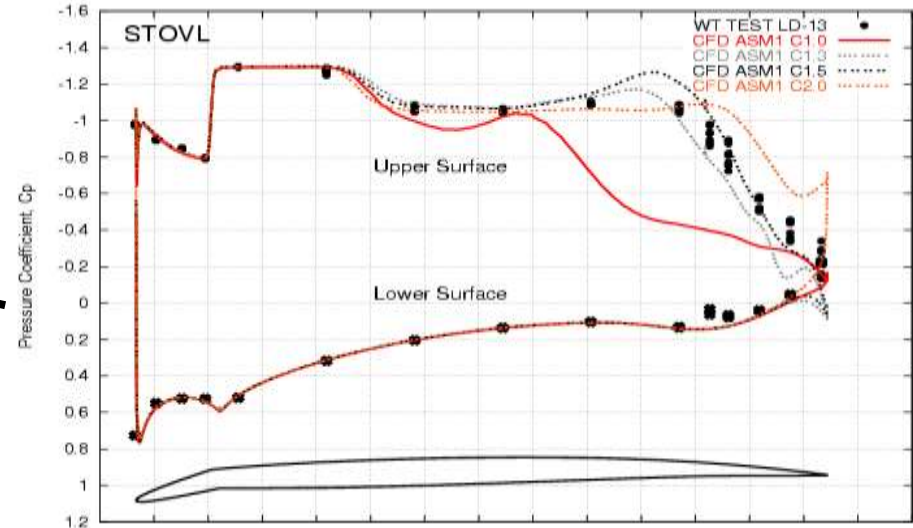

2. Turbulence Models

Example:
Solution
Sensitivity to
Turbulence
Modeling

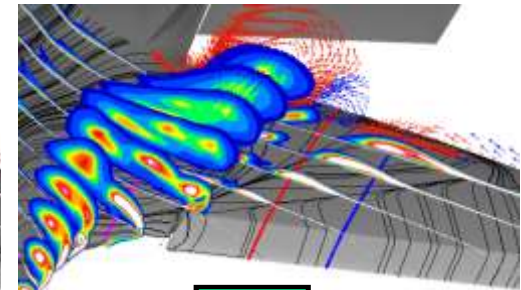
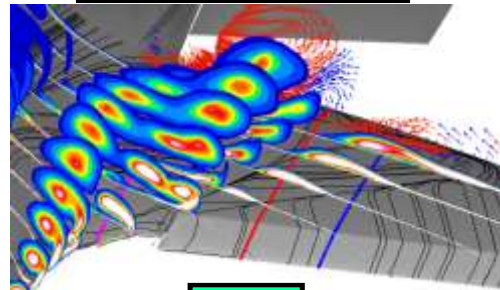
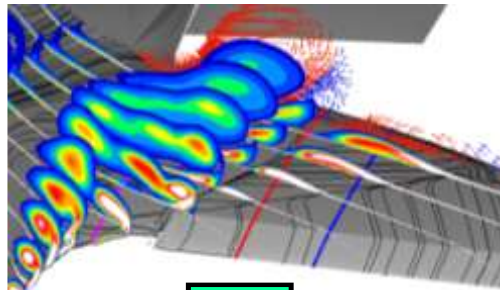

VORTICITY MAGNITUDE

“All Models are Wrong, But Some Models are Useful!” -- George Box, 1997

ASM - Algebraic Stress Model

**Monotonic Upstream-centered Scheme for Conservation Laws*

No Shortage of Grid Types

To Discretize the Spatial Domain for Numerical Modeling of Euler/RANS PDEs

Structured Grid

- quadrilateral (2D)/ hexahedral (3D) cells
- structured data connectivity

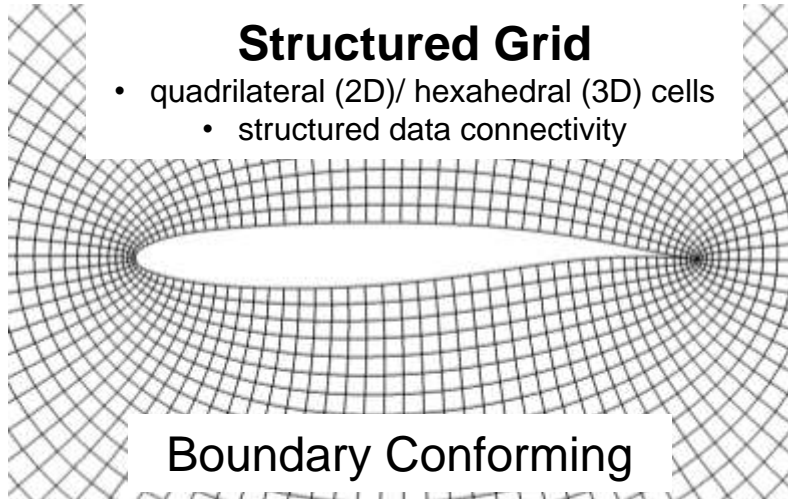

Boundary Conforming

Unstructured Grid

- triangular (2D)/ tetrahedral (3D) cells
- unstructured data connectivity

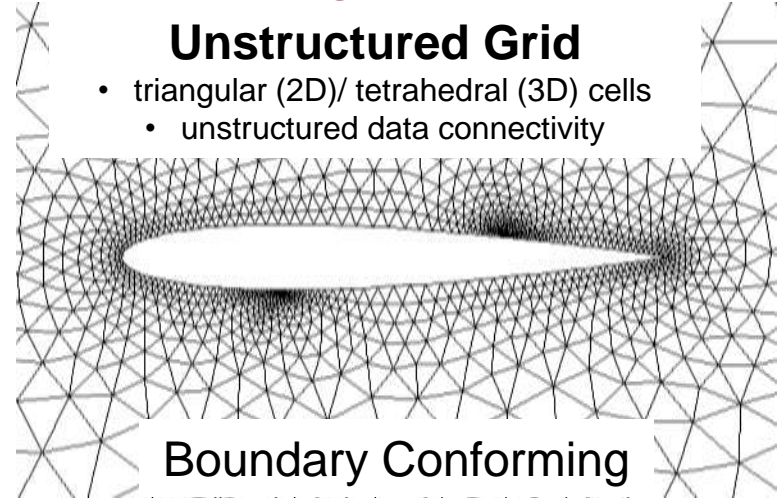

Boundary Conforming

Hybrid Grid

structured + unstructured grids

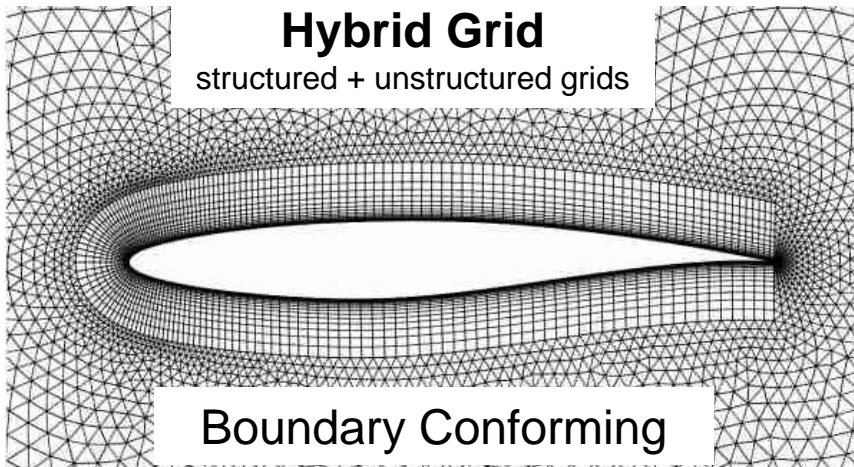

Boundary Conforming

Cartesian Grid

- Square (2D)/ cubic (3D) cells
- unstructured data connectivity

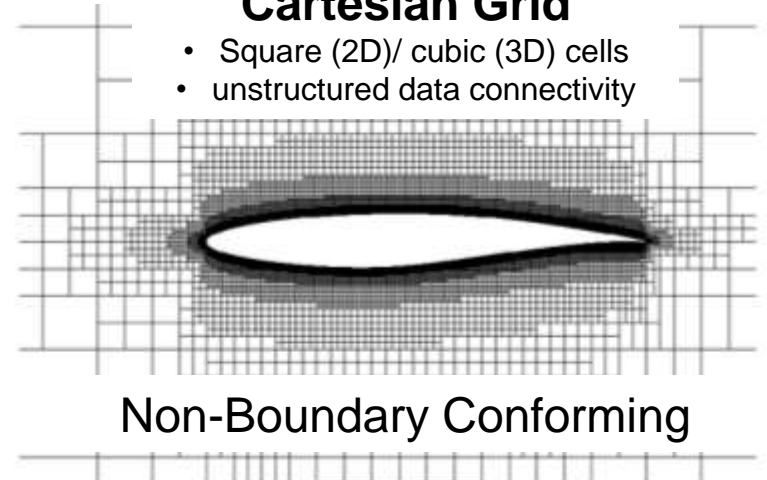

Non-Boundary Conforming

Discretization errors contribute to differences between computed and exact solutions

Difficult to Assess Errors: Exact Solution Not Known a Priori

No Shortage of Numerical Algorithms

For solving Euler & RANS PDEs on Different Types of Grids!

Year	Developer(s)	Scheme
1969	MacCormack	Two stage scheme for hyperbolic equations
1973	Boris & Book	Flux Corrected Transport (FCT) oscillation control via slope limiters
1974	Van Leer	Higher-order Godunov scheme - MUSCL
1981	Steger & Warming	Flux splitting
1981	Jameson, Schmidt, Turkel	Shock capturing via controlled diffusion – full convergence to steady state
1981	Ni	Multigrid Euler solver
1983	Roe	Approximate Riemann solver
1983	Harten	Theory of Total Variation Diminishing (TVD) schemes
1983	Jameson	Agglomeration multigrid full approximation storage (FAS) scheme for Euler equations
1985-86	Jameson, Baker, Weatherill	Airplane Code: 3D Euler equations on unstructured mesh – edge based data structure
1986-88	Yoon-Jameson	Lower-Upper Symmetric Gauss Seidel (LU-SGS) scheme
1987	Harten, Engquist, Osher, Chakravarthy	Essentially Non-Oscillatory (ENO) scheme
1990	Cockburn & Shu	Local Discontinuous Galerkin (LDG) method
1991	Jameson	Multigrid dual time stepping scheme for unsteady flow
1993	Liou	Advection Upstream Splitting Method (AUSM) scheme
1994	Jameson	Theory of Local Extremum Diminishing (LED) scheme
1994-96	Liu, Osher, Chan, Shu	Weighted ENO (WENO) scheme
2001	Jameson-Caughey	Nonlinear Symmetric Gauss-Seidel (SGS) multigrid scheme

Minimize Truncation, Dispersive, and Dissipation Errors

No Shortage of Turbulence Models For RANS Equations

- **Zero-equation models**
 - Cebeci-Smith (1967) and Baldwin-Lomax (1978): *two layer, algebraic*
- **Half-equation models**
 - Johnson-King (1985): *ODE to specify shear stress level*
- **One-equation models**
 - Baldwin-Barth (1990) and Spalart-Allmaras (1992): *turbulent kinetic energy*
- **Two-equation models**
 - Jones-Launder (1972): *k - ε (turbulent kinetic energy and turbulent dissipation)*
 - Wilcox (1988): *k - ω* ; Smith (1990): *k - kl* ; Menter (1993): *SST* k - ω*
- **Explicit Algebraic Reynolds Stress Models (EARSM or ASM)**
 - Gatzki-Speziale (1993); Girimaji (1996)
- **Reynolds Stress Transport Models (RSTM or RSM)**
 - Speziale-Sarkar-Gatski (1991)

“It is quite clear that no model is universal, giving good results for all flows of interest.”

Peter Bradshaw, FRS, Imperial College & Stanford, 1999

Why Turbulence Modeling is a Huge Challenge?

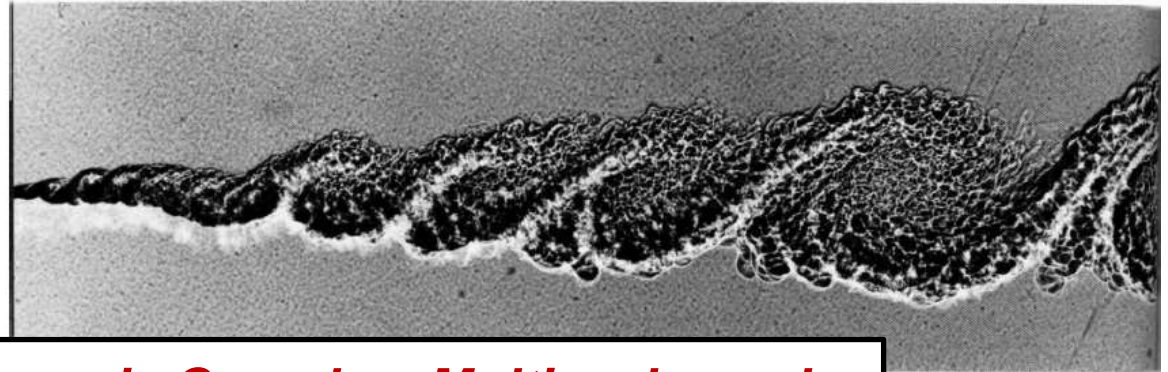
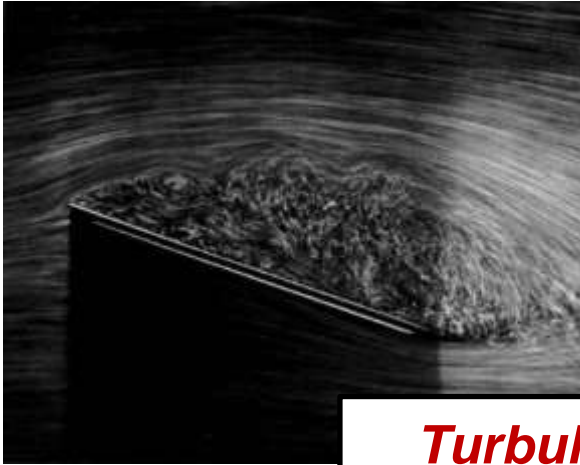

Turbulence is Complex, Multiscale, and Nonlinear with Flow-dependent Features

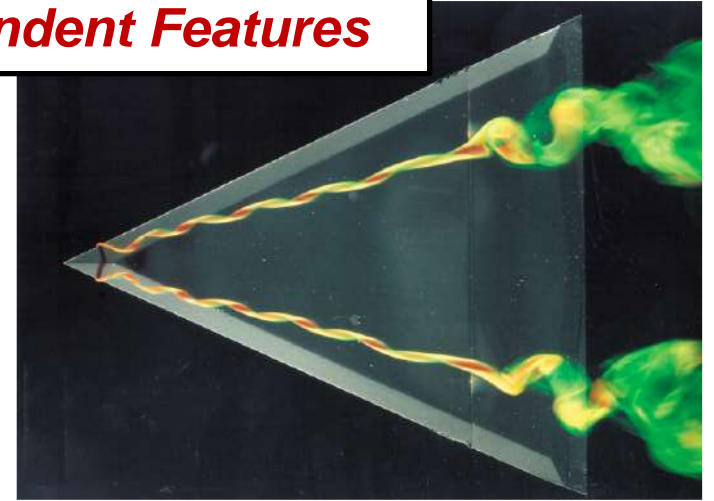

Accurate Modeling of Complex, Multiscale, Nonlinear Phenomena with a Few Free Parameters is an Extremely Long Shot Indeed

Fundamental Nature of Turbulence

*“big whirls have little whirls
that feed on their velocity,
and little whirls have lesser whirls
and so on to viscosity”*
Lewis F. Richardson, 1922

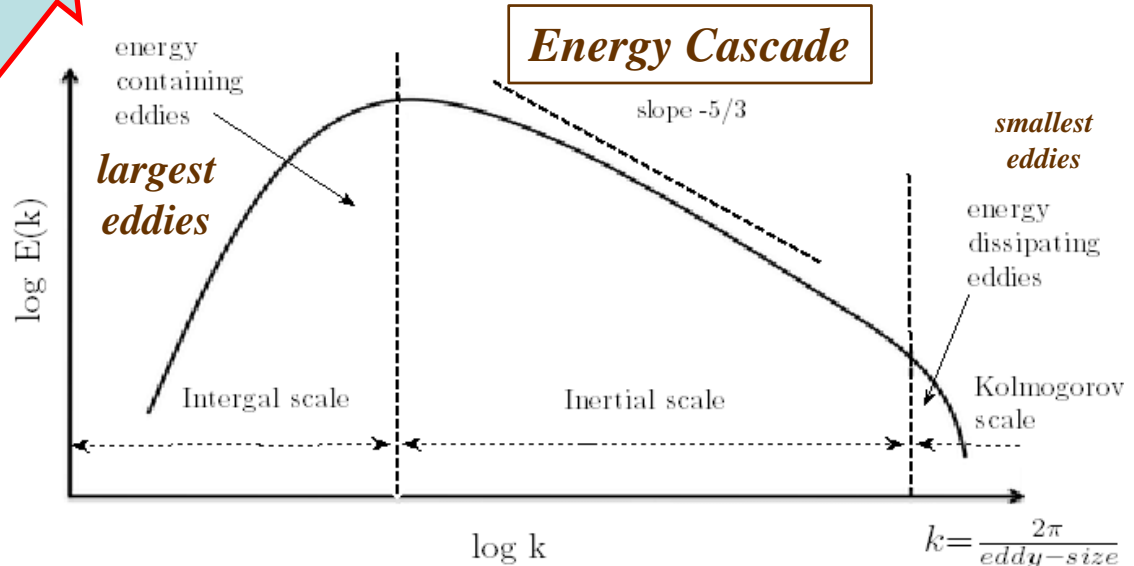
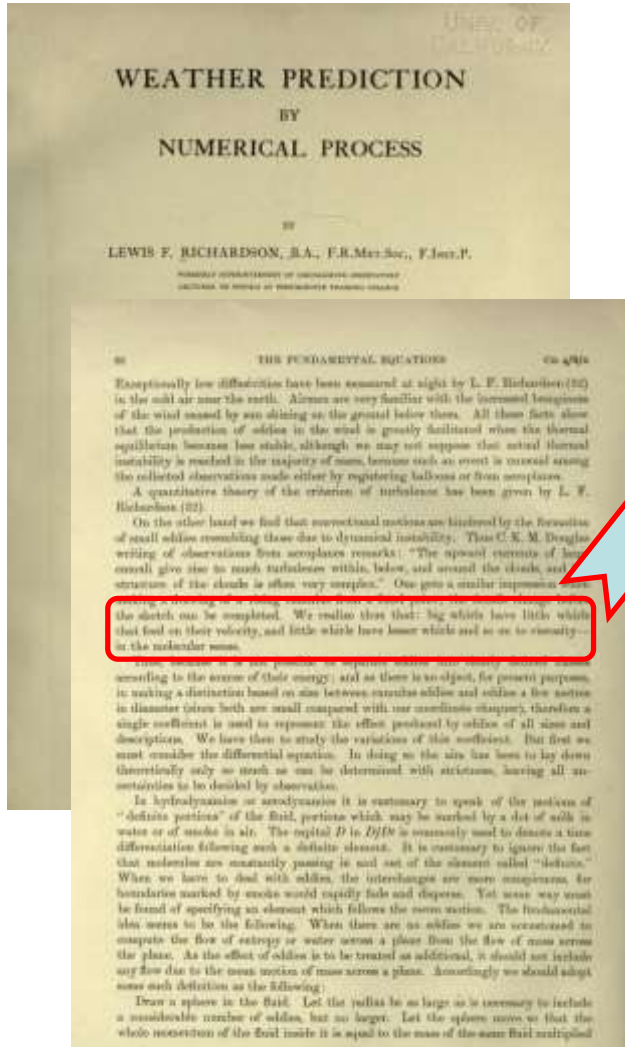

**Multiscale in
Space and Time!**

**Ratio of the Largest to Smallest Length Scale in
Turbulent Flows is $\sim Re^{3/4}$
(Re based on the largest eddy)**

How Complex is Turbulence?

*"I am an old man now, and when I die and go to Heaven there are two matters on which I hope for enlightenment. One is quantum electrodynamics, and the other is the **turbulent motion of fluids**. And about the former I am really rather optimistic."*

Sir Horace Lamb

Address to British Association for the Advancement of Science
London, U.K., 1932



27 Nov 1849 – 4 Dec 1934



Leonardo da Vinci, Flow behind obstacle, **ca. 1510 – 1513**, (from Royal Collection Trust, London, UK)

***Turbulence Has Been
the Bane of
Fluid Dynamicist's
Existence—Seemingly
Forever!***

What's the Dominant Contributor to Error in RANS Solutions?

Is it the Mesh, the Solver, or the Turbulence Model?

Ollivier-Gooch, AIAA 2019-1334

Interesting Findings from ["Crude"] Statistical Analysis

- **Approach:** 39 datasets from Third High-Lift Prediction Workshop (2017) and 31 datasets from Fifth Drag Prediction Workshop (2016) matched into groups based on three primary variables: mesh, flow solver, and turbulence model.
- **"Crude" statistical analysis** due to sparse amount of data in each group.
- **Qualitative Conclusions**
 - **Mesh and turbulence model appear to have about equally large impacts on outputs.**
 - ✓ Results of different mesh sets with the same flow solver and turbulence model differed about as much as the average results for the three groups varied from each other!
 - Even with relatively fine meshes used, there are still **flow features resolved by some meshes and not others.**
 - **Flow solver is at least as big a difference as other factors.**
 - ✓ Community needs to do a better job of *verification* of numerical model and turbulence model implementations.
 - **User selected input parameters can cause significant variation in output values.**
 - ✓ Improved user training can help.

Author's Assessment of the Effectiveness of RANS-based ACA

*RANS-based ACA is Unlikely to be Fully Effective
Anytime Soon, If Ever!*

*With Advances in High Performance Computing (HPC) and
Numerical Modeling, Effectiveness of RANS-based ACA Will
Steadily Increase, But RANS Will Not Produce Credible Data
Due to Turbulence [and Transition] Modeling Deficiencies.*

*“It is the mark of an educated man to
look for precision in each class of
things just so far as the nature of
the subject admits.” – Aristotle*



An Expert's Assessment

“...the state of aeronautical CFD makes difficult to evade the conclusion that a decisive improvement in turbulence accuracy must be achieved before CFD becomes general.”

“...the author [Spalart] deems it unlikely that a RANS model, even complex and costly [RSTM], will provide the accuracy needed in the variety of separated and vortical flows we need to predict.”

“...it is more than plausible that Reynolds averaging suppresses too much information, and that the only recourse is to renounce it to some extent, which means calculating at least the largest eddies simply for their nonlinear interaction with the mean flow.”

Philippe R. Spalart



Senior Technical Fellow
Boeing Commercial Airplanes

Section 6.1

Overarching Takeaways

“What We Simulate is Not Reality Itself, But Reality Determined by Our Models”

***Prediction of Aerodynamic Characteristics
Isn't That Hard...Making Credible Prediction Is!
And It's Really Hard Under Stringent Cost and Schedule
Constraints!***

Section 6.1: Key Takeaways (1 or 2)

- Impressive RANS-based ACA capability demonstrations in the 2000s, but **effectiveness ‘Less Than Satisfactory’**
- Reliable use of RANS limited to cruise part of flight envelope—hence less than satisfactory effectiveness (Boeing Assessment, 2005)
- RANS predictions not always credible, especially for complex flows dominated by separation and free-vortices (NATO RTO Assessment, 2012)
- **Overarching challenge for RANS-based ACA: PRODUCING CREDIBLE SOLUTIONS**
- Aerospace Professional Community initiatives to systematically assess RANS CFD capabilities and shortcomings
 - AIAA CFD Drag Prediction Workshops—the first one in 2001
 - *Accurate prediction of drag is of critical importance to design teams*
 - AIAA High Lift Prediction Workshops—the first one in 2009
- **Two factors hamper credibility of solutions:**
 - (1) Numerical Models; and (2) Turbulence Models
- **Numerical Models—No shortage of options for grids to discretize spatial domain, and for numerical algorithms to solve Euler/RANS PDEs on the various types of grids**
 - *Solution of discretized equations is not necessarily a solution of the differential equation!*

Section 6.1: Key Takeaways (2 of 2)

- **Turbulence Modeling**
 - No shortage of turbulence models ranging from simple algebraic to complicated Reynolds stress transport (RSTM)
 - Accurate modeling of Complex, Multiscale, Nonlinear turbulence using a few free parameters is an extremely long shot indeed
- **RANS-based ACA is Unlikely to be Fully Effective Anytime Soon, If Ever!**
 - *“...[Spalart] deems it unlikely that a RANS model, even complex and costly [RSTM], will provide the accuracy needed in the variety of separated and vortical flows we need to predict.”*

So what are the Prospects for Fully Effective ACA?

We address this question in the next section.

BIBLIOGRAPHY

SECTION 6

6 ACA Effectiveness: Status and Prospects (2000-20xx)

6.1 Assessment of Effectiveness (2000–2020)

- 6.1.1 Tinoco, E., Bogue, D., Kao, T., Yu, N., Li, P., and Ball, D., “Progress toward CFD for full flight envelope,” *The Aeronautical Journal*, Vol. 109, Issue 1100, pp 451-460. <https://doi.org/10.1017/S0001924000000865>
- 6.1.2 Frink, N., Tormalm, M., and Schmidt, S., “Three Unstructured Computational Fluid Dynamics Studies on Generic Uninhabited Combat Air Vehicle,” *AIAA Journal of Aircraft*, Vol. 49, No. 6, Nov-Dec 2012, pp 1619-1637.
- 6.1.3 Levy, D.W., Laflin, K.R., Tinoco, E.N., Vassberg, J.C., Mani, M., Rider, B., Rumsey, C.L., Wahls, R.A., Morrison, J.H., Brodersen, O.P., Crippa, S., Mavriplis, D.J., and Murayama, M., “Summary of Data from the Fifth Computational Fluid Dynamics Drag Prediction Workshop,” *Journal of Aircraft*, Vol. 51, No. 4, July-August 2014, pp 1194-1213.
- 6.1.4 Raj, P., “CFD for Aerodynamic Flight Performance Prediction: From Irrational Exuberance to Sobering Reality (Invited),” 5th Symposium on Integrating CFD and Experiments in Aerodynamics, Tokyo, Japan, October 3-5, 2012.
- 6.1.5 Wilson, C.M., “F-22 Aerodynamics: Prediction vs. Flight,” NASA/DoD Workshop on Aerodynamic Flight Prediction, Williamsburg, VA, 19-21 November 2002.
- 6.1.6 Giunta, A.A., Golividov, O., Knill, D.L., Grossman, B., Haftka, R.T., Mason, W.H., and Watson, L.T., “Multidisciplinary Design Optimization of Advanced Aircraft Configurations,” MAD Center Report 96-06-01, Virginia Tech, Blacksburg, VA.
- 6.1.7 Tinoco, E.N., Brodersen, O.P., Keye, S., Laflin, K.R., Feltrop, E., Vassberg, J.C., Mani, M., Rider, B., Wahls, R.A., Morrison, J.H., Hue, D., Roy, C.J., Mavriplis, D.J., and Murayama, M., “Summary Data from the Sixth AIAA CFD Drag Prediction Workshop: CRM Cases,” *Journal of Aircraft*, Vol. 55, No. 4, July-August 2018, pp 1352-1379.
- 6.1.8 Tinoco, E.N., Brodersen, O.P., Keye, S., Laflin, K.R., Vassberg, J.C., Rider, B., Wahls, R.A., Morrison, J.H., Pomeroy, B.W., Hue, D., and Murayama, M., “Summary Data from the Seventh AIAA CFD Drag Prediction Workshop,” AIAA 2023-3492, AIAA Aviation Forum, June 12-16, 2023, San Diego, California.
- 6.1.9 Rumsey, C.L., Slotnick, J.P., and Sclafani, A.J., “Overview and Summary of the Third AIAA High Lift Prediction Workshop,” AIAA 2018-1258, AIAA SciTech Forum, Kissimmee, Florida, 8-12 January 2018.
- 6.1.10 Wooden, P.A., Smith, B.R. and Azevedo, J.J., “CFD Predictions of Wing Pressure Distributions on the F-35 at Angles-of-Attack for Transonic Maneuvers,” AIAA-2007-4433, 25th Applied Aerodynamics Conference, Miami, Florida, 25-28 June 2007.
- 6.1.11 Karman, S.L., Wyman, N., and Steinbrenner, J.P., “Mesh Generation Challenges: A Commercial Software Perspective,” AIAA-2017-3790, 23rd AIAA Computational Fluid Dynamics Conference, A6.1ATION Forum, Denver, Colorado, 5-9 June 2017.
- 6.1.12 Jameson, A., “Computational Fluid Dynamics and Airplane Design: Its Current and Future Impact,” Lecture Slides, University of Cincinnati, February 28, 2008.

BIBLIOGRAPHY

SECTION 6.1 (contd.)

- 6.1.13 Bradshaw, P., “The Best Turbulence Models for Engineers,” M.D. Salas et al. (eds.), Modeling Complex Turbulent Flows, Kluwer Academic Publishers, 1999, pp 9-28.
- 6.1.14 Van Dyke, M., “An Album of Fluid Motion,” The Parabolic Press, Stanford, California, 1982.
- 6.1.15 Richardson, L.F., “Weather Prediction by Numerical Process,” The University Press, Cambridge, UK, 1922, p. 66.
- 6.1.16 Sinha, N., “Towards RANS Parameterization of Vertical Mixing by Langmuir Turbulence in Shallow Coastal Shelves,” Ph.D. Dissertation, Nov. 2013. DOI: [10.13140/RG.2.2.26443.90404](https://doi.org/10.13140/RG.2.2.26443.90404)
- 6.1.17 Ollivier-Gooch, C., “Is the Problem with the Mesh, the Turbulence Model, or the Solver,” AIAA 2019-1334, AIAA SciTech Forum, San Diego, California, 7-11 January 2019. <https://doi.org/10.2514/6.2019-1334>
- 6.1.18 Spalart, P.R., “Strategies for turbulence modelling and simulations,” International Journal of Heat and Fluid Flow, 21, 2000, pp 252-263 DOI: [10.1016/S0142-727X\(00\)00007-2](https://doi.org/10.1016/S0142-727X(00)00007-2)

	Slide #
Preface	3
1. Introduction and Scope	11
2. Genesis of Fluid Dynamics (<i>Antiquity to 1750</i>)	52
3. Fluid Dynamics as a Mathematical Science (<i>1750–1900</i>)	77
4. Emergence of Computational Fluid Dynamics (<i>1900–1950</i>)	98
5. Evolution of Applied Computational Aerodynamics (<i>1950–2000</i>)	124
5.1 <i>Infancy through Adolescence (1950–1980)</i>	127
Level I: Linear Potential Methods (LPMs)	127
Level II: Nonlinear Potential Methods (NPMs)	138
5.2 <i>Pursuit of Effectiveness (1980–2000)</i>	163
Level III: Euler Methods	167
Level IV: Reynolds-Averaged Navier-Stokes (RANS) Methods	210
6. ACA Effectiveness: Status and Prospects (<i>2000 and Beyond</i>)	229
6.1 <i>Assessment of Effectiveness (2000–2020)</i>	231
6.2 <i>Prospects for Fully Effective ACA (Beyond 2020)</i>	261
7. Closing Remarks	286
Appendix A	295

Future Prospects of Effective CFD

If RANS cannot provide credible solutions, what are the other options that could possibly be used to computationally simulate turbulent flows?

Typical Commercial Transport Aircraft Wing
 $AR = 12, Re_x = 50$ million

	RANS (Reynolds-Averaged Navier-Stokes)	DES (Detached Eddy Simulation)	LES (Large Eddy Simulation)	DNS (Direct Numerical Simulation)
Level of Empiricism	High	Medium	Low	None
Unsteady Flows	No	Yes	Yes	Yes
# of Grid Points	10^7	10^7 to 10^8	10^{11}	10^{20}
Feasibility Demonstration	1995	2010	2045*	2080*

*Estimated feasibility demonstration time frame assuming Moore's Law will still hold!

Note: Dense grids also need extra time steps—hence *much more computational time!*

DNS, With No Empiricism, Is the Only Option for Fully Effective CFD

DNS and LES Grid Requirements

- **DNS:** Grids must be fine enough to accurately resolve small-scale eddies

DNS computational domain for flat plate turbulent boundary layer $L_x \times \delta \times L_z$

$$\# \text{ of grid points: } N_{DNS} = 0.000153 \frac{L_z}{L_x} Re_{L_x}^{37/14} \left[1 - \left(\frac{Re_{x_0}}{Re_{L_x}} \right)^{23/14} \right]$$

x_0 is streamwise location beyond which flow is turbulent

- **WR-LES** (Wall Resolved LES): small-scale eddies near the wall accounted for by inherent numerical dissipation [aka implicit LES or ILES]
- **WM-LES** (Wall Modeled LES): small scale eddies near the wall modeled using sub-grid-scale (SGS) models

Airfoil: *LES computational domain for turbulent boundary layer, no separation*

Aspect Ratio 4, $Re_{x_0} = 5 \times 10^5$

Re_c	N_{wm}	N_{wr}
10^6	3.63×10^7	5.23×10^7
10^7	8.20×10^8	7.76×10^9
10^8	9.09×10^9	5.98×10^{11}
10^9	9.26×10^{10}	4.34×10^{13}

Haecheon Choi and Parviz Moin, "Grid-point requirements for large eddy simulation: Chapman's estimates revisited" *Physics of Fluids*, 24, Jan 2012

DNS and LES of Flow Past an Airfoil: *An Example*

Selig/Donovan SD7003 Low Reynolds Number Airfoil



Max thickness 8.5% at 24.4% chord

Max camber 1.2% at 38.3% chord

Source: [UIUC Airfoil Coordinates Database](#)

Typical Flow Features

$M = 0.1$ $\alpha = 4^\circ$

- Fairly stable laminar separation bubble on the upper surface
- Transition in shear layer leads to turbulent flow

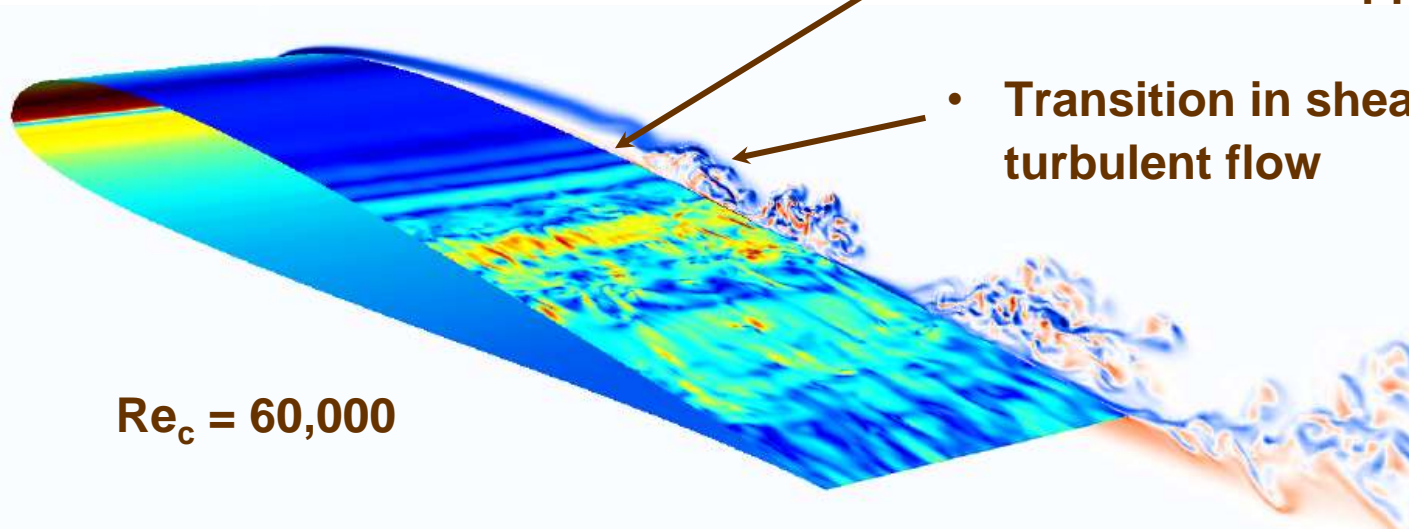

$Re_c = 60,000$

DNS and LES of Flow Past an Airfoil

SD7003 Low Reynolds Number Airfoil

$M = 0.1$, $\alpha = 4^\circ$, $Re_c = 60,000$

AR = 0.2

Far-field boundary at 100 chords

DNS Mesh

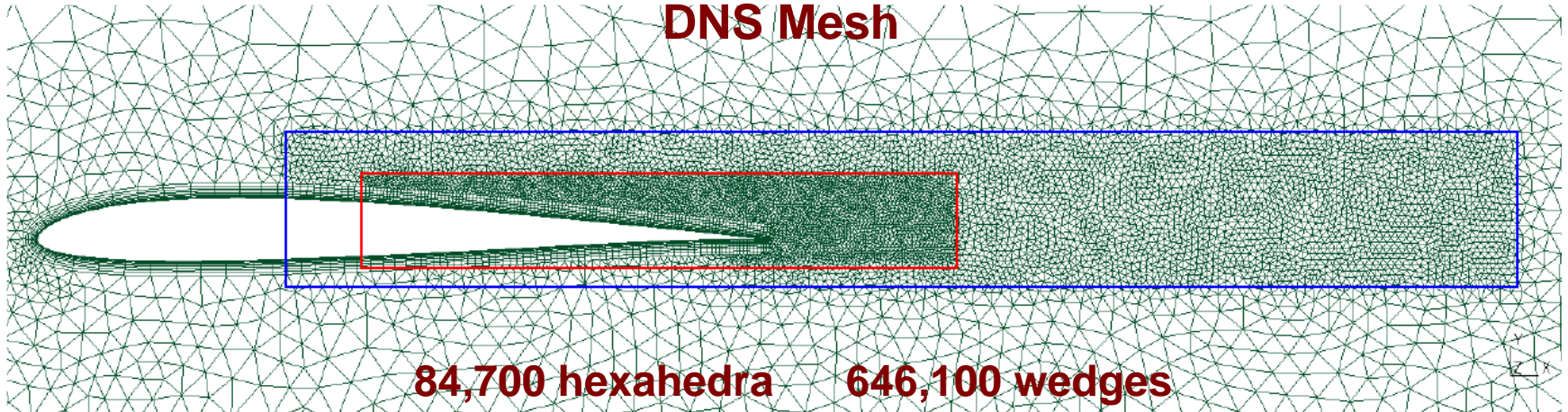

DNS requires much denser grids than LES!

ILES (WR-LES) Mesh

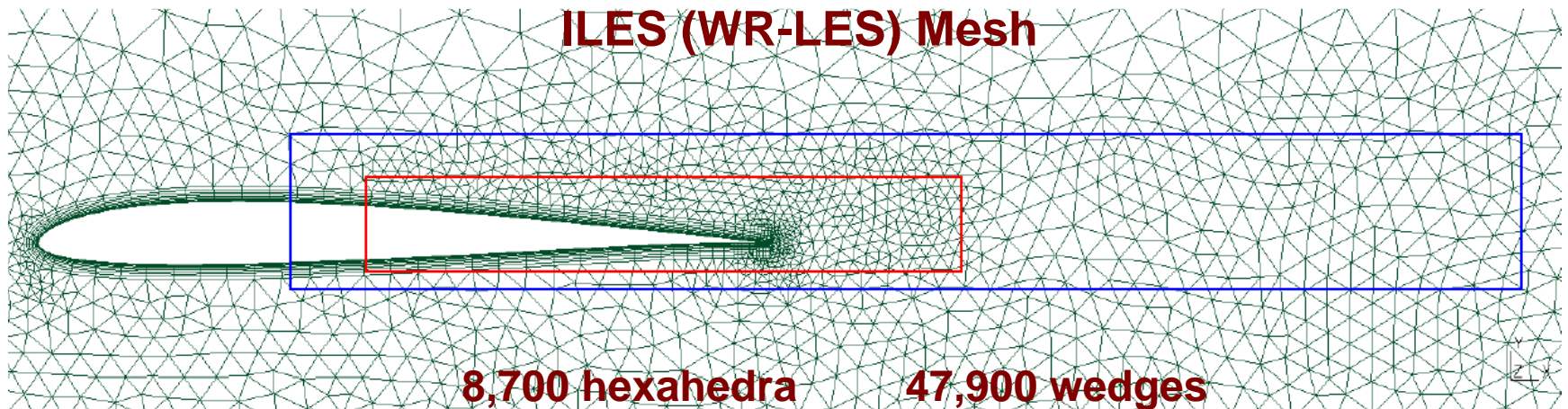

DNS and LES of Flow Past an Airfoil

SD7003 Low Reynolds Number Airfoil

$M = 0.1$, $\alpha = 4^\circ$, $Re_c = 60,000$

Snapshot
of
Velocity
norm

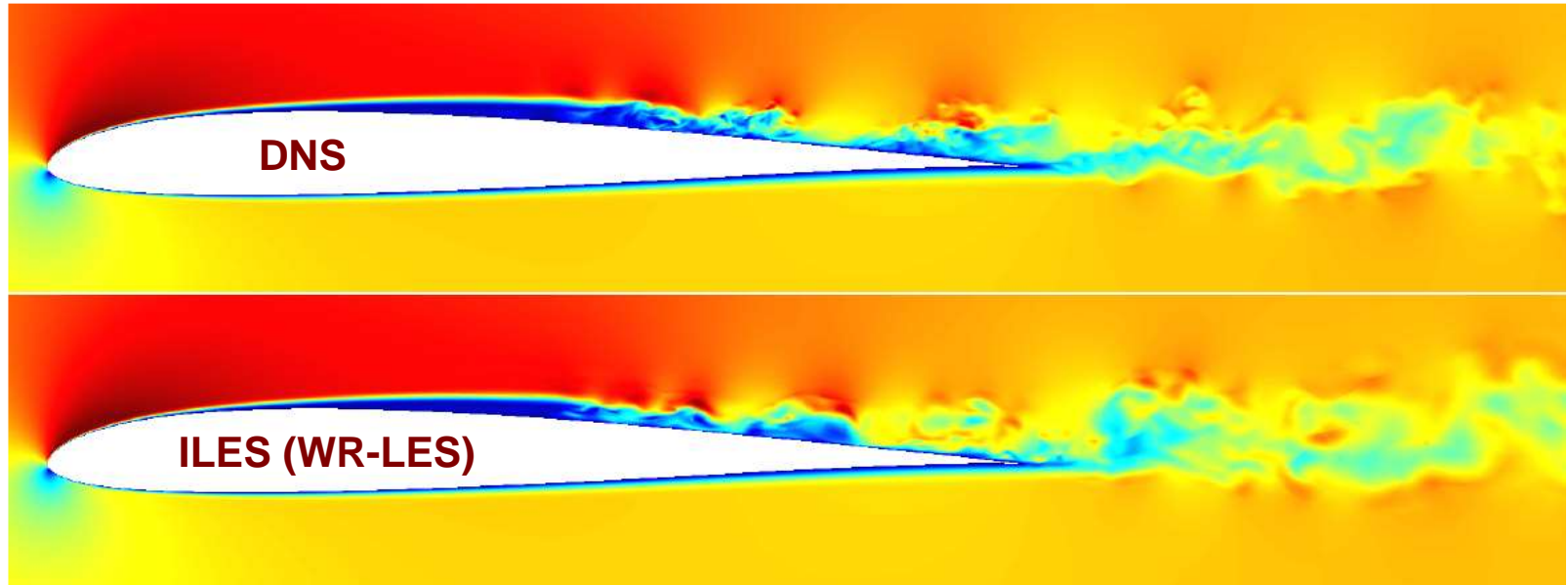

Snapshot
of
Vorticity
norm

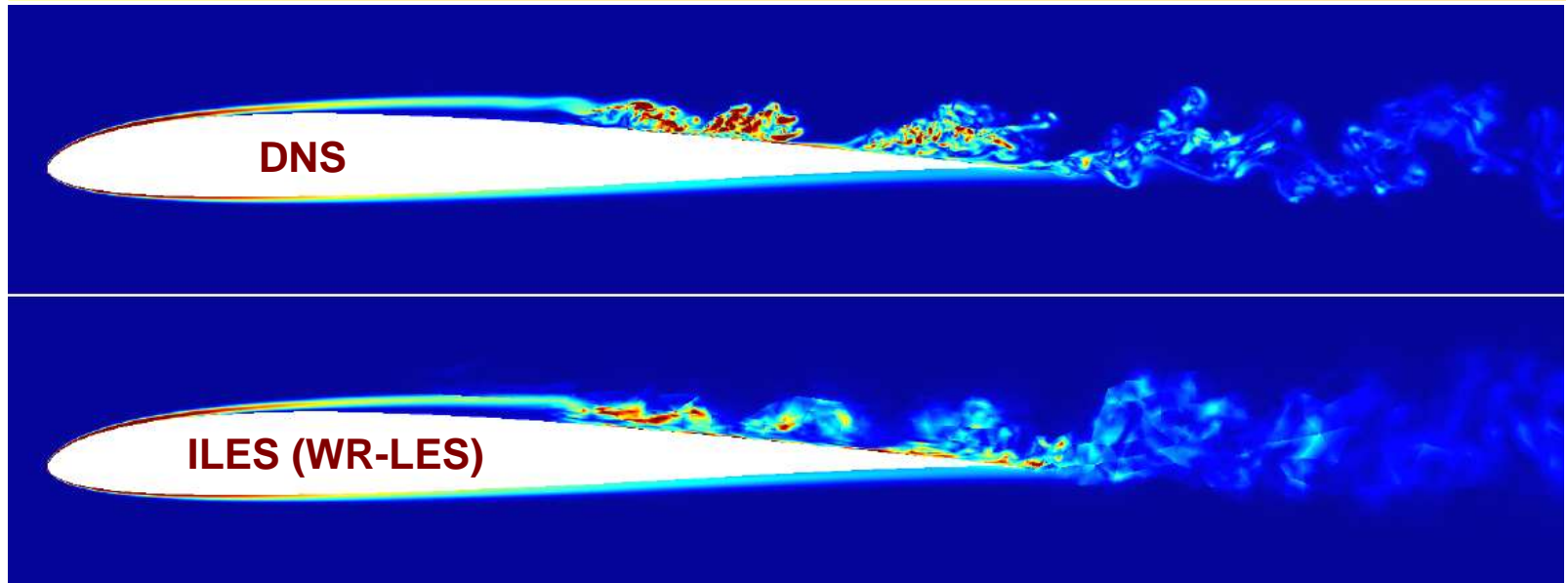

DNS and LES of Flow Past an Airfoil

SD7003 Low Reynolds Number Airfoil

M = 0.1, $\alpha = 4^\circ$, $Re_c = 60,000$

Temporal evolution of lift and drag coefficients

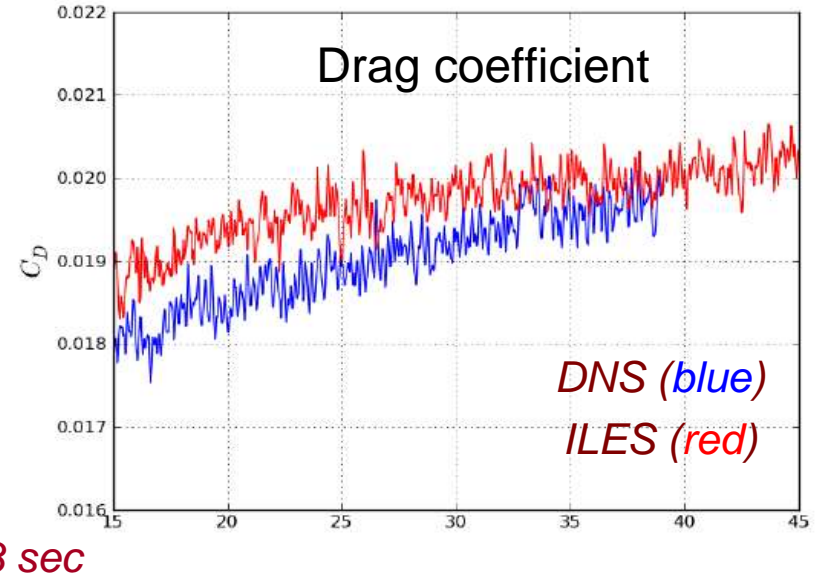
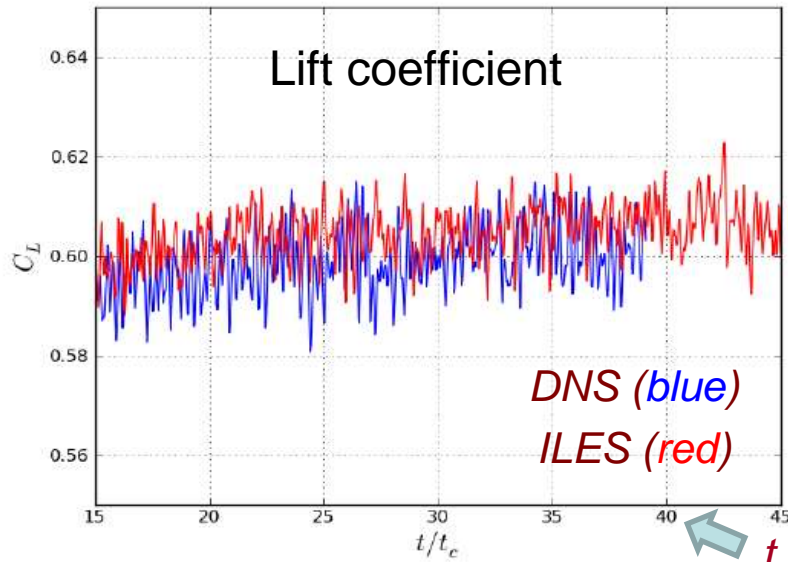

	DNS	ILES	XFoil	Expt. (TU-BS)	Expt. (AFRL)
<i>Freestream Turbulence</i>	0	0	($N_{crit} = 7.5$)	0.08%	~ 0.1%
C_L (mean)	0.602	0.607	0.583	-	
C_D (mean)	0.0196	0.020	0.0181	-	
Separation (x_{sep}/c)	0.209	0.207	0.26	0.30	0.18
Reattachment (x_r/c)	0.654	0.647	0.57	0.62	0.58
CPU-Hrs* for one t_c	11,001	415	-	-	

Note: $t_c = c/U_\infty$ is convective time;
 $t_c = 7.6 \times 10^{-4}$ sec (est.)

DNS took 25X more CPU time
than ILES for one t_c

*16,000 CPUs on "Jugene"
(<https://en.wikipedia.org/wiki/JUGENE>)

DNS can produce credible solutions but it will require incredible reduction in turnaround time and total cost for DNS to be fully effective in meeting aircraft design needs.

Both “A - Acceptance” and “Q - Quality” factors in $E = Q \times A$ need to be simultaneously maximized for Fully Effective ACA based on DNS

Since DNS is not expected to be feasible—even for a wing—until around 2080, how do we improve ACA effectiveness?

Motivation

“...the last decade has seen stagnation in the capabilities used in aerodynamic simulation within the aerospace industry, with RANS methods having become the high fidelity method of choice...”

“...the well-known limitations of RANS methods for separated flows have confined reliable use of CFD to a small region of the flight envelope ...”

NASA/CR-2014-218178

(Published in 2014)



CFD Vision 2030 Study: A Path to Revolutionary Computational Aerosciences

*Jeffrey Slotnick and Abdollah Khodadoust
Boeing Research & Technology, Huntington Beach, California*

*Juan Alonso
Stanford University, Stanford, California*

*David Darmofal
Massachusetts Institute of Technology, Cambridge, Massachusetts*

*William Gropp
National Center for Supercomputing Applications, Urbana, Illinois*

*Elizabeth Lurie
Pratt & Whitney, United Technologies Corporation, East Hartford, Connecticut*

*Dimitri Mavriplis
University of Wyoming, Laramie, Wyoming*

**A Clarion Call to the
Community**

NASA CFD Vision 2030: Roadmap

(Published in 2014)

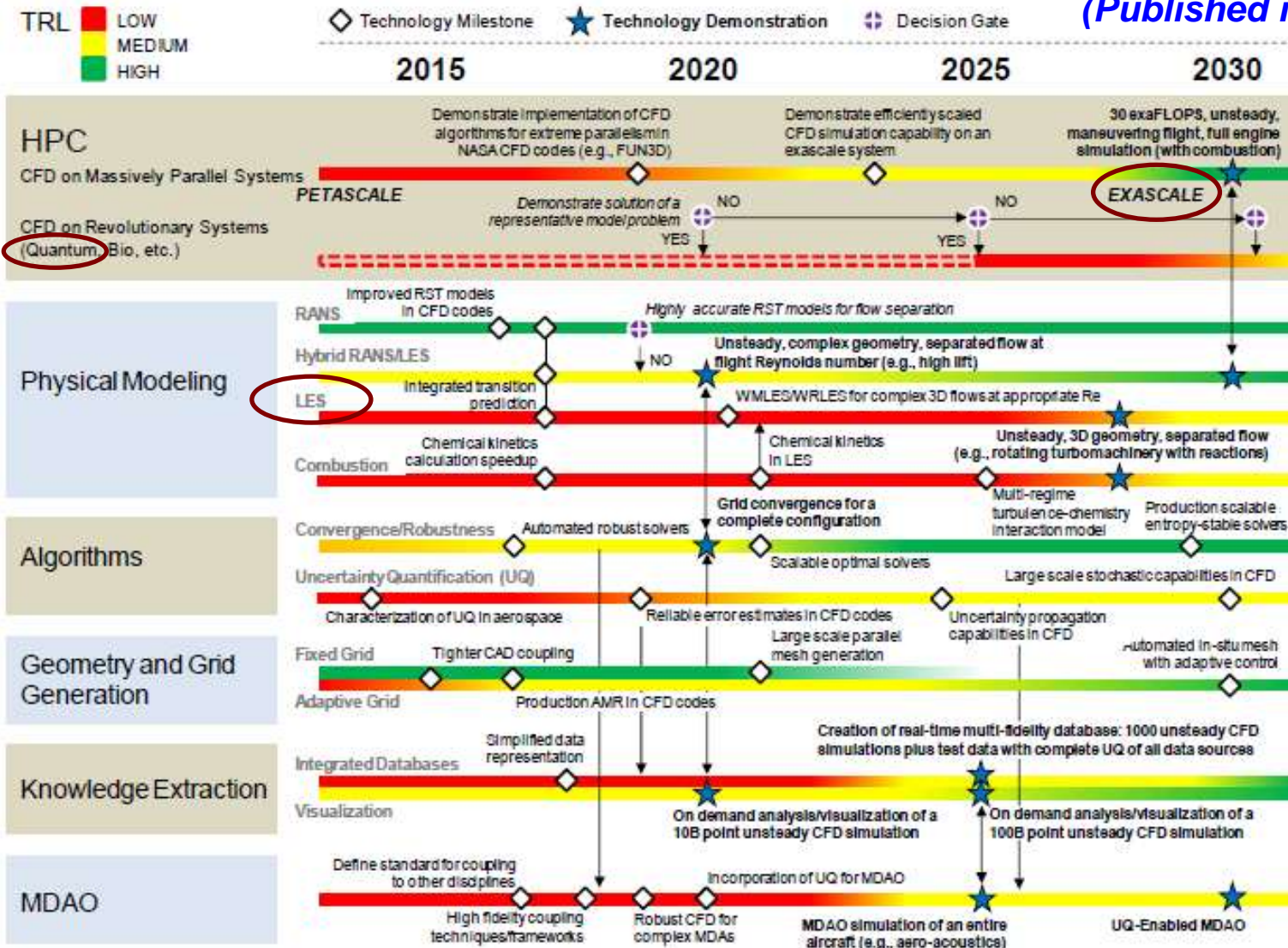

A Comprehensive Plan That Could Significantly Increase ACA Effectiveness by 2050(?)

LES for Increased ACA Effectiveness

Pace of progress closely tied to advances in many key areas

- **Grids:** Methods for rapidly generating very fine, *truly* boundary-conforming grids
- **Models:** Advanced near-wall sub-grid-scale (SGS) models for WM-LES
- **Algorithms:** Higher-order numerical methods that minimize numerical dissipation
- **Software:** Development and implementation of effective strategies for designing computer software that exploits *emerging computer hardware architectures*
- **V&V:** Effective approaches for verification and validation of complex software, and for uncertainty quantification
- **Data Management:** Cost-effective approaches for efficiently managing large amounts of data, and for fast processing of extremely large datasets to extract information of value for ACA engineers
- **Etc., etc.**

• Computer Requirements

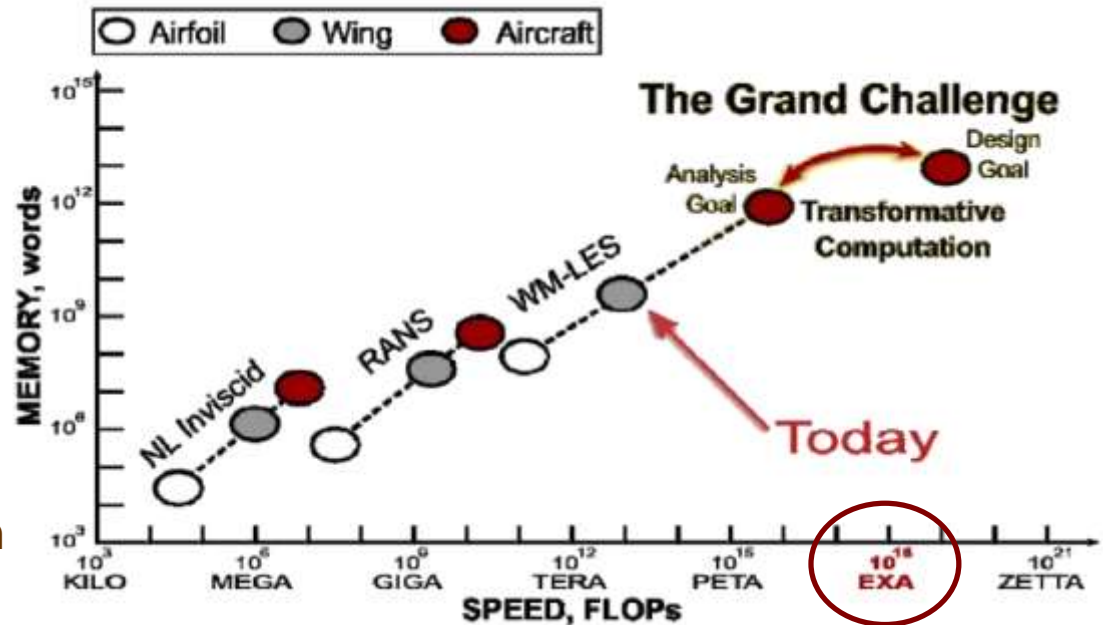

A Midterm Strategy (2050+) At Best

Increase in Digital Computer Peak Speed (1950 - 2020)

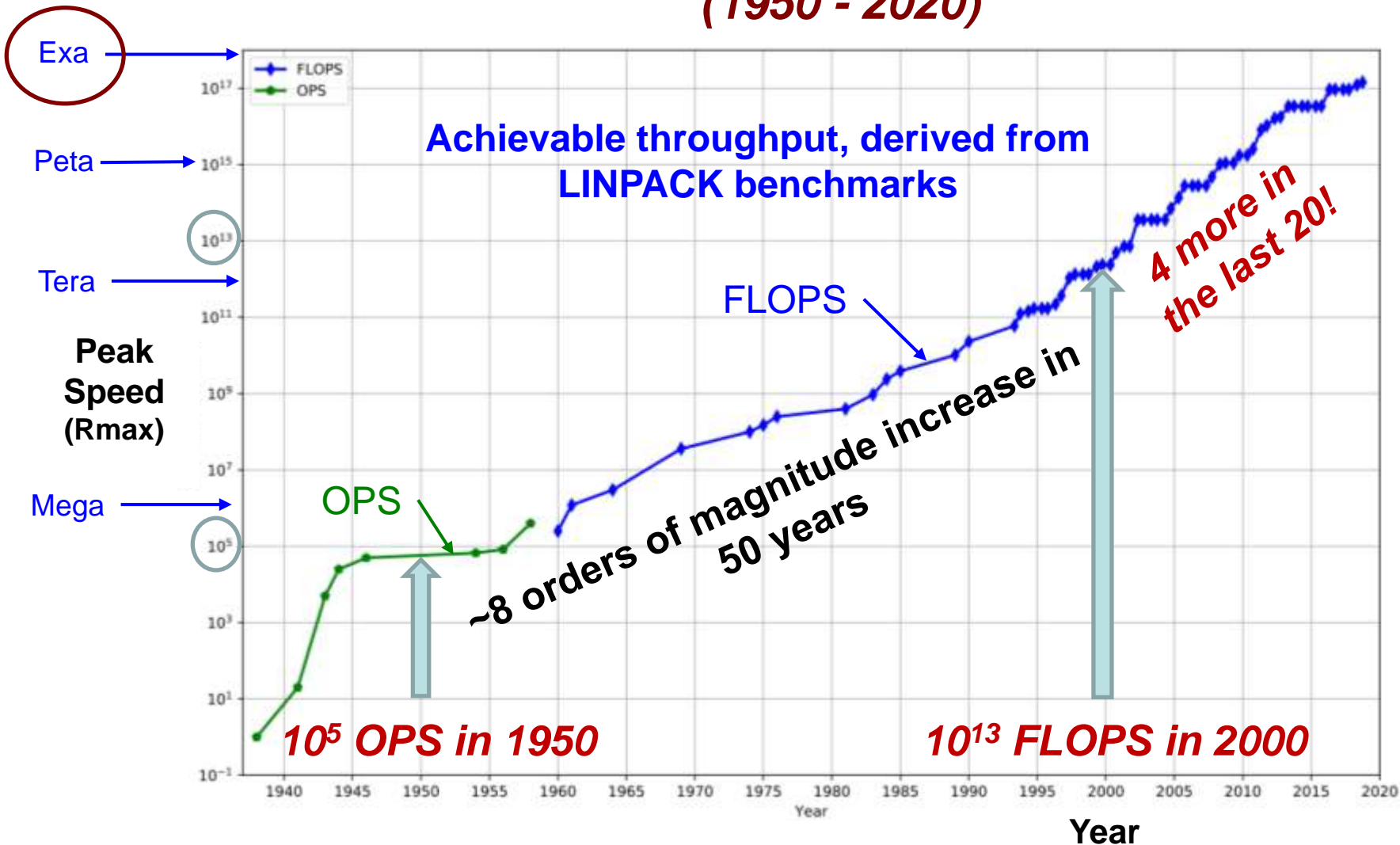

ExaFLOPS Peak Speed is Within Reach—BUT We Need Sustained Speeds at this Level for Practical LES Applications

Current Status of LES

2023

Turbomachinery Flow

Large Eddy Simulation (LES)

Unstructured grid: 1.69×10^9 elements

High order solver: up to 8th order

HPC cores: 19.2 million

HPC performance: 115.8 PetaFLOPS (DP)

Y. Fu, W. Shen, J. Cui, Y. Zheng, et al, Towards Exascale Computation for Turbomachinery Flows, SC'23, November 12-17, 2023, Denver, CO

Gordon Bell Prize nominee

Challenge: Full Aircraft DNS

Full Aircraft

Direct Numerical Simulation (DNS)

Unstructured grid: $> 10^{20}$ elements

HPC cores: ???

HPC performance: ???

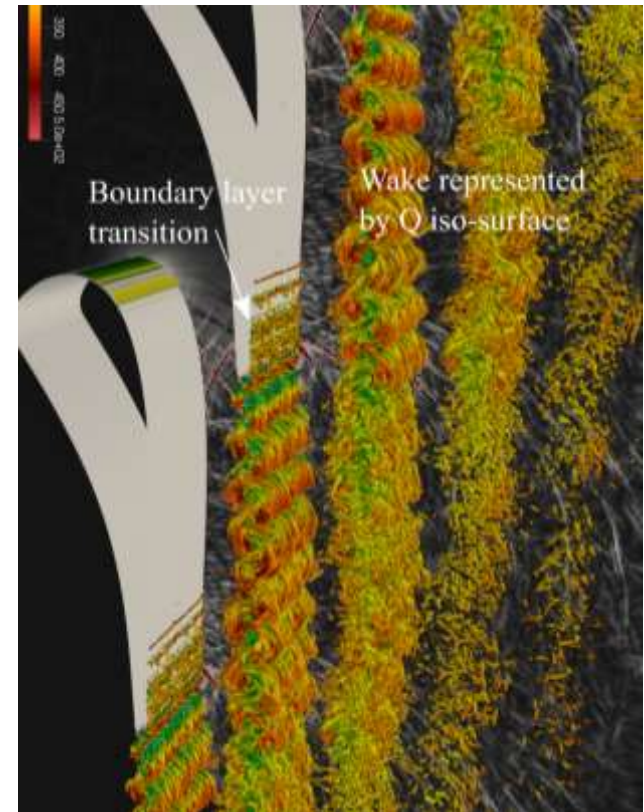

How Do We Get There From Here?

Quantum Computing (QC)

Offers A Ray of Hope!

- **Ongoing Revolutionary Research**

- We can perform 2^N computations simultaneously on a quantum computer of N qubits (*qubits are quantum entities manipulated to act like computer bits*)
- A grid of 2^N elements requires a quantum computer with N qubits

Problem	CFD	Timeframe	HPC cores	QC qubits
Turbomachinery	LES	2023 (now)	19.2 million	30
Full Aircraft	DNS	??? (future)	???	57

- **Quantum-inspired, Hybrid Quantum-Classical, and Quantum Algorithms**

- An order of magnitude faster and cost-effective simulations using quantum algorithms than classical algorithms on today's HPC have been demonstrated
- Quantum algorithms running on simulation platform of HPCs and quantum computers could reduce time and cost by nearly three orders of magnitude!

Potential for DNS of Full Aircraft Using QC Much Sooner Than The 2080s!

Source: Personal Communication, Abhishek Chopra, Founder and CEO, BosonQ Psi
(<https://www.bosonqpsi.com/>)



Conundrum for Today's Engineers

RANS is Here to Stay!

“...engineering calculations will have to be done by Reynolds-averaged methods for the foreseeable future...”

“...computer simulations of eddy motion can and will provide the detailed statistics—above all, the pressure fluctuation statistics—that cannot be adequately measured.”

“...we cannot calculate all flows of engineering interest to engineering accuracy. However, the best modern methods allow almost all flows to be calculated to higher accuracy than the best-informed guess, which means that the methods are genuinely useful even if they cannot replace experiments.”

Excerpts from TURBULENT SECONDARY FLOWS by Peter Bradshaw
Annual Review of Fluid Mechanics, Vol 19, 1987, pp 53-74

Author's Take: “Glass is half full”

Despite relatively low effectiveness for simulating complex flows, RANS methods can, and do, add value if used wisely

The TiCTaC Paradigm for Improving RANS-based ACA Effectiveness

Tightly Coupled Tests and Computations

Devise the best way of *judiciously* coupling wind tunnel testing (WTT) with RANS CFD to deliver credible aerodynamic data—rapidly and affordably

2002: First proposed (Raj)

NASA/DOD Workshop on Aerodynamic Flight Predictions, Williamsburg, VA, USA, Nov 19-21, 2002

Aerodynamic Flight Prediction: A Path Forward

- Goal: Rely on Computational Simulations for Aerodynamic Flight Prediction → **CFD and its Interdisciplinary Extensions**
- Problem: CFD Codes Will NOT Produce Credible Data for Your Application Unless Previously Validated on Same Application
 - Too Many Potential Traps: Computing Systems, Coding Errors, Complexity of Mathematical and Numerical Methods, Modeling Approximations, Inappropriate Use, etc., etc., etc.
- Approach: Develop and Implement "Validation Plan" Targeted at Maximizing Prediction Credibility for Your Application
 - Requires Dedicated Physical Experiments on Relevant Isolated Phenomena to Reduce and Quantify Uncertainties that Contribute to Lack of Confidence in Predictions → **Different Way of Using Wind Tunnels**
 - Sandia National Lab's Accelerated Strategic Computing Initiative Provides a Good Starting Point

Adopt Tightly Coupled Test and Computations (TiCTaC) Concept

2012: Revisited (Raj)

5th Symposium on Integrating CFD and Experiments in Aerodynamics, JAXA, Tokyo, Japan, Oct 3-5, 2012

A Near-term Alternative: TiCTaC (Tightly Coupled Test and Computations)

- **Premise:** CFD Codes Will NOT Produce Credible Data for Your Application Unless Previously Validated on the "Same" Application
- **Approach:** Develop and Implement "Validation Plan" Targeted at Maximizing Prediction Credibility for Your Application
 - Identify the principal source(s) of uncertainty related to modeling of relevant flow physics and numerics
 - Perform dedicated tests for the sole purpose of "refining" modeling parameters
 - Utilize updated models to maximize credibility of CFD simulations

Can We Realize its Enormous Potential in Practice?

2014 & 2016: An updated approach (Raj et al) Applied Aero Conference, Bristol, UK

- Develop and implement *TiCTaC*: leverage complementary strengths of CFD and EFD by exploiting ongoing technological advances in both WTT and CFD
 - ✓ WTT (*Additive Manufacturing, Rapid Prototype Testing, Measurement Techniques*)
 - ✓ CFD (*Grid Adaption, High Performance Computing, Uncertainty Quantification*)

A Near Term "Stopgap" Strategy

No Shortage of CFD Software!

Commercial Codes for Viscous Flow Simulation

A New Paradigm Emerged in the 1980s as an Alternative to Aerospace Industry's Proprietary CFD Development

Software	Developer/ Vendor	Comment
PHOENICS	Spalding/ CHAM Ltd. [1981]	General purpose CFD package consolidating multiple niche codes developed from 1974 thru 1980
FIDAP	Engelman/ FDI Inc. [1982]	General purpose FEM code--incompressible viscous flow
FLUENT	Swithenbank/ Create, Fluent (now ANSYS) [1983]	General-purpose CFD solver on single-block, structured hexahedral grids
FLOW-3D	Hirt/ Flow Science [1985]	Volume-of-Fluid CFD method for free-surface applications
FASTRAN	CFD RC (now ESI Group) [1988]	Density-based, finite-volume code for high-speed flows; coupled 6-DOF allows multiple and moving body simulations
STAR-CD	Grosman/ CD-adapco [1989]	General-purpose finite-volume unstructured-grid method
CFD++	Chakravarthy/ Metacomp [1995]	General-purpose CFD code with wide range of applicability
ACE+	CFD RC (now ESI Group) [1995]	General-purpose CFD code with wide range of applicability
Cobalt	Cobalt Solutions, LLC [2000]	General purpose CFD code for a wide variety of problems
STAR-CCM+	CD-adapco (now Siemens) [2004]	Uses FEM or FV to simulate viscous flow on polyhedral grids

CFD is Now a "Commodity": \$1.75B Revenue in 2019 with Compound Annual Growth Rate (CAGR) of 9%!

“Free” CFD Software!

An Alternative to Proprietary and Commercial CFD

Software	Developer/ Vendor		Comment
POTENTIAL FLOW CODES (PUBLIC DOMAIN)			
AVL	Drela/ MIT	[1995]	Vortex Lattice Method code (http://web.mit.edu/drela/Public/web/avl/)
Tornado	Melin/ KTH	[2009]	VLM code in MATLAB (http://tornado.redhammer.se/index.php)
VSPAero	Kinney/ NASA	[2015]	VLM (http://openvsp.org/wiki/lib/exe/fetch.php?media=vsp_aircraft_analysis_user_manual.pdf)
Panair	Boeing/ PDAS	[2002]	Surface panel method (http://ckw.phys.ncku.edu.tw/public/pub/Notes/Languages/Fortran/FORSYTHE/www.pdas.com/p/anair.htm)
RANS CODES (PUBLIC DOMAIN & OPEN SOURCE)			
TetrUSS	Frink/ NASA	[1998]	Suite of computer programs for CFD simulations using unstructured grids (https://software.nasa.gov/software/LAR-16882-1) US release only
Cart3D	Aftosmis/ NASA	[2000]	Only inviscid flow analysis using Cartesian grids is publicly available (https://software.nasa.gov/software/ARC-14275-1) USG & contractors only
OpenFOAM	OpenCFD/ ESI Group	[2004]	Free, open source software framework for developing application executables using packaged functionality in approx. 100 C++ libraries (https://www.openfoam.com/)
Kestrel	DoD HPCMP/ CREATE™-AV	[2009]	High-fidelity, multi-physics analysis of fixed-wing aircraft (https://www.hpc.mil/program-areas/computational-research-and-engineering-acquisition-tools-and-environments/create-air-vehicles-av)
SU2	Stanford Univ./ SU2 Foundation	[2013]	Collection of C++ and Python software for PDEs and PDE-constrained optimization problems on unstructured meshes (https://su2code.github.io/)

Today's Users Have No Shortage of CFD Codes to Choose from!

Caution for ACA Engineers:

Not all CFD Codes Are Created Equal

- **Developers Typically Claim to Offer ‘Validated CFD Code’**
 - Implies that simulated results can be trusted to accurately predict real-flow characteristics for any configuration. **But ‘validated CFD code’ is a misnomer!**
- **Claims Might be Based on Traditional Code Validation Approach**
 - Correlate computed and test results for a *chosen set of test cases*.
- **But...Traditional Code Validation is of Limited Value**
 - Even extensive correlations of computed and test results on geometries and flow conditions *that differ substantially from those being considered for design* are of limited value.
 - Too Many Potential Traps: *Generation of grid-converged solutions; Availability of on- and off-surface data from the same test; Reynolds number scaling of test data; Accurate matching of boundary conditions; User proficiency; etc., etc., etc.*

*“Commercial CFD packages are often marketed by claiming that a particular code can solve almost every fluid flow problem, while many users, both in industry and academia, stand aloof from quantitative error measures, instead being dazzled by colorful computer generated output.”-- Celik (1993)**

*“Increasing number of industrial companies rely on commercial software to meet their CFD needs... It is no longer possible to teach CFD the traditional way. Instead we should teach our students how to use commercial CFD codes.” -- Pelletier (1998)**

ACA Provides Value to the Customers ONLY IF Engineers Wisely Choose and Apply the “Right” CFD Codes

*Boysan, H.F., Choudhury, D., and Engelman, M.S., “Commercial CFD in the Service of Industry: The First 25 Years,” Notes on Numerical Fluid Mechanics, NNFM 100, Springer-Verlag, 2009, pp. 451-461, Hirschel, E.H. *et al.* (Editors)

ACA Engineers Should Use/Choose CFD Codes Wisely Based on Effectiveness

1. Understand the Customer's Problem

- Develop a *comprehensive* understanding of the scope of customer needs (potential impact of solution, desired level of accuracy, type and amount of data, etc.) and constraints (cost and schedule)

2. Devise a Practical Approach to Solving the Problem

- Examine all four levels of available CFD codes for solving the problem with effectiveness as the key measure of merit
- Choose a code based on customer need and constraints [the type, amount and quality of aerodynamic data required to meet customer needs subject to the specified constraints]

3. Deliver a *Best Solution* that Adds Value

- Provide a solution that *best* meets customer needs while satisfying all constraints

Don't Use a Hammer When You Need a Screwdriver!

A Sage Advice for ACA Engineers As True Today as in 1990—If Not More So

“Aeronautical calculations today rely on the awesome power of the computer. However, as has been observed, power can corrupt. Equipped with an appropriate address book, giving the location and availability of various programs, the aeronautical engineer can now command the solution of a great variety of aerodynamic problems. Moreover, the capacity of the computer has made possible the inclusion of many small physical influences that until now had to be neglected but sometimes create a false impression of high accuracy. However, the basic physical assumptions of calculations, if they are discussed at all, are often not given adequate treatment...”

If ‘computer aerodynamics’ is to realize its full potential, then more attention must be devoted to these underlying principles.”

R.T. Jones, *Wing Theory*, Preface
Princeton University Press, Princeton, New Jersey, 1990

CFD Competency is Necessary, but not Sufficient, to be an Effective Applied Computational Aerodynamics Engineer

It’s the aerodynamics, stupid!*

*from famous snowclone “*It’s the economy, stupid.*” James Carville, 1992

Robert T. “RT” Jones



Premier Aeronautical Engineer
28 May 1910 – 11 Aug 1999

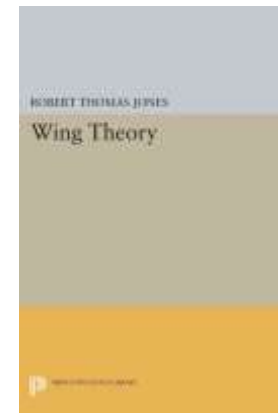

Talent Trumps Tools—*Everyday of the Week!*

Blackbirds: A Unique Technological Achievement

“Perhaps the most important characteristic of the Blackbirds is the fact that they were designed before the advent of supercomputing technology. A small team of talented engineers, using slide-rules and know-how, built a family of operational airplanes capable of flying faster and higher than any air-breathing craft before or since.”

Peter W. Merlin,

Historian and Aerospace Archeologist, AIAA 2009-1022



“Everything about this airplane’s creation was gigantic: Kelly Johnson rightly regarded the Blackbird as the crowning triumph of his years at the Skunk Works’ helm. All of us who shared in its creation wear a badge of special pride. Nothing designed or built by any other aerospace operation in the world, before or since the Blackbird, can begin to rival its speed, height, effectiveness, and impact. Had we built Blackbird in the year 2010, the world would still have been awed by such an achievement. But the **first model, designed and built for the CIA as the successor to U-2, was being test-flown as early as 1962.** Even today, that feat seems nothing less than miraculous.”



Ben Rich, SKUNK WORKS: A Personal Memoir of My Years at Lockheed 1994, pp 192

It's the airplane, stupid!*

*from famous snowclone “It’s the economy, stupid.” James Carville, 1992

Section 6.2

Overarching Takeaways

It's the aerodynamics, stupid!*

***A Talented Engineer Can Do Wonders
Even with a Poor Tool!***

It's the airplane, not the tools, stupid!*

*from famous snowclone "*It's the economy, stupid.*" James Carville, 1992

Section 6.2: Key Takeaways

- **DNS is Seemingly the Only Path to Fully Effective ACA!**
 - Incredible reductions in turnaround times and total cost are required to produce **credible** solutions using DNS
 - Achieving high enough ‘Acceptance’ factors keep the effectiveness of DNS quite low in spite of its extremely high ‘Quality’ factor
 - Since DNS is not expected to be feasible—even for a wing—until around 2080, LES is probably a more promising option to explore for improving ACA effectiveness
- **LES for Improved Effectiveness—A Promising Midterm Strategy (2050+)**
 - Pace of progress closely tied to advances in grid generation; SGS models; algorithms; integrated software/hardware development; V&V; data management; etc.
- **RANS is here to stay! — A Conundrum for Today’s ACA Engineers**
 - “*the best modern methods allow almost all flows to be calculated to higher accuracy than the best-informed guess, which means that the methods are genuinely useful...*” Peter Bradshaw
 - TiCTaC—A Near Term Stopgap Strategy: Devise the best way of judiciously coupling wind-tunnel testing (WTT) with RANS CFD to deliver credible aerodynamic data—rapidly and affordably
 - No shortage of software suites: Commercial as well as “Free” Open Source
- **Not all codes are created equal—choose and use wisely!**

BIBLIOGRAPHY

SECTION 6

6 ACA Effectiveness: Status and Prospects (2000-20xx)

6.2 Prospects for Fully Effective ACA (2020–20xx)

- 6.2.1 Spalart, P., Reflections on RANS Modeling, June-August 2012. <https://www.cespr.fsu.edu/people/myh/CFD-Conference/Session-4/Philippe-Spalart-Presentation.pdf>
- 6.2.2 Richardson, L.F., “Weather Prediction by Numerical Process,” The University Press, Cambridge, UK, 1922, p. 66.
- 6.2.3 Sinha, N., “Towards RANS Parameterization of Vertical Mixing by Langmuir Turbulence in Shallow Coastal Shelves,” Ph.D. Dissertation, Nov. 2013. DOI: [10.13140/RG.2.2.26443.90404](https://doi.org/10.13140/RG.2.2.26443.90404)
- 6.2.4 Carton de Wiart, C., and Hillewaert, K., “DNS and ILES of transitional flows around a SD7003 using a high order Discontinuous Galerkin Method,” ICCFD7-2012-3604, Seventh International Conference on Computational Fluid Dynamics, Big Island, Hawaii, 9-13 July 2012. https://www.iccfd.org/iccfd7/assets/pdf/papers/ICCFD7-3604_paper.pdf
- 6.2.5 Uranga, A., Persson, P-O, Drela, M., and Peraire, J., “Implicit Large Eddy Simulation of Transitional Flows Over Airfoils and Wings,” AIAA 2009-4131, 19th AIAA Computational Fluid Dynamics Conference, San Antonio, TX, 22-25 June 2009. <https://doi.org/10.2514/6.2009-4131>
- 6.2.6 Piomelli, U., “Large eddy simulation in 2030 and beyond,” Philosophical Transactions of the Royal Society A, Volume 372, Issue 2022, 13 August 2014. <https://doi.org/10.1098/rsta.2013.0320>
- 6.2.7 Witherden, F.D., and Jameson, A., “Future Directions of Computational Fluid Dynamics,” AIAA 2017-3791, 23rd Computational Fluid Dynamics Conference, AIAA AVIATION Forum, Denver, Colorado, 5-9 June 2017. <https://arc.aiaa.org/doi/10.2514/6.2017-3791>
- 6.2.8 Slotnick, J., Khodadoust, A., Alonso, J., Darmofal, D., Gropp, W., Lurie, E., and Mavriplis, D., “CFD Vision 2030 Study: A Path to Revolutionary Computational Aerosciences,” NASA/CR-2014-218178, March 2014. <https://permanent.access.gpo.gov/gpo53497/20140003093.pdf>
- 6.2.9 Raj, P., “Aerodynamic Flight Prediction: A Perspective,” NASA/DoD Workshop on Aerodynamic Flight Prediction, Williamsburg, VA, 19-21 November 2002.
- 6.2.10 Raj, P., “CFD for Aerodynamic Flight Performance Prediction: From Irrational Exuberance to Sobering Reality (Invited),” 5th Symposium on Integrating CFD and Experiments in Aerodynamics, Tokyo, Japan, October 3-5, 2012.
- 6.2.11 Raj, P. and Friedman, A., “On timely and cost-effective prediction of aerodynamic data to meet aircraft design needs,” Paper H.1, RAeS Applied Aerodynamics Conference, Bristol, UK, July 22-24, 2014.
- 6.2.12 Raj, P. and Choi, S., “TiCTaC: An Innovative Paradigm for Aerodynamic Data Generation to Meet Aircraft Conceptual Design Needs,” Paper C.2, RAeS Applied Aerodynamics Conference, Bristol, UK, July 19-21, 2016.

	Slide #
Preface	3
1. Introduction and Scope	11
2. Genesis of Fluid Dynamics (<i>Antiquity to 1750</i>)	52
3. Fluid Dynamics as a Mathematical Science (<i>1750–1900</i>)	77
4. Emergence of Computational Fluid Dynamics (<i>1900–1950</i>)	98
5. Evolution of Applied Computational Aerodynamics (<i>1950–2000</i>)	124
5.1 <i>Infancy through Adolescence (1950–1980)</i>	127
Level I: Linear Potential Methods (LPMs)	127
Level II: Nonlinear Potential Methods (NPMs)	138
5.2 <i>Pursuit of Effectiveness (1980–2000)</i>	163
Level III: Euler Methods	167
Level IV: Reynolds-Averaged Navier-Stokes (RANS) Methods	210
6. ACA Effectiveness: Status and Prospects (<i>2000 and Beyond</i>)	229
6.1 <i>Assessment of Effectiveness (2000–2020)</i>	231
6.2 <i>Prospects for Fully Effective ACA (Beyond 2020)</i>	261
7. Closing Remarks	286
Appendix A	295

Pursuit of Effective Applied Computational Aerodynamics (ACA) Started Long Ago...

“Both for engineering and for many of the less exact sciences, such as biology, there is a demand for rapid methods, easy to be understood and applicable to unusual equations and irregular bodies. If they can be accurate, so much the better; but 1 per cent, would suffice for many purposes.” – Richardson, 1910

“Prospective users...rarely interested in whether or not an accurate solution of an idealized problem can be obtained, but are concerned with how well the calculated flow agrees with the real flow.” – Hess and Smith, 1967

“The effectiveness of computational aerodynamics depends not only on the accuracy of the codes but to a very large degree—perhaps more than is generally appreciated—on their robustness, ease and economy of use.” – Miranda, 1982

...and Continues Today!

ACA Effectiveness: Summary Status (circa 2020) and Prospects

***RANS-based ACA is Unlikely to be Fully Effective
Anytime Soon, If Ever!***

***DNS-based ACA May Lead to Fully Effective Capability
in the Long Term (2080+)
Many Decades Hence—A Bridge Too Far?***

***LES-based ACA Offers a Promising Alternative
in the Mid-term (2050+)***

***TiCTaC (Judicious Coupling of Wind Tunnel Testing and
RANS CFD) Offers a Near-term “Stopgap” Option***

Pursuit of Effectiveness: A Key Takeaway

Developing effective capability from research concepts is a long, arduous process!

- **Effective Capability (High TRL): Slow Pace of Development**
 - **Demonstration of Mature Capabilities is Essential!** It requires extensive investigations of *Quality* and *Acceptance* tradeoffs. Overcoming challenges of software V&V, user training and timely incorporation of user feedback & demands is a *resource intensive undertaking*
 - **Achieving maturity is hard due to rapid pace of advances in enabling technologies!** Engineers have limited freedom to change technology-based building blocks chosen in the earliest stages of development. **"Final product" risks being perceived as obsolete—and most likely is!**
- **Research Concepts (Low TRL): Fast Pace of Progress**
 - **Demonstration of Basic Functionality is Sufficient**—typically *proof of concept!*
 - **Computers**—ever higher performance demonstrated on *few* standard benchmarks
 - **Scalar Processors:** Single instruction, single data--one instruction at a time on one data item (integers or floating point numbers)
 - **Vector Processors:** Single instruction, multiple data--single instruction *simultaneously* on multiple data items
 - **Serial Computing:** stream of instructions executed serially on one computer
 - **Parallel & Massively Parallel Computing:** many instructions carried out simultaneously on one or many computers depending on level of parallelism—instruction, data, or task
 - **Grids**—many competing methods constantly proposed for generating grids of various types
 - Structured, Single or Patched Multi-block, Embedded, Overlapping, Cartesian, Unstructured
 - Boundary conforming or non-boundary conforming with Hexahedral, Tetrahedral, or Polyhedral cells
 - **Algorithms/Solvers**—new & improved algorithms, each with upsides and downsides to solve governing equations of fluid flow
 - Explicit, Implicit, Central difference, Upwind difference, Low order, High order, Cell centered, Node centered, Face centered, Multigrid, Grid Adaptive, etc.

Top Ten Takeaways

From My Journey on a Long and Winding Road

1. ACA is an engineering discipline that is enabled by CFD

- ACA adds value by meeting customer's most pressing needs—on time, on budget by delivering *credible solutions*
- *CFD is to ACA as airplane is to air transportation*

2. ACA and CFD aren't synonymous

- CFD produces data, ACA produces solutions — *don't confuse data with solution!*

3. EFD remains the best source of data to assess CFD 'goodness'

- If CFD and EFD data don't match, ask why? If they do, *most definitely ask why?*

4. Effectiveness is the best Measure of Merit for Assessing ACA

- Effectiveness = quality x acceptance: $E = Q \times A$
- *ACA Effectiveness is ultimately assessed by design teams (who initiate the "Value Chain"), not by CFD code developers, in collaboration with ACA engineers*

5. Predicting aerodynamic characteristics isn't that hard

- Generating credible predictions is—and it's REALLY HARD!



Top Ten Takeaways (contd.)

From My Journey on a Long and Winding Road

6. Converting a basic research concept into an *effective* capability is a long and arduous process marked by *invention, initiative, and innovation...and lots of patience!*
7. Success requires communication & collaboration across all stakeholders to *simultaneously* improve quality of results and productivity of processes
8. A *talented engineer* can do wonders even with poor tools
 - Talent trumps tools, any day of the week! Talent with tools—makes the impossible possible! *It's the airplane, not the tools, stupid!*
 - CFD competency is necessary but not sufficient to an effective ACA engineer. *It's the aerodynamics, stupid!*
9. Nothing—*absolutely nothing*—is worth compromising your integrity
10. Life is akin to an unsteady system with unsteady boundary conditions, *don't expect a steady solution*
 - *Don't underestimate the role of luck!*

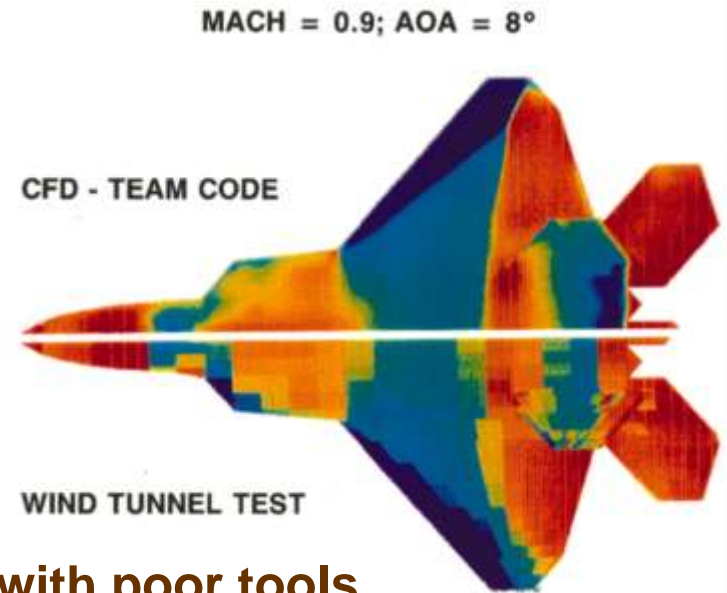

Lewis, Michael, “Don’t Eat Fortune’s Cookie,” Princeton University’s 2012 Baccalaureate Remarks
<https://www.princeton.edu/news/2012/06/03/princeton-universitys-2012-baccalaureate-remarks>

Be Mindful of Four “Immutable” Laws and Principles!

Murphy’s Law

"If anything can go wrong, it will."

Parkinson’s Law

“Work expands so as to fill the time available for its completion.”

The Peter Principle

“In a hierarchy, every employee tends to rise to his level of incompetence.”

The Dilbert Principle

“Companies tend to systematically promote their least-competent employees to management (generally middle management) in order to limit the amount of damage they are capable of doing.”

You will never be disappointed in your professional life!

***“Look ahead where the horizons are
absolutely unlimited”***



Robert E. Gross

Entrepreneur, Industrialist

Founder, Lockheed Aircraft Corporation (now Lockheed Martin)

Enshrinee, The National Aviation Hall of Fame

11 May 1897 – 3 Sep 1961

DEDICATED TO LUIS R. MIRANDA

Father of $E = Q \times A$

My mentor, adviser, coach

Aerodynamics Engineer par excellence

A consummate professional and a model leader



(Carlsbad, California, January 2016)

	Slide #
Preface	3
1. Introduction and Scope	11
2. Genesis of Fluid Dynamics (<i>Antiquity to 1750</i>)	52
3. Fluid Dynamics as a Mathematical Science (<i>1750–1900</i>)	77
4. Emergence of Computational Fluid Dynamics (<i>1900–1950</i>)	98
5. Evolution of Applied Computational Aerodynamics (<i>1950–2000</i>)	124
5.1 <i>Infancy through Adolescence (1950–1980)</i>	127
Level I: Linear Potential Methods (LPMs)	127
Level II: Nonlinear Potential Methods (NPMs)	138
5.2 <i>Pursuit of Effectiveness (1980–2000)</i>	163
Level III: Euler Methods	167
Level IV: Reynolds-Averaged Navier-Stokes (RANS) Methods	210
6. ACA Effectiveness: Status and Prospects (<i>2000 and Beyond</i>)	229
6.1 <i>Assessment of Effectiveness (2000–2020)</i>	231
6.2 <i>Prospects for Fully Effective ACA (Beyond 2020)</i>	261
7. Closing Remarks	286
Appendix A	295

Appendix A

Quasi-quantitative Approach for Assessing ACA Effectiveness

Quasi-quantitative Approach for Assessing ACA Effectiveness

The proposed quasi-quantitative approach defines an *effectiveness index (E)* as a composite of *quality index (Q)* and *acceptance index (A)*

$$E = Q \times A$$

- *Effectiveness index (E)* is the outcome/result of effectiveness assessment
- *Quality index (Q)* represents the level of ‘credibility’ of data generated by the computational simulations **for a target application**
 - ‘Credibility’ of data is a function of two factors: *Accuracy* and *Realism*
 - *Accuracy*—the degree to which the results of numerical simulations match the correct or exact values (*verification*)
 - *Realism*—the degree to which computational results represent reality (*validation*)
- *Acceptance index (A)* represents the level of ‘acceptability’ of a simulation by users and customers **for a target application**
 - ‘Acceptability’ is a function of four factors: *applicability*, *usability*, *affordability*, and *responsiveness*
 - *Applicability*—the degree to which a procedure is applicable to the problem at hand
 - *Usability*—how easy the procedure is for [‘non-expert’] users to use
 - *Affordability*—lower the cost [labor + computer], higher the affordability of simulations
 - *Responsiveness*—lower the turnaround time [elapsed time from go-ahead to data delivery], higher the responsiveness to customer needs

Quality Index (Q) Estimation

Quality index (Q) represents the level of ‘credibility’ of a computational simulation **for a target application** which is a function of **Accuracy** and **Realism**

- **Accuracy**—the degree to which numerical results match the correct value
- **Realism**—the degree to which computational results represent reality

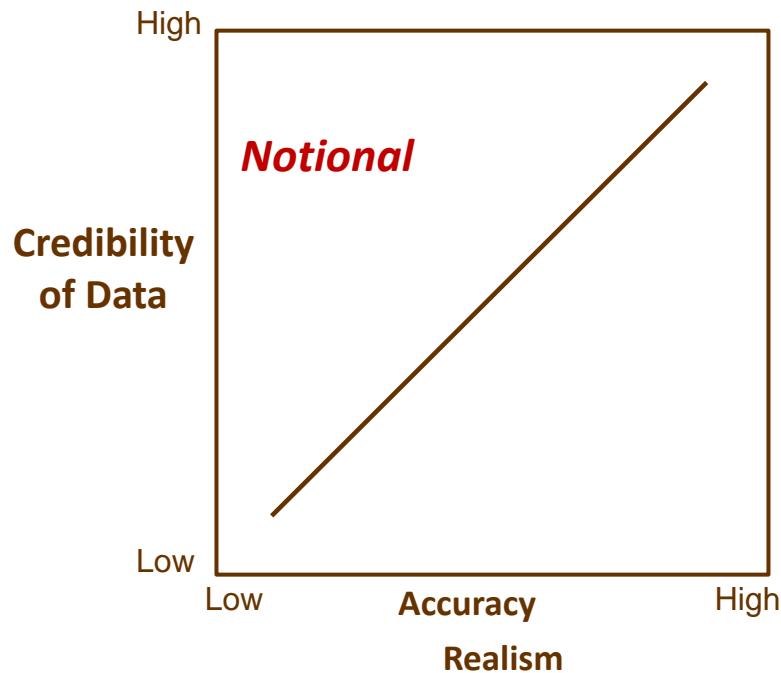

**Higher the credibility,
higher the Q**

Quality Index,
$$Q = \sum_{i=1}^2 W_i S_i$$

Factors	Weights (W_i)	Score (S_i)
1. Accuracy		
2. Realism		

Weight Scheme (W_i)

$$0 \leq W_i \leq 1$$

$$\sum_{i=1}^N W_i = 1$$

Scoring Scheme (S_i)

Low	0 – 0.4
Medium	0.4 – 0.7
High	0.7 – 1.0

Users select relative weights and assign scores for the two factors

Acceptance Index (A) Estimation

Acceptance index (A) represents the level of ‘acceptability’ of computational simulation by users and customers for a target application, and is a function of applicability, usability, affordability, and responsiveness

- *Applicability*—the degree to which a method is suitable for the problem at hand
- *Usability*—how easy a computational procedure is for [‘non-expert’] users to use
- *Affordability*—lower the cost (labor + computer), higher the affordability
- *Responsiveness*—lower the turnaround time (elapsed time from go-ahead to data delivery), higher the responsiveness

$$\text{Acceptance Index, } A = \sum_{i=1}^4 W_i S_i$$

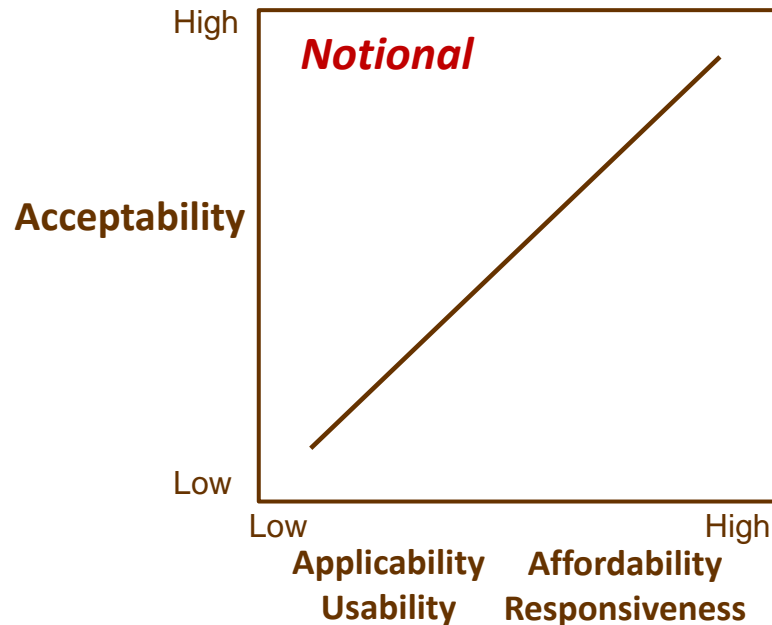

Users select relative weights and assign scores for the four factors

Higher the acceptability, higher the A

Factors	Weight (W_i)	Score (S_i)
1. Applicability		
2. Usability		
3. Affordability		
4. Responsiveness		

Weight Scheme (W_i)

$$0 \leq W_i \leq 1$$

$$\sum_{i=1}^N W_i = 1$$

Scoring Scheme (S_i)

Low	0 – 0.4
Medium	0.4 – 0.7
High	0.7 – 1.0

Effectiveness Index (E)

$$E = Q \times A$$

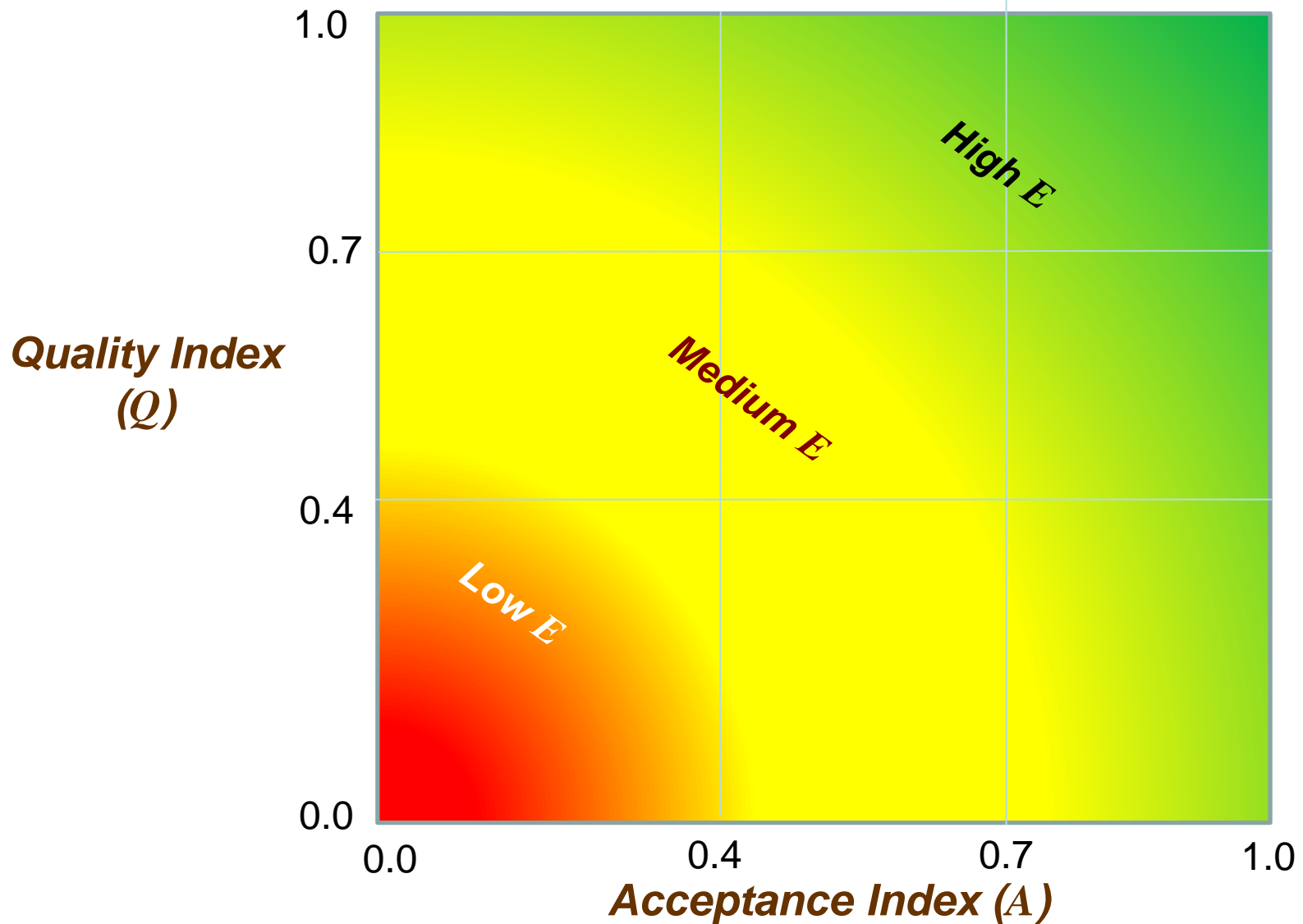

ACKNOWLEDGMENTS

The author has been incredibly fortunate to have had many excellent opportunities to learn from a large number of high-caliber individuals over the past six decades.

These individuals are too numerous to name, but they know who they are. He is eternally grateful to each of them for their generous guidance, advice, and support.

Pradeep Raj is currently a collegiate professor emeritus in the Kevin T. Crofton Department of Aerospace and Ocean Engineering at Virginia Tech in Blacksburg, Virginia, USA. Since 2012 through 2024, his primary responsibilities at VT included (a) teaching the AOE undergraduate Capstone Aircraft Design courses, and (b) pursuing collaborative research in multidisciplinary analysis, design, and optimization (MADO) tools and processes, with emphasis on applied aerodynamics, to enable simulation based design of affordable flight vehicles.

Raj joined VT in 2012 after a 32-year career with Lockheed Martin. Starting out in 1979 as a Senior Aerodynamics Engineer at the Lockheed-California Company in Burbank, he assumed positions of increasing responsibility before retiring in 2011 as a Director from Advanced Development Programs, Palmdale, California, commonly known as the Skunk Works® and widely recognized for creating breakthrough technologies and landmark aircraft. For the first 20 years, including 8 as Technical Fellow (1991-1999), Pradeep was instrumental in enhancing the effectiveness of applied computational aerodynamics for aircraft design through several research, development, and application campaigns.

Prior to joining LM, Raj spent one year (1978-79) as an assistant professor at the University of Missouri-Rolla (now Missouri Science & Technology University), and two years (1976-78) as a research assistant professor at the Iowa State University, Ames, Iowa. Pradeep earned his Ph.D. in Aerospace Engineering from Georgia Tech in 1976. Before going to GT, he earned a Master of Engineering (with Distinction) in Aeronautical Engineering in 1972, and a Bachelor of Engineering (with Distinction) in Electrical Technology in 1970, both from the Indian Institute of Science, Bangalore, India. He received a Bachelor of Science (with Honors) from Meerut University in 1967.

Pradeep Raj is a Fellow of the American Institute of Aeronautics and Astronautics (AIAA), of the Royal Aeronautical Society (RAeS), and of the Institute for the Advancement of Engineering (IAE).

https://www.aoe.vt.edu/people/emeritus/raj/personal-page/curriculum_vitae.html